

MILLEN[®]

430

TERMÉKKATALÓGUS

general catalogue

catalogue général

2024



1918

MILAN

MILAN

MILAN

MILAN

MILAN

MILAN
430

MILAN
430

MILAN
430

**RADÍROK ÉS HEGYEZŐK
ERASERS AND SHARPENERS
GOMMES À EFFACER ET TAILLE-CRAYONS**

- 10 **RADÍROK** · ERASERS · GOMMES À EFFACER
32 **BLSZTERES TERMÉKEK** · BLISTER PACKS · BLISTERS
34 **HEGYEZŐ+RADÍROK** · ERASERS WITH SHARPENER ·
GOMMES AVEC TAILLE-CRAYONS
45 **HEGYEZŐK** · SHARPENERS · TAILLE-CRAYONS

ÍRÁS · WRITING · ÉCRITURE

- 52 **GOLYÓSTOLLAk** · PENS · STYLOS
62 **NYOMÓSIRÓNOK** · MECHANICAL PENCILS · PORTE-MINES
70 **GRAFIT CERUZÁK** · GRAPHITE PENCILS · CRAYONS GRAPHITE
78 **SZÍNES CERUZÁK** · COLOUR PENCILS · CRAYONS DE COULEUR
92 **ZSÍRKRÉTÁK**
94 **FILCTOLLAk** · FIBREPENS · FEUTRES
104 **KRÉTAMARKEREK, TÁBLAÍRÓ-, ALKOHOLOS-, ÉS TÖRÖLHETŐ FILCTOLLAk**
PERMANENTES Y BORRABLES · FLUORESCENT MARKERS, FOR WHITEBOARD,
PERMANENTS AND ERASABLES · SURLIGNEURS FLUORESCENTS,
MARQUEURS POUR TABLEAU BLANC, PERMANENTS ET EFFAÇABLES
108 **KRÉTÁK** · CHALKS · CRAIES

**FESTÉKEK ÉS ECSETEK · PAINT AND BRUSHES ·
PEINTURE ET PINCEAUX**

- 112 **UJJFESTÉKEK ÉS TEMPERÁK** · FINGER PAINT AND POSTER PAINT
PEINTURE AU DOIGT ET GOUACHE
116 **AKRILFESTÉKEK ÉS VÍZFESTÉKEK** · ACRYLIC, WATERCOLOURS AND PASTELS
ACRYLIQUE, AQUARELLES ET PASTEL
121 **PAPÍR VISHEREK, RAJSZÉN ÉS FEHÉR MŰVÉSZ CERUZA** · BLENDING STUMPS,
CHARCOAL AND WHITE DRAWING PENCILS AND · ESTOMPES,
FUSAINS ET CRAYONS À DESSIN BLANCS
124 **ECSETEK** · BRUSHES · PINCEAUX
146 **KIEGÉSZÍTŐK** · ACCESSORIES · ACCESSOIRES

**KÉPZŐMŰVÉSZET ÉS FEJLESZTŐ JÁTÉKOK · HANDICRAFTS AND
EDUCATIONAL TOYS · TRAVAUX MANUELS ET JOUETS EDUCATIFS**

- 148 **TERMÉSZETES ÉS MODELLEZŐ GYURMÁK** · NATURAL CLAY AND MODELLING
DOUGH · ARGILE NATURELLE ET PÂTES À MODELER
150 **BÉLYEGZŐ BLOKK ÉS LINO METSZŐ** · CARVING BLOCKS AND SET
OF GOUGES FOR CARVING · PLAQUES DE GRAVURE ET
ENSEMBLE DE GOUGES POUR GRAVURE
151 **PAPÍR MACHÉ, SÓ-LISZT GYURMÁK ÉS FORMÁZÓ ESZKÖZÖK** · PAPER PULP POWDER,
MODELLING CLAY AND TOOLS · PAPIER MÂCHÉ EN POUDRE, PÂTES À MODELER
ET OUTILS POUR MODELAGE
161 **FÁBÓL KÉSZÜLT FEJLESZTŐ JÁTÉKOK** · WOODEN EDUCATIONAL TOYS
JOUETS EDUCATIFS EN BOIS



BELSŐ CSOMAGOLÁS
INNER BOX
SOUS-EMBALLAGE



KÜLSŐ CSOMAGOLÁS
OUTER CARTON
EMBALLAGE



**ELÉRHETŐ BLSZTERES
KIVITELBEN**
AVAILABLE IN BLISTER
PACK DISPONIBLE EN
BLISTER



EGYESÉVEL CSOMAGOLT
INDIVIDUALLY WRAPPED
EMBALLÉES INDIVIDUELLEMENT

**ISKOLAI- ÉS IRODAI KIEGÉSZÍTŐK
SCHOOL AND OFFICE ACCESSORIES
ACCESSOIRES SCOLAIRES ET DE BUREAU**

| | |
|---|-----|
| VONALZÓK · RULERS · RÈGLES | 166 |
| KÖRZŐK · COMPASSES · COMPAS | 171 |
| OLLÓK · SCISSORS · CISEAUX | 172 |
| KERÁMIA TAPÉTAVÁGÓK · CERAMIC CUTTER · CUTTER CÉRAMIQUE | 182 |
| RAGASZTÁS · GLUE · COLLE | 184 |
| HIBAJAVÍTÁS · CORRECTOR · CORRECTEURS | 188 |
| GÉMKAPOCS, TÉRKÉPTŰ, RAJZSZEG · CLIPS AND PINS | 193 |
| OLDALJELÖLŐK ÉS ÖNTAPADÓ JEGYZETTÖMBÖK · PAGE MARKERS AND ADHESIVE NOTES · MARQUE-PAGES ET NOTES ADHÉSIVES | 194 |
| TŰZŐKAPOCS, KAPOCSKISZEDŐ, TŰZŐGÉP ÉS LYUKASZTÓ · STAPLES, STAPLES REMOVER AND PUNCHES | 199 |
| RAGASZTÓSZALAGOK ÉS TÉPŐK · ADHESIVE TAPE AND TAPE DISPENSERS | 202 |

**SZÁMOLÓGÉPEK
CALCULATORS
CALCULATRICES**

| | |
|--|-----|
| TUDOMÁNYOS SZÁMOLÓGÉPEK | 208 |
| · SCIENTIFIC CALCULATORS · CALCULATRICES SCIENTIFIQUES | |
| ZSEBSZÁMOLÓGÉPEK | 212 |
| · POCKET CALCULATORS · CALCULATRICES DE POCHE | |
| ASZTALI SZÁMOLÓGÉPEK | 215 |
| DESKTOP CALCULATORS · CALCULATRICES DE BUREAU | |

**NAPLÓK
NOTEBOOKS
CARNETS**

| | |
|---|-----|
| NAPLÓK · PAPERBOOK · CARNETS | 222 |
| SPIRÁLFÜZETEK · NOTEBOOKS · CAHIERS | 224 |
| KULCSTARTÓK · KEY-RINGS · PORTE-CLÉS | 228 |

**KOLLEKCIÓK
COLLECTIONS
COLLECTIONS**

| | |
|---|-----|
| IZOTERMIKUS KULACSKOK · ISOTHERMAL BOTTLES · BOUTEILLES ISOTHERMES / | 229 |
| KULACSVÉDŐK · PROTECTIVE COVERS · HOUSSES PROTECTRICES / | |
| KOLLEKCIÓK · COLLECTIONS · COLLECTIONS / | |
| HÁTIZSÁKOK · BACKPACKS · SACS À DOS / | |
| TOLLTARTÓK · PENCIL CASES · | |
| IZOTERMIKUS UZSONNÁS TÁSKÁK · ISOTHERMAL FOOD BAGS · | |
| UZSONNÁS DOBOZOK · FOOD CONTAINERS · BOÎTES ALIMENTAIRES | |

**DISPLAYEK ÉS BLISZTERES TERMÉKEK
DISPLAYS AND BLISTERS
PRÉSENTOIRS ET BLISTERS**

| | |
|---|-----|
| DISPLAYEK · DISPLAYS · PRÉSENTOIRS | 261 |
| BLISZTERES TERMÉKEK · BLISTER PACKS · BLISTERS | 280 |



1 MIGA DE PAN

Puha szintetikus gumi radír, amely grafit ceruzák radirozását teszi lehetővé mindenféle papíron.

Soft synthetic rubber eraser, to erase a wide range of graphite pencils on all kinds of paper.

Gomme souple en caoutchouc synthétique permettant de gommer une large gamme de crayons graphite sur tous types de papiers.

2 MIGA DE PAN FLEXIBLE

Keményebb és sokkal flexibilisebb szintetikus radír. Grafit ceruzák radirozására alkalmas mindenféle papír felületen. Többféle radirozási intenzitást tesz lehetővé.

Harder and more flexible soft synthetic rubber eraser. To erase a wide range of graphite pencils on all kinds of paper. Different eraser intensities.

Gomme souple en caoutchouc synthétique, plus flexible et d'une plus grande résistance. Elle permet de gommer une large gamme de crayons graphite, sur tous types de papiers. Différentes intensités de gommage.

3 nata

Puha és sokoldalú, nem maszatoló radír. Mindenféle felületen használható. Nem sérti a papírt.

Soft, versatile, non-abrasive eraser. To erase on all types of surfaces. Does not damage the paper.

Gomme souple, versatile et non abrasive. Elle permet de gommer tous types de surfaces et n'abîme pas le papier.

4 CRISTAL

Kemény, de nem maszatoló, átlátszó műszaki radír. Műszaki rajzokhoz ideális.

Hard but non-abrasive transparent eraser. Suitable for technical drawing.

Gomme technique transparente, dure mais non abrasive. Indiquée pour les dessins linéaires.



5 THE MASTER GUM

Speciális radír képzőművészeti alkotásokhoz. Könnyen radíroz finom morzsákat képezve anélkül, hogy nagy nyomást kéne gyakorolni a papírra.

Használják még grafit- és szénrajzok összemosására is.

Special softer and more adsorbent eraser for FINE ARTS. Erases easily, without applying pressure to the paper, forming soft crumbs. Also used to blur charcoal and graphite drawings.

Gomme spécialement indiquée pour les BEAUX-ARTS, plus souple et plus adsorbante. Elle gomme facilement sans qu'il ne soit nécessaire d'exercer une forte pression sur le papier et forme des résidus souples. Elle est également utilisée pour estomper les dessins au fusain et au graphite.

6 MALEABLE

Formázható, nem vulkanizált radír, magas abszorbens erővel. Alkalmos grafitceruza és rajzszen radírozására. Nem sérti a munkafelületet.

Malleable non-vulcanized synthetic rubber eraser with high adsorption power, to erase charcoal and graphite. Clean erasing without shavings.

Gomme malléable en caoutchouc synthétique non vulcanisé, avec un grand pouvoir d'adsorption, indiquée pour gommer les traits de fusain et de graphite. Un gommage propre et sans résidu.

7 CAUCHO, DOBLE USO

Kétfelhasználású puha, abszorbens radír.

Double use eraser, made of synthetic rubber, soft and abrasive.

Gomme en caoutchouc synthétique, double usage. Une partie en matériel souple et l'autre abrasive.

8 CAUCHO

Műanyag abszorbens radír.

Abrasive synthetic eraser made of rubber.

Gomme en caoutchouc synthétique abrasive.

RADÍROK · ERASERS · GOMMES À EFFACER

TISZTÍTÓ PÁRNA

SAKEMBEREKNEK. Rugalmas pamutszövet, amely 120 grammnyi finom radírport tartalmaz. Papír és karton felületek tisztítására és felújítására szolgál.

FOR PROFESSIONALS. Elastic cotton fabric pouch. Contains 120 grams of fine powder of eraser crumbs. Intended for cleaning and restoration of paper and cardboard.

POUR PROFESSIONNELS. Coussin en coton élastique. Il contient 120 grammes d'une fine poussière de gomme mie de pain. Il est conseillé pour le nettoyage et la réparation de papiers et de cartons.



rendelési kód: F41199001

1
u./cajita
u./box
u./boîte

11,5 x 6,5 x 3,5 cm · 140 gr

40 boxes · 5,90 kg

SMM0120

8414034001209

ART 1

1. Fogja meg és finoman rázza meg a pamutszövetet, amíg meg nem jelenik a radírpórá. A tisztítandó területen alakítson ki egy vékony réteget!
2. Körkörös mozdulatokkal dolgozza meg a réteget egy ecset segítségével!
3. Távolítsa el a radírpórá a megtisztított területről!

1. Tighten and lightly shake the cleaning pouch until the eraser powder appears. Form a fine layer on the area to clean.
2. Extend the powder with a soft brush, making circular movements.
3. Remove the eraser powder from the cleaned surface.

1. Presser et secouer doucement le coussin nettoyeur jusqu'à ce que la poussière de gomme apparaisse. Former une fine couche sur la zone à nettoyer.
2. Étaler la poussière avec un pinceau souple en réalisant des mouvements circulaires.
3. Enlever la poussière de gomme de la surface nettoyée.



EXTRA PUHA 5020 DE NATA EXTRA SUAVE

Speciális radír puha ceruza vonalához. Morzsálékmentesen radíroz.

Special eraser for soft pencil lines. Erases without leaving shavings.

Spécialement conçue pour effacer les traits de crayon souple. Efface sans laisser de miettes.



EXPOSITORES
DISPLAYS
PRÉSENTOIR
PG. 262 >

EGYESÉVEL CSOMAGOLT
INDIVIDUALLY WRAPPED
EMBALLÉES INDIVIDUELLEMENT

rendelési kód: F41194020

20
u./cajita
u./box
u./boîte

12,6 x 12,4 x 2,9 cm · 0,50 kg

25 boxes · 12,90 kg

CPM5020

8414034650216

ART 3

TOP GRAPHIC
TOP GRAPHIC
Mod. 5020
6,1 x 2,3 x 1,2 cm

8414034650209>



MORZSALÉK
MENTES

RADÍROK · ERASERS · GOMMES À EFFACER

rendelési kód: F41151BL2



14 x 8,2 x 1,5 cm · 54 gr

25 units · 1,45 kg

BMM10314



8414034921422



5

u./cajita
u./box
u./boîte

12,5 x 5,5 x 1,5 cm · 122gr

24 boxes · 3,10 kg

CMM1420-05



8414034014209

THE MASTER GUM

Speciális radír képzőművészeti alkotásokhoz, simább és sokkal adszorbensebb. Könnyen radíroz finom morzsákat képezve anélkül, hogy nagy nyomást kéne gyakorolni a papírra. Használják még grafit- és szénrajzok összemosására is.

Special eraser for Fine Arts, smoother and more adsorbent. Erases easily, without requiring pressure on the paper, forming smooth crumbs. Also used to blend drawings with charcoal and graphite.

Gomme spéciale pour les Beaux-Arts, plus souple et plus adsorbante. Elle efface facilement en formant de légers résidus, sans qu'il ne soit nécessaire d'exercer une forte pression sur le papier. Elle s'utilise également pour estomper les dessins au fusain et au graphite.

EGYESÉVEL CSOMAGOLT
INDIVIDUALLY WRAPPED
EMBALLÉES INDIVIDUELLEMENT

rendelési kód: F41199002

5 ART

MASTER GUM
MASTER GUM

Mod. 1420

5,5 x 2,3 x 1,3 cm



8414034614218>

NEZD MEG A
VIDEÓT!



rendelési kód: MIL000488



14 x 8,2 x 2,5 cm · 29 gr

25 units · 0,89 kg

BCM1220C



8414034912208

**NEW
DESIGN!**



12

u./cajita
u./box
u./boîte

9,7 x 7,3 x 4 cm · 0,24 kg

24 units · 6,40 kg

CCM1220-12



8411574012212

GYURMARADÍR 1220

Nagy adszorpciós képesség szén- és grafitvonalak radírozásához. Formázható és morzsalékmentes.

Great power of adsorption, for erasing charcoal and graphite lines. Clean erasing without shavings.

Grand pouvoir d'adsorption, indiquée pour effacer des traits de fusain et de graphite. Un gommage propre et sans résidu.

EGYESÉVEL CSOMAGOLT
INDIVIDUALLY WRAPPED
EMBALLÉES INDIVIDUELLEMENT

rendelési kód: F41199020

6 ART

FORMÁZHATÓ
KNEADABLE

Mod. 1220

3,7 x 2,8 x 1 cm

8414034612207>



NEZD MEG A
VIDEÓT!



1. Fogja meg a radír egy részét és válassza le a többletét!
2. Formálja meg a leválasztott részt!
3. Gyengéden dörzsölje a radírozandó vonalakat!

1. Select part of the eraser and separate it from the rest.
2. Form a small mass.
3. Apply with a soft pressure on the line to be erased.

1. Sélectionner une partie de la gomme et la séparer du reste.
2. Former une petite masse.
3. Appliquer en exerçant une légère pression sur le trait à effacer.



RADÍROK · ERASERS · GOMMES À EFFACER



NEW!

EGYESÉVEL CSOMAGOLT
INDIVIDUALLY WRAPPED
EMBALLÉES INDIVIDUELLEMENT

rendelési kód: F41188006

2

FLEXIBILIS SZINTETIKUS RADÍR
FLEXIBLE SYNTHETIC RUBBER

Mod. 106

6,8 x 3,7 x 1,8 cm

8414034601065>



6
u./cajita
u./box
u./boîte

12 x 7,2 x 3,8 cm · 0,44 kg

25 boxes · 11,90 kg

CNM106



8414034001063



rendelési kód: F41188012

1

SZINTETIKUS RADÍR
SYNTHETIC FRIABLE RUBBER

Mod. 112

7,3 x 2,8 x 0,9 cm

8414034601126>



12
u./cajita
u./box
u./boîte

11,5 x 7,5 x 3 cm · 0,28 kg

25 boxes · 7,48 kg

CMM112



8414034001124



PG. 15/20 >

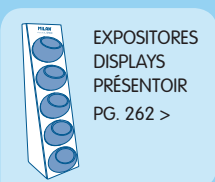

EXPOSITORES
DISPLAYS
PRÉSENTOIR
PG. 262 >

rendelési kód: MIL000829



12
u./cajita
u./box
u./boîte

11,5 x 7,5 x 3 cm · 0,30 kg

25 boxes · 7,90 kg

CMM1012



8414034010126



rendelési kód: F41187012

**TOP
SELLER**

1

SZINTETIKUS RADÍR
SYNTHETIC FRIABLE RUBBER

Mod. 1012

6,2 x 2,8 x 1,2 cm

8414034610128>



PG. 32



16 u./cajita
u./box
u./boîte

9 x 9 x 8 cm · 0,40 kg

14 boxes · 1,72 kg

CMM1012-16



8414034010331

EGYESÉVEL CSOMAGOLT
INDIVIDUALLY WRAPPED
EMBALLÉES
INDIVIDUELLEMENT

16 u./cajita
u./box
u./boîte

ø12 x 5,5 cm · 0,40 kg

12 cans · 5,29 kg

PMM1012CF-16



rendelési kód: MIL000002



rendelési kód: F41187024

**TOP
SELLER**

1

SZINTETIKUS RADÍR
SYNTHETIC FRIABLE RUBBER

Mod. 124

4,9 x 2,3 x 0,9 cm

8414034601249>



PG. 32



24
u./cajita
u./box
u./boîte

14 x 5,2 x 3,7 cm · 0,30 kg

25 boxes · 7,77 kg

CMM124



8414034001247

VÉDŐTOKOS RADÍROK · ERASERS WITH PROTECTIVE CASE · GOMMES À EFFACER AVEC ÉTUI



24
u./cajita
u./box
u./boîte

15,5 x 9,5 x 6cm · 0,70 kg

10 units · 7,40 kg

CMMFN1012



8414034010355



**THE
FUN**
SERIES

rendelési kód: F41187T24

VEGYES SZÍNEK

PATENTED DESIGN

6,4 x 4 x 1,5 cm

MIGA DE PAN
SYNTHETIC FRIABLE RUBBER

Mod. 1012

6,2 x 2,8 x 1,2 cm



24
u./cajita
u./box
u./boîte

15,5 x 9,5 x 6cm · 0,70 kg

10 units · 7,40 kg

CMMM1012



8414034010348



**SPECIAL
series**

rendelési kód: F41187M24

PATENTED DESIGN

6,4 x 4 x 1,5 cm

SZINETIKUS RADÍR
SYNTHETIC FRIABLE RUBBER

Mod. 1012

6,2 x 2,8 x 1,2 cm



12
u./cajita
u./box
u./boîte

13,5 x 6,5 x 6 cm · 0,40 kg

8 units · 3,30 kg

32 units · 13,60 kg

CMMS1012



8414034010133



acid
SERIES

rendelési kód: F41187S12

school 1012

PATENTED DESIGN

6,2 x 2,8 x 1,2 cm

SZINETIKUS RADÍR
SYNTHETIC FRIABLE RUBBER

Mod. 1012

6,2 x 2,8 x 1,2 cm



RADÍROK · ERASERS · GOMMES À EFFACER

EGYESÉVEL CSOMAGOLT
INDIVIDUALLY WRAPPED
EMBALLÉES INDIVIDUELLEMENT

rendelési kód: F41165020



**TOP
SELLER**

nata[®]

Mod. 320

6,1 x 2,3 x 1,2 cm



PG. 33

8414034603205>

3



20
u./cajita
u./box
u./boîte

12,5 x 12,4 x 2,9 cm · 0,59 kg

25 boxes · 15,25 kg

CPM320



8414034003203

VÉDŐTOKOS RADÍROK · ERASERS WITH PROTECTIVE CASE · GOMMES À EFFACER AVEC ÉTUI

rendelési kód: F41165120



office 320

PATENTED DESIGN

6,3 x 2,6 x 1,6 cm

nata[®]

Mod. 320

6,1 x 2,3 x 1,2 cm



3



20
u./cajita
u./box
u./boîte

13 x 13 x 3,5 cm · 0,61 kg

5 units · 3,15 kg

20 units · 13 kg

CPM01320



8414034013202



SERIES

A VÉDŐTOK BIOCIDOT TARTALMAZ. EZÜST-FOSZFÁT ÜVEGGEL KEZELVE
(CAS308069-39-8), ANTIBAKTERIÁLIS HATÁSÚ.

THE ERASER CASE INCORPORATES A BIOCID. TREATED WITH SILVER PHOSPHATE
GLASS (CAS 308069-39-8) WITH ANTIBACTERIAL EFFECT.

L'ÉTUI DE LA GOMME INCLUT UN BIOCID. TRAITÉ AU VERRE DE PHOSPHATE D'ARGENT
(CAS 308069-39-8) AVEC EFFET ANTIBACTÉRIEN.



office 320 +

6,3 x 2,6 x 1,6 cm

PATENTED DESIGN

nata[®]

Mod. 320

6,1 x 2,3 x 1,2 cm



3

rendelési kód: MIL000569



14 x 8,2 x 2 cm · 35 gr

12 units · 0,48 kg

BPM10457IBGP



8411574093572

rendelési kód: MIL000568



14 x 8,2 x 2 cm · 35 gr

12 units · 0,48 kg

BPM10457IBGGR



8411574093589

RADÍROK · ERASERS · GOMMES À EFFACER



20

u./cajita
u./box
u./boîte

12,5 x 12,4 x 2,9 cm · 0,58 kg

25 boxes · 14,70 kg

CNM320FN



8414034003258

EGYESÉVEL CSOMAGOLT
INDIVIDUALLY WRAPPED
EMBALLÉES INDIVIDUELLEMENT



2

VEGYES SZÍNEK

FELIXIBILIS SZINTETIKUS RADÍR
FLEXIBLE SYNTHETIC RUBBER

Mod. 320

6,1 x 2,3 x 1,2 cm

rendelési kód: F41165520



THE
FUN
SERIES



20

u./cajita
u./box
u./boîte

12,5 x 12,4 x 2,9 cm · 0,58 kg

25 boxes · 14,70 kg

CPM320SN



8414034003210

EGYESÉVEL CSOMAGOLT
INDIVIDUALLY WRAPPED
EMBALLÉES INDIVIDUELLEMENT



3

nata®

Mod. 320

6,1 x 2,3 x 1,2 cm



PG. 33

rendelési kód: F41165220

8414034603212>



SUNSET
SERIES



20

u./cajita
u./box
u./boîte

12,5 x 12,4 x 2,9 cm · 0,58 kg

25 boxes · 9,26 kg

CPM320CP



8414034003234

EGYESÉVEL CSOMAGOLT
INDIVIDUALLY WRAPPED
EMBALLÉES INDIVIDUELLEMENT



3

nata®

Mod. 320

6,1 x 2,3 x 1,2 cm



PG. 33

rendelési kód: F41165320

8414034603212>



COPPER
SERIES



20

u./cajita
u./box
u./boîte

12,5 x 12,4 x 2,9 cm · 0,58 kg

25 boxes · 14,70 kg

CPM320SL



8414034003227

EGYESÉVEL CSOMAGOLT
INDIVIDUALLY WRAPPED
EMBALLÉES INDIVIDUELLEMENT

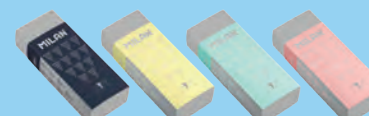

4

CRISTAL
CRISTAL

Mod. 320 SL

6,1 x 2,3 x 1,2 cm

rendelési kód: F41165420

8414034603274>



SILVER
SERIES

RADÍROK · ERASERS · GOMMES À EFFACER



EGYESÉVEL CSOMAGOLT
INDIVIDUALLY WRAPPED
EMBALLÉES INDIVIDUELLEMENT

rendelési kód: F41185003

1

SZINTETIKUS RADÍR
SYNTHETIC FRIABLE RUBBER

Mod. 403

6,8 x 5,1 x 2,8 cm

8414034604035>



3

u./cajita
u./box
u./boîte

15 x 12,5 x 3,2 cm · 0,48 kg

25 boxes · 11,27 kg

CMM403



8414034004033



EGYESÉVEL CSOMAGOLT
INDIVIDUALLY WRAPPED
EMBALLÉES INDIVIDUELLEMENT

rendelési kód: MIL000008

2

FLEXIBILIS SZINTETIKUS RADÍR
FLEXIBLE SYNTHETIC RUBBER

Mod. 406

6,8 x 3,9 x 1,8 cm

8414034604066>



6

u./cajita
u./box
u./boîte

12 x 7,2 x 3,8 cm · 0,44 kg

25 boxes · 11,90 kg

CNM406



8414034004064



EGYESÉVEL CSOMAGOLT
INDIVIDUALLY WRAPPED
EMBALLÉES INDIVIDUELLEMENT

rendelési kód: MIL000010

1

SZINTETIKUS RADÍR
SYNTHETIC FRIABLE RUBBER

Mod. 412

5,2 x 3,5 x 1,3 cm

8414034604134>



PG. 33



12

u./cajita
u./box
u./boîte

16,3 x 7,3 x 3,2 cm · 0,47 kg

25 boxes · 11,95 kg

CMM412CF



8414034004132



rendelési kód: F41185020

1

SZINTETIKUS RADÍR
SYNTHETIC FRIABLE RUBBER

Mod. 420

4,1 x 2,8 x 1,3 cm

8414034614201>



PG. 32



20

u./cajita
u./box
u./boîte

14,3 x 8,9 x 2,8 cm · 0,50 kg

25 boxes · 13 kg

CMM420



8414034004200

RADÍROK · ERASERS · GOMMES À EFFACER



24
u./cajita
u./box
u./boîte

15,8 x 6,8 x 5,5 cm - 0,48 kg

25 boxes - 12,40 kg

CMM424A



8414034004248

rendelési kód: F41191024

1



SZINETIKUS RADÍR
SYNTHETIC FRIABLE RUBBER

Mod. 424-A

3,9 x 2,3 x 1,3 cm

8414034604240 >

TOP SELLER



30
u./cajita
u./box
u./boîte

14,3 x 8,9 x 2,8 cm - 0,51 kg

25 boxes - 13,10 kg

CMM430



8414034004309



PG. 19-20 >

rendelési kód: F41185030

1



SZINETIKUS RADÍR
SYNTHETIC FRIABLE RUBBER

Mod. 430

2,8 x 2,8 x 1,3 cm

PG. 32

TOP SELLER



VÉDŐTOKOS RADÍROK · ERASERS WITH PROTECTIVE CASE · GOMMES À EFFACER AVEC ÉTU



30
u./cajita
u./box
u./boîte

10 x 9,5 x 7 cm - 0,70 kg

4 units - 2,90 kg

12 units - 9,00 kg

CMMS430SL



8414034010263



SILVER SERIES

school 430

PATENTED DESIGN

3,4 x 3,2 x 1,9 cm

rendelési kód: F41185030SL

1

SZINETIKUS RADÍR
SYNTHETIC FRIABLE RUBBER

Mod. 1012

2,8 x 2,8 x 1,3 cm



60
unidades/bote
units/can
unités/pot

15,1 x 12,5 x 12,5 cm - 1,5 kg

1 unit - 1,55 kg

6 units - 9,80 kg

PMMS430LK



8414034010195

x2



VEGYES SZÍNEK

rendelési kód: MIL000810

14 x 8,2 x 2 cm - 64 gr

12 units - 0,90 kg

BYM10330



8411574058830



look SERIES

school 430

PATENTED DESIGN

3,4 x 3,2 x 1,9 cm

rendelési kód: F41185030LK

1

SZINETIKUS RADÍR
SYNTHETIC FRIABLE RUBBER

Mod. 1012

2,8 x 2,8 x 1,3 cm



VÉDŐTOKOS RADÍROK · ERASERS WITH PROTECTIVE CASE · GOMMES À EFFACER AVEC ÉTUI

1918

SERIES

NEW!

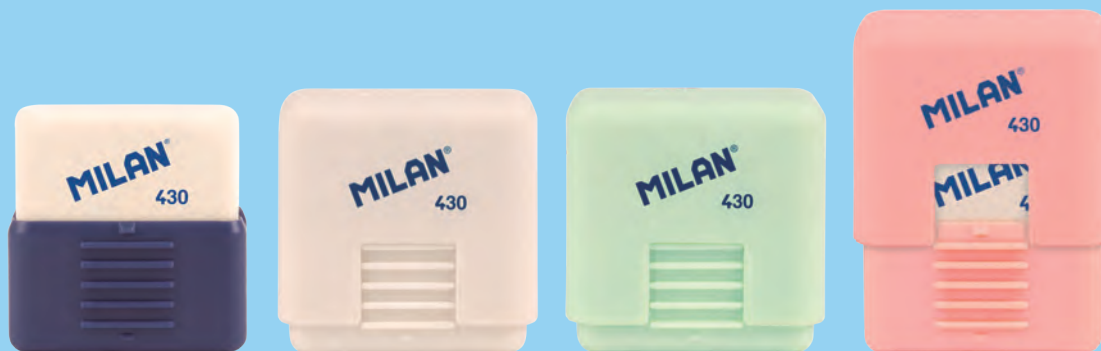

rendelési kód: F41185030SE

school 430

PATENTED DESIGN

3,4 x 3,2 x 1,9 cm



SZINETIKUS RADÍR
SYNTHETIC FRIABLE RUBBER

Mod. 430

2,8 x 2,8 x 1,3 cm



30 u./cajita
u./box
u./boîte

10 x 9,5 x 7 cm · 0,70 kg

4 units · 2,90 kg

12 units · 9,00 kg

CMMS430SNC



8414034010324

"SEPRŰS" RADÍROK · ERASERS WITH BRUSH · GOMMES À EFFACER AVEC BROSSE

rendelési kód: F41170BRS



THE
FUN
SERIES

SPECIAL
series



COMPACT

PATENTED DESIGN

4,9 x 3,7 x 2,2 cm

SZINETIKUS RADÍR
SYNTHETIC FRIABLE RUBBER

Mod. 430

2,8 x 2,8 x 1,3 cm



x1

VEGYES SZÍNEK

16 u./cajita
u./box
u./boîte

15,7 x 9,5 x 5 cm · 0,54 kg

10 units · 5,5 kg

20 units · 11,30 kg

4901116FA



8411574095651



rendelési kód: MIL000826

14 x 8,2 x 2,2 cm · 58 gr

12 units · 0,70 kg

BYM10472FA



8411574096047



NEW
LOOK
SERIES



CAPSULE

PATENTED DESIGN

5,3 x 3,5 x 1,8 cm

SZINETIKUS RADÍR
SYNTHETIC FRIABLE RUBBER

Mod. 1012

6,2 x 2,8 x 1,2 cm



16 u./cajita
u./box
u./boîte

14,5 x 8 x 5,5 cm · 0,38 kg

10 units · 4,10 kg

20 units · 8,50 kg

4900116LK2



8411574095637

rendelési kód: F41169BRS

RADÍROK · ERASERS · GOMMES À EFFACER



36

u./cajita
u./box
u./boîte

15,8 x 6,8 x 5,5 cm · 0,45 kg

25 boxes · 11,9 kg

CNM436A



8414034014360

2



EGYESÉVEL CSOMAGOLT
INDIVIDUALLY WRAPPED
EMBALLÉES INDIVIDUELLEMENT

**TOP
SELLER**

FLEXIBILIS SZINETIKUS RADÍR
FLEXIBLE SYNTHETIC RUBBER

Mod. 436-A

3,9 x 2,3 x 0,9 cm



PG. 32

rendelési kód: F41176036

8414034604363>



45

u./cajita
u./box
u./boîte

16,1 x 7,3 x 3 cm · 0,50 kg

25 boxes · 12,78 kg

CMM445



8414034044510

1



SZINETIKUS RADÍR
SYNTHETIC RUBBER

Mod. 445

3,1 x 2,3 x 0,9 cm



PG. 32

**TOP
SELLER**

rendelési kód: F41193045



60

u./cajita
u./box
u./boîte

16,2 x 7,3 x 3 cm · 0,48 kg

25 boxes · 12,30 kg

CNM460



8414034004606

2



FLEXIBILIS SZINETIKUS RADÍR
FLEXIBLE SYNTHETIC RUBBER

Mod. 460

3,1 x 2,3 x 0,7 cm

**TOP
SELLER**

rendelési kód: F41185060



18

u./cajita
u./box
u./boîte

10,5 x 10,5 x 4,1 cm · 0,68 kg

25 boxes · 17,34 kg

CMM4018



8414034040185

1



**TOP
SELLER**

SZINETIKUS RADÍR
SYNTHETIC RUBBER

Mod. 4018

5,2 x 3,5 x 1,3 cm



PG. 32

rendelési kód: F41189018

8414034640187>



RADÍROK · ERASERS · GOMMES À EFFACER



rendelési kód: MIL000017

2

**TOP
SELLER**

FLEXIBILIS SZINETIKUS RADÍR
FLEXIBLE SYNTHETIC RUBBER

Mod. 4840

5,2 x 1,9 x 0,8 cm

8414034648404>



40

u./cajita
u./box
u./boîte

11,5 x 10,4 x 3,3 cm · 0,42 kg

25 boxes · 10,70 kg

CNM4840



8414034048402



rendelési kód: F41152036

2

EGYESÉVEL CSOMAGOLT
INDIVIDUALLY WRAPPED
EMBALLÉES INDIVIDUELLEMENT

FLEXIBILIS SZINETIKUS RADÍR
FLEXIBLE SYNTHETIC RUBBER

Mod. 4036

3,9 x 2 x 0,8 cm

8414034640361>



36

u./cajita
u./box
u./boîte

16,3 x 6,1 x 2,5 cm · 0,37 kg

25 boxes · 10,15 kg

CNM4036



8414034040369



rendelési kód: F41193060

2

**TOP
SELLER**



FLEXIBILIS SZINETIKUS RADÍR
FLEXIBLE SYNTHETIC RUBBER

Mod. 4060

2,8 x 1,9 x 1 cm



60

u./cajita
u./box
u./boîte

14 x 8 x 3 cm · 0,49 kg

25 boxes · 12,60 kg

CNM4060



8414034040604



rendelési kód: F41192024

1



SZINETIKUS RADÍR
SYNTHETIC FRIABLE RUBBER

Mod. 4424

3,9 x 2,3 x 1,3 cm

8414034644246>



rendelési kód: F41192D80



80

u./bote
u./can
u./pot

17,5 x 17,4 x 11,8 cm · 1,78 kg

4 boxes · 7,50 kg

PMM4424/80



8414034044251

24

u./cajita
u./box
u./boîte

15,8 x 6,8 x 5,5 cm · 0,46 kg

25 boxes · 12,30 kg

CMM4424



8414034044244

RADÍROK · ERASERS · GOMMES À EFFACER



24
u./cajita
u./box
u./boîte

16 x 7,2 x 3,2 cm · 0,46 kg

25 boxes · 12,23 kg

CMM2424



8414034024246

EGYESÉVEL CSOMAGOLT
INDIVIDUALLY WRAPPED
EMBALLÉES INDIVIDUELLEMENT

rendelési kód: F41177024

1

SZINTETIKUS RADÍR
SYNTHETIC FRIABLE RUBBER

Mod. 2424

3,9 x 2,3 x 1,3 cm



8414034624248>



rendelési kód: MIL000830



10
u./cajita
u./box
u./boîte

12,8 x 6 x 3,2 cm · 0,29 kg

25 boxes · 14,71 kg

CMM4020-10



8414034040208



20
u./cajita
u./box
u./boîte

11,5 x 10,4 x 3,3 cm · 0,56 kg

25 boxes · 14,71 kg

CMM4020



8414034640217

EGYESÉVEL CSOMAGOLT
INDIVIDUALLY WRAPPED
EMBALLÉES INDIVIDUELLEMENT

rendelési kód: F41178020

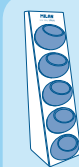

EXPOSITORES
DISPLAYS
PRÉSENTOIR
PG. 262 >

1

SZINTETIKUS RADÍR
SYNTHETIC FRIABLE RUBBER

Mod. 4020

5,5 x 2,3 x 1,3 cm



PG. 33

8414034640200>



TOP
SELLER



20
u./cajita
u./box
u./boîte

11,5 x 10,4 x 3,3 cm · 0,56 kg

25 boxes · 14,71 kg

CMM4020A



8414034040215

EGYESÉVEL CSOMAGOLT
INDIVIDUALLY WRAPPED
EMBALLÉES INDIVIDUELLEMENT

rendelési kód: F41181020



1

SZINTETIKUS RADÍR
SYNTHETIC FRIABLE RUBBER

Mod. 4020

5,5 x 2,3 x 1,3 cm



8414034640224>



rendelési kód: MIL000831



10
u./cajita
u./box
u./boîte

12,5 x 5,3 x 2,2 cm · 0,18 kg

24 boxes · 4,50 kg

CNM4024-10



8414034040314



24
u./cajita
u./box
u./boîte

11,5 x 10,4 x 3,3 cm · 0,42 kg

25 boxes · 10,96 kg

CNM4024



8414034040307

EGYESÉVEL CSOMAGOLT
INDIVIDUALLY WRAPPED
EMBALLÉES INDIVIDUELLEMENT

rendelési kód: F41159020

2

FLEXIBILIS SZINTETIKUS RADÍR
FLEXIBLE SYNTHETIC RUBBER

Mod. 4024

5 x 2,3 x 0,9 cm

8414034640248>



RADÍROK · ERASERS · GOMMES À EFFACER



rendelési kód: F41195065

2



FLEXIBILIS SZINETIKUS RADÍR
FLEXIBLE SYNTHETIC RUBBER

Mod. 4865

3,6 x 3,3 x 0,6 cm

8414034600655>



65 u./cajita
u./box
u./boîte

9 x 9 x 8 cm · 0,47 kg

4 boxes · 2,04 kg

CNM4865



8414034010683



rendelési kód: F41186045

1



SZINETIKUS RADÍR
SYNTHETIC FRIABLE RUBBER

Mod. 4045

3,9 x 3,4 x 0,9 cm

8414034640453>



PG. 32



45 u./cajita
u./box
u./boîte

9 x 9 x 8 cm · 0,46 kg

4 boxes · 1,98 kg

CMM4045



8414034014254



rendelési kód: F41186028

1



SZINETIKUS RADÍR
SYNTHETIC FRIABLE RUBBER

Mod. 428

5,1 x 4,6 x 1,3 cm

8414034604288>



PG. 32



28 u./cajita
u./box
u./boîte

10 x 9,9 x 9,2 cm · 0,74 kg

9 boxes · 7,02 kg

CMM428



8414034994358

rendelési kód: F41195036



Cod.PNM4836RCF
EGYESÉVEL CSOMAGOLT
INDIVIDUALLY WRAPPED
EMBALLÉES INDIVIDUELLEMENT

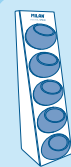

EXPOSITORES
DISPLAYS
PRÉSENTOIR
PG. 262 >

NÉZD MEG
A VIDEÓT!



2



FLEXIBILIS SZINETIKUS RADÍR
FLEXIBLE SYNTHETIC RUBBER

Mod. 4836

5 x 4,4 x 0,7 cm

8414034614256>

rendelési kód: MILO000003



36 u./bote
u./can
u./pot

Ø 12 x 4,3 cm · 0,48 kg

18 cans · 8,88 kg

PNM4836RCF



8414034014384



36 u./cajita
u./box
u./boîte

10 x 9,9 x 9,2 cm · 0,48 kg

9 boxes · 4,75 kg

CNM4836B



8414034014452

RADÍROK · ERASERS · GOMMES À EFFACER



24

u./cajita
u./box
u./boîte

12 x 7,2 x 4,2 cm · 0,57 kg

20 boxes · 11,80 kg

CNM4824



8414034048242

rendelési kód: MIL000011

2

FLEXIBILIS SZINTETIKUS RADÍR
FLEXIBLE SYNTHETIC RUBBER

Mod. 4824

7,4 x 2 x 1 cm

8414034600235>



12

u./cajita
u./box
u./boîte

11 x 8 x 3,1 cm · 0,38 kg

25 boxes · 9,80 kg

CPM612



8414034006129

rendelési kód: F41163012

3

nata®

Mod. 612

7,8 x 2,3 x 1,2 cm

8414034606121>



PG. 33

TOP
SELLER



20

u./cajita
u./box
u./boîte

15,3 x 8 x 2,8 cm · 0,37 kg

25 boxes · 9,26 kg

CPM620



8414034006204

rendelési kód: F41163020

3

nata®

Mod. 620

5,6 x 1,9 x 1,2 cm

8414034606206>



PG. 33



24

u./cajita
u./box
u./boîte

11 x 8 x 3,1 cm · 0,38 kg

25 boxes · 9,83 kg

CPM624



8414034006242

EGYESÉVEL CSOMAGOLT
INDIVIDUALLY WRAPPED
EMBALLÉES INDIVIDUELLEMENT

rendelési kód: F41157024

3

nata®

Mod. 624

3,9 x 2,7 x 0,9 cm

8414034606244>



PG. 32

PG. 33

TOP
SELLER



RADÍROK · ERASERS · GOMMES À EFFACER



EGYESÉVEL CSOMAGOLT
INDIVIDUALLY WRAPPED
EMBALLÉES INDIVIDUELLEMENT

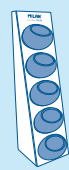

EXPOSITORES
DISPLAYS
PRÉSENTOIR
PG. 262 >

3

rendelési kód: F41162020

nata®

Mod. 6020

6,1 x 2,1 x 1,1 cm

8414034660208>



rendelési kód: MIL000832



20 u./cajita
u./box
u./boîte

12,6 x 11,6 x 2,6 cm · 0,47 kg

25 boxes · 12,15 kg

CPM6020



8414034060206

5 u./cajita
u./box
u./boîte

12 x 6,5 x 1,4 cm · 126 gr

24 boxes · 3,10 kg

CPM6020-05



8414034060213



EGYESÉVEL CSOMAGOLT
INDIVIDUALLY WRAPPED
EMBALLÉES INDIVIDUELLEMENT

3

rendelési kód: F41162024

nata®

Mod. 6024

5 x 2,3 x 0,9 cm

8414034660246>



PG. 33



rendelési kód: MIL000838



24 u./cajita
u./box
u./boîte

10,5 x 10,4 x 3,2 cm · 0,44 kg

25 boxes · 11,40 kg

CPM6024



8414034060244

10 u./cajita
u./box
u./boîte

11,8 x 6,3 x 1,5 cm · 186 gr

24 boxes · 4,50 kg

CPM6024-10



8414034060268



EGYESÉVEL CSOMAGOLT
INDIVIDUALLY WRAPPED
EMBALLÉES INDIVIDUELLEMENT

3

rendelési kód: F41184D30

nata®

Mod. 7030

3,9 x 2,4 x 1 cm

8414034670306>



30 u./cajita
u./box
u./boîte

13,2 x 8,2 x 4 cm · 0,42 kg

25 boxes · 10,75 kg

CPM7030CF



8414034070304



EGYESÉVEL CSOMAGOLT
INDIVIDUALLY WRAPPED
EMBALLÉES INDIVIDUELLEMENT

3

rendelési kód: F41184024

nata®

Mod. 7024

5 x 2,3 x 1 cm

8414034670245>



24 u./cajita
u./box
u./boîte

10,5 x 10,5 x 3,3 cm · 0,43 kg

25 boxes · 10,03 kg

CPM7024CF



8414034070243

RADÍROK · ERASERS · GOMMES À EFFACER



24

u./cajita
u./box
u./boîte

10,5 x 10,5 x 3,3 cm · 0,43 kg

25 boxes · 10,90 kg

CPM7024B



8414034070250

EGYESÉVEL CSOMAGOLT
INDIVIDUALLY WRAPPED
EMBALLÉES INDIVIDUELLEMENT

3

rendelési kód: F41154024

nata®

Mod. 7024 B

5 x 2,3 x 1 cm

8414034670252>



30

u./cajita
u./box
u./boîte

9 x 9 x 8 cm · 0,38 kg

4 boxes · 1,65 kg

CPMF30



8414034000318

rendelési kód: F41182F30

4

CRISTAL
CRISTAL

Mod. F30

4,5 x 1,9 x 1,8 cm

8414034600303>



30

u./cajita
u./box
u./boîte

10,6 x 8,3 x 3,5 cm · 0,40 kg

25 boxes · 10,20 kg

CPM630



8414034006303

EGYESÉVEL CSOMAGOLT
INDIVIDUALLY WRAPPED
EMBALLÉES INDIVIDUELLEMENT

3

rendelési kód: F41172030

nata®

Mod. 630

3,9 x 1,9 x 0,9 cm

8414034606305>

TOP
SELLER



48

u./cajita
u./box
u./boîte

13 x 8 x 3 cm · 0,43 kg

25 boxes · 11,40 kg

CPM648N



8414034006488

rendelési kód: F41171048

3

nata®

Mod. 648

3,1 x 1,9 x 0,9 cm

8414034606480>



PG. 32

TOP
SELLER



RADÍROK · ERASERS · GOMMES À EFFACER



rendelési kód: F41164030

2



FLEXIBILIS SZINTETIKUS RADÍR
FLEXIBLE SYNTHETIC RUBBER

Mod. 6030

5,6 x 1,5 x 1,2 cm

8414034660307>



30

u./cajita
u./box
u./boîte

15,2 x 8 x 2,8 cm · 0,38 kg

25 boxes · 9,90 kg

CPM6030



8414034060305



rendelési kód: F41152030

3

EGYESÉVEL CSOMAGOLT
INDIVIDUALLY WRAPPED
EMBALLÉES INDIVIDUELLEMENT

nata®

Mod. 730

3,9 x 2,4 x 1 cm

8414034602376>



30

u./cajita
u./box
u./boîte

13,1 x 8 x 3,5 cm · 0,43 kg

5 boxes · 11,30 kg

CPM730



8414034009250



rendelési kód: MIL000016

8

MASZATOLÓ

GUMI RADÍR
RUBBER

Mod. 740

5,2 x 1,9 x 0,7 cm

8414034607401>



40

u./cajita
u./box
u./boîte

10,5 x 10,4 x 3,2 cm · 0,53 kg

25 boxes · 13,75 kg

CCM740G



8414034007409



rendelési kód: F41180030

7

MASZATOLÓ

KÉTFELHASZNÁLÁSÚ RADÍR
RUBBER, DOUBLE USE

Mod. 8030

6 x 1,4 x 0,7 cm

30

u./cajita
u./box
u./boîte

14,8 x 6,3 x 2,5 cm · 0,32 kg

25 boxes · 8,10 kg

CCM8030BG



8414034080303



RADÍROK · ERASERS · GOMMES À EFFACER



6

u./cajita
u./box
u./boîte

8 x 7,5 x 2,5 cm · 0,15 kg

30 boxes · 4,72 kg

CCM806BA



8414034008062

rendelési kód: MIL000012

7

KÉTFELHASZNÁLÁSÚ RADÍR
RUBBER, DOUBLE USE

Mod. 806

7,2 x 2,4 x 1 cm

8414034608064>

MASZATOLÓ



40

u./cajita
u./box
u./boîte

10,5 x 10,4 x 3,2 cm · 0,44 kg

25 boxes · 11,50 kg

CCM840RA



8414034008406

rendelési kód: F41180040

7

KÉTFELHASZNÁLÁSÚ RADÍR
RUBBER, DOUBLE USE

Mod. 840

5,2 x 1,9 x 0,8 cm

8414034608408>

MASZATOLÓ



60

u./cajita
u./box
u./boîte

15,3 x 9,4 x 2,6 cm · 0,45 kg

25 boxes · 11,60 kg

CCM860RA



8414034008413

rendelési kód: F41180060

7

KÉTFELHASZNÁLÁSÚ RADÍR
RUBBER, DOUBLE USE

Mod. 860

4,7 x 1,4 x 0,7 cm

8414034608606>

MASZATOLÓ

TOP
SELLER



20

u./cajita
u./box
u./boîte

12,1 x 6,9 x 3,5 cm · 0,37 kg

25 boxes · 9,60 kg

CCM8020



8414034080204

rendelési kód: F41180020

7

KÉTFELHASZNÁLÁSÚ RADÍR
RUBBER, DOUBLE USE

Mod. 8020

6,3 x 2,4 x 0,9 cm



PG. 33

8414034680206>

MASZATOLÓ



RADÍROK · ERASERS · GOMMES À EFFACER



rendelési kód: F41183036

3



**TOP
SELLER**

nata®

Mod. 2036

3,9 x 2,9 x 0,9 cm

8414034620363>



36

u./cajita
u./box
u./boîte

12,7 x 12,4 x 2,9 cm · 0,57 kg

25 boxes · 14,80 kg

CPM2036



8414034020361



rendelési kód: F41154016

EGYESÉVEL CSOMAGOLT
INDIVIDUALLY WRAPPED
EMBALLÉES INDIVIDUELLEMENT

2



**SPECIAL
series**

FLEXIBILIS SZINTETIKUS RADÍR
FLEXIBLE SYNTHETIC RUBBER

Mod. 1416

6,4 x 4 x 0,9 cm

8414034614171>



16

u./cajita
u./box
u./boîte

9 x 9 x 8 cm · 0,46 kg

4 boxes · 1,98 kg

CNM1416STM



84140434014186



rendelési kód: F41190026

2

EGYESÉVEL CSOMAGOLT
INDIVIDUALLY WRAPPED
EMBALLÉES INDIVIDUELLEMENT



**SPECIAL
series**

FLEXIBILIS SZINTETIKUS RADÍR
FLEXIBLE SYNTHETIC RUBBER

Mod. D-4740

ø 4,7 x 0,8 cm

8414034647261>



26

u./cajita
u./box
u./boîte

10 x 9,9 x 9,2 cm · 0,48 kg

9 boxes · 4,52 kg

CNMD4726UC



8414034047269

rendelési kód: MIL000018



2

EGYESÉVEL CSOMAGOLT
INDIVIDUALLY WRAPPED
EMBALLÉES INDIVIDUELLEMENT

FLEXIBILIS SZINTETIKUS RADÍR
FLEXIBLE SYNTHETIC RUBBER

Mod. 4806

14 x 4,4 x 0,9 cm

8414034648060>



6

u./cajita
u./box
u./boîte

14 x 9,3 x 3 cm · 0,51 kg

20 boxes · 10,40 kg

CNM4806



8414034048068

ELEKTROMOS RADÍR · ELECTRIC ERASER · EFFACEUR ÉLECTRIQUE



NÉZD MEG A VIDEÓT!



ART

electric ERASER 16 x 3,7 cm

x12

MASZATOLÓ



14 x 7 x 0,5cm · 10 gr

50 units · 0,57 kg

LPM10060



rendelési kód: MIL000839

x12

MASZATOLÓ



14 x 6 x 0,5cm · 12 gr

50 units · 0,64 kg

LPM10059



rendelési kód: F41196012

rendelési kód: F41195000



rendelési kód: F41195550



2 ELEMMEL ÉS 11 PÓTRADÍRRAL
2 BATTERIES AND 11 SPARE ERASERS INCLUDED
2 PILES ET 11 GOMMES DE RECHANGE INCLUSES

7 NORMÁL

4 MASZATOLÓ

18,5 x 5 x 2,5cm · 89 gr

10 units · 0,98 kg

80 units · 8,20 kg

30767B



8411574078661

30767Y



8411574078678

ADAGOLÓS CERUZARADÍR · AUTOMATIC ERASER HOLDER · PORTE-GOMME AUTOMATIQUE



NÉZD MEG A VIDEÓT!



rendelési kód: F41197034

TRI JET 12,5 x 6,5 x 6,5 cm



x5

NEW DESIGN!

4,5 x 17,5 x 0,7 cm · 30,5 gr

15 units · 0,47kg

225 units · 7,9 kg

30260505



rendelési kód: F41198015



x2

VEGYES SZÍNEK

21 x 6,5 x 2,5 cm · 34 gr

25 units · 1,00 kg

BYM10174



rendelési kód: F41197BL3



21 u./cajita
u./box
u./bőite

12,5 x 6,5 x 6,5 cm · 0,31 kg

6 displays · 2,00 kg

3026521



8411574032199



TOP SELLER



rendelési kód: F41197024

JET ERASER 12,4 cm x Ø 0,8 cm



x5

NEW DESIGN!

4,5 x 17,5 x 0,7 cm · 21,6 gr

15 units · 0,41 kg

225 units · 7 kg

81517



rendelési kód: F41198005



x2

VEGYES SZÍNEK

21 x 6,5 x 1,7 cm · 49 gr

25 units · 1,20 kg

BPM9260



rendelési kód: MIL000580



24 u./cajita
u./box
u./bőite

12,8 x 6,7 x 6,7 cm · 0,32 kg

6 units · 2,10 kg

3026324



8411574011965



BLISZTERES TERMÉKEK · BLISTER PACKS · BLISTERS

Bliszteres termékeink esetén a feltüntetett legkisebb rendelési egység (units) megegyezik a minimum rendelési egységgel!

| | | | | |
|---|---|---|--|--|
|  <p>3</p> <p>1</p> |  <p>1</p> <p>3</p> |  <p>1</p> <p>1</p> |  <p>1</p> |  <p>2</p> |
| <p>21 x 6,5 x 1,5 cm · 68 gr</p> <p>25 units · 1,86 kg</p> | <p>21 x 6,5 x 1,5 cm · 72 gr</p> <p>25 units · 1,95 kg</p> | <p>21 x 6,5 x 1,5 cm · 74 gr</p> <p>25 units · 2 kg</p> | <p>21 x 6,5 x 1,3 cm · 72 gr</p> <p>25 units · 1,95 kg</p> | <p>21 x 6,5 x 1,5 cm · 82 gr</p> <p>25 units · 2,20 kg</p> |
| <p>BVM10048</p>  <p>8414034950019</p> | <p>BVM10046</p>  <p>8414034950026</p> | <p>BMM97011</p>  <p>8414034970116</p> | <p>BMM10045</p>  <p>8414034900038</p> | <p>BMM9202</p>  <p>8414034964368</p> |

| | | | |
|--|---|---|--|
|  <p>1</p> |  <p>1</p> |  <p>1</p> |  <p>1</p> |
| <p>14 x 8,2 x 1,5 cm · 52 gr</p> <p>25 units · 1,47 kg</p> | <p>14 x 8,2 x 1,5 cm · 72 gr</p> <p>25 units · 1,95 kg</p> | <p>14 x 8,2 x 1,5 cm · 42 gr</p> <p>25 units · 1,20 kg</p> | <p>14 x 8,2 x 1,5cm · 80 gr</p> <p>25 units · 2,15 kg</p> |
| <p>BMM9358</p>  <p>8414034942823</p> | <p>BMM10049</p>  <p>8414034944568</p> | <p>BMM9203</p>  <p>8414034931247</p> | <p>BMM9221</p>  <p>8414034934200</p> |

| | | | |
|--|---|---|--|
|  <p>1</p> |  <p>1</p> |  <p>1</p> <p>2</p> |  <p>1</p> |
| <p>14 x 8,2 x 1,5 cm · 72 gr</p> <p>25 units · 1,95 kg</p> | <p>14 x 8,2 x 2 cm · 54 gr</p> <p>25 units · 1,45 kg</p> | <p>14 x 8,2 x 1,5 cm · 60 gr</p> <p>25 units · 1,65 kg</p> | <p>14 x 8,2 x 1,5cm · 83 gr</p> <p>25 units · 2,22 kg</p> |
| <p>BMM9215</p>  <p>8414034043049</p> | <p>BMM10407</p>  <p>8414034900595</p> | <p>BMM9222</p>  <p>8414034954451</p> | <p>BMM9218</p>  <p>8414034940188</p> |

BLISZTERES TERMÉKEK · BLISTER PACKS · BLISTERS

Bliszteres termékeink esetén a feltüntetett legkisebb rendelési egység (units) megegyezik a minimum rendelési egységgel!



1

14 x 8,2 x 1,5cm · 63 gr

25 units · 1,71 kg

BMM9232



8414034940201



1

14 x 8,2 x 1,5cm · 80 gr

25 units · 2,15 kg

BMM10442



8414034029579



3

14 x 8,2 x 1,5 cm · 59 gr

25 units · 1,65 kg

BPM10452



8414034029586



3

14 x 8,2 x 1,5 cm · 59 gr

25 units · 1,65 kg

BPM10484



8414034029593



3

14 x 8,2 x 1,5cm · 33 gr

25 units · 1,03 kg

BPM9243



8414034926021



3

14 x 8,2 x 1,5cm · 58 gr

25 units · 1,65 kg

BPM10042



8414034932022



3

14 x 8,2 x 1,5cm · 57 gr

25 units · 1,55 kg

BPM10043



8414034952020



3

14 x 8,2 x 1,5cm · 52 gr

25 units · 1,45 kg

BPM9205



8414034936242



3

14 x 8,2 x 1,5cm · 66 gr

25 units · 1,80 kg

BPM10054



8414034946241



3

14 x 8,2 x 1,5cm · 61 gr

25 units · 1,67 kg

BPM9208



8414034026127



3

14 x 8,2 x 1,5cm · 42 gr

25 units · 1,15 kg

BPM10044



8414034962029



7

1

14 x 8,2 x 1,5cm · 48 gr

25 units · 1,33 kg

BVM9216



8414034900014



CAPSULE



PEACOCK



STICK



COMPACT



extension



sphere



duo



SLIDE



BE ATOMIC



FAIRY TALE



collection



AFILA 1918



Juicy

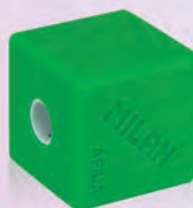

CUBIC



spin NEW LOOK



CAPSULE COPPER



MILAN®

HEGYZŐ+RADÍROK ERASERS WITH SHARPENER AND PENCIL SHARPENERS GOMMES AVEC TAILLE-CRAYONS ET TAILLE-CRAYONS

BIZTONSÁGOS RENDSZER, AMELY MEGGÁTOLJA A PENGÉ ELTÁVOLÍTÁSÁT A HEGYZŐ TESTÉBŐL.



SAFETY SYSTEM WHICH PREVENTS THE BLADE FROM SEPARATING FROM THE BODY OF THE SHARPENER.

SYSTÈME DE SÉCURITÉ QUI EMPÊCHE LA SÉPARATION DE LA LAME DU CORPS DU TAILLE-CRAYONS.



ÉLES, ELLENÁLLÓ SZÉNACÉL PENGÉVEL ELLÁTVA.

SHARP, RESISTANT CARBON STEEL BLADE.

LAME EN ACIER AU CARBONE, AIGUISÉE ET RÉSISTANTE.



1 LYUKŰ HEGYZŐ.

STANDARD SHARPENER.
TAILLE-CRAYONS SIMPLE.



2 LYUKŰ HEGYZŐ (NORMÁL ÉS MAXI)

DOUBLE SHARPENER: STANDARD AND MAXI.
TAILLE-CRAYONS DOUBLE: SIMPLE ET MAXI.

A hegyező+radírok a MILAN R+D osztálya által tervezett innovatív termékek, amelyek a Milan radírokat egyesítik tartályos hegyezőkkel. Különböző mintákkal, sokféle forma- és színkivitelben.

A MILAN hegyezők széles választékát kínálja rengeteg méretben, tartályos és tartály nélküli kivitelben, egytől egyig a MILAN R+D osztály által tervezve.

These erasers with pencil sharpeners are an innovative product developed by the R&D department that combines a MILAN eraser with a pencil sharpener with a receptacle. Different design lines, series and colours available.

MILAN pencil sharpeners, with or without a receptacle, are available in different colours and sizes for all types of pencils and have a sharp and resistant safety blade. They are designed by the R&D department

Les gommes avec taille-crayon sont un produit innovateur développé par le département R+D combinant une gomme MILAN et un taille-crayon avec réservoir. Différentes conceptions, séries et couleurs disponibles.

Les taille-crayons MILAN avec ou sans réservoir sont disponibles en plusieurs couleurs et formats pour tous les types de crayons et sont dotés d'une lame de sécurité aiguisée et résistante. Sont conçus par le département R+D.

HEGYZŐ+RADÍROK · ERASERS WITH SHARPENER · GOMMES AVEC TAILLE-CRAYONS

rendelési kód: F42181T01



CAPSULE PATENTED DESIGN 6,5 x 3,5 x 2,4 cm · 26,7 gr



16 unidades/cajita
units/box
unités/boîte

15 x 10,5 x 7 cm · 0,48 kg

10 units · 5,20 kg

20 units · 10,90 kg

4701116

8411574023883



x2

17 x 8,2 x 2,8 cm · 60 gr

12 units · 0,90 kg

BYM10034

rendelési kód: F42181BL1



14 x 8,2 x 2,7 cm · 34 gr

20 units · 10,90 kg

BYM10008

rendelési kód: MIL000790

rendelési kód: F42180T01



CAPSULE PATENTED DESIGN 6,5 x 3,5 x 2,4 cm · 26,7 gr

FELCSERELHETŐ SZÍNEK
INTERCHANGEABLE COLOURS
COULEURS INTERCHANGEABLES



24 unidades/cajita
units/box
unités/boîte

11,7 x 11,7 x 11,5 cm · 0,72 kg

6 units · 4,60 kg

12 units · 9,41 kg

4709624

8411574092971



CAPSULE PATENTED DESIGN 6,5 x 3,5 x 2,4 cm · 26,7 gr

PEACOCK

SPECIAL series

x2

17 x 8,2 x 2,8 cm · 60 gr

12 units · 0,90 kg

BYM10034PCK

8411574095996



rendelési kód: MIL000793

x3

14 x 8,2 x 1,5 cm · 44 gr

12 units · 0,55 kg

BNM10258

8411574038252



rendelési kód: F41185001

HEGYEZŐ+RADÍROK · ERASERS WITH SHARPENER · GOMMES AVEC TAILLE-CRAYONS

rendelési kód: F42182R01

NEW!



16 unidades/cajita
units/box
unités/boîte

15 x 10,5 x 7 cm · 0,48 kg

10 units · 5,20 kg

20 units · 10,90 kg

SPECIAL series



4701116RL



8411574106296

ROLLER

CAPSULE

PATENTED DESIGN

6,5 x 3,5 x 2,4 cm · 26,7 gr



x2



rendelési kód: MIL000794

VEGYES SZÍNEK

17 x 8,2 x 2,8 cm · 60 gr

12 units · 0,90 kg

BYM10034RL



8411574106524



ROLLER COLLECTION
PG. 256



16 unidades/cajita
units/box
unités/boîte

15 x 10,5 x 7 cm · 0,48 kg

10 units · 5,20 kg

20 units · 10,90 kg

VEGYES SZÍNEK



rendelési kód: MIL000791

14 x 8,2 x 2,7 cm · 34 gr

12 units · 0,46 kg

BYM10008FR



8411574101000

TOP SELLER

rendelési kód: F42182F01



Fairy TALE

SPECIAL series



CAPSULE

PATENTED DESIGN

6,5 x 3,5 x 2,4 cm · 26,7 gr



HEGYZŐ+RADÍROK · ERASERS WITH SHARPENER · GOMMES AVEC TAILLE-CRAYONS

NEW LOOK SERIES

rendelési kód: F42182L01

CAPSULE PATENTED DESIGN 6,5 x 3,5 x 2,4 cm · 26,7 gr

STANDARD SHARPENER

rendelési kód: MIL000819

VEGYES SZÍNEK

16 unidades/cajita
units/box
unités/boîte

15 x 10,5 x 7 cm · 0,48 kg

10 units · 5,20 kg

20 units · 10,90 kg

4701116LK2

8411574093749

14 x 8,2 x 2,7 cm · 34 gr

12 units · 0,46 kg

144 units · 6,6 kg

BYM10400LK2

8411574095798

rendelési kód: F42181910

SILVER SERIES

CAPSULE PATENTED DESIGN 6,5 x 3,5 x 2,4 cm · 26,7 gr

STANDARD SHARPENER

x2

rendelési kód: MIL000814

VEGYES SZÍNEK

12 unidades/cajita
units/box
unités/boîte

15 x 8 x 6,8 cm · 0,35 kg

12 units · 4,70 kg

24 units · 9,90 kg

4714112

8411574060499

17 x 8,2 x 2,8 cm · 60 gr

12 units · 0,90 kg

BYM10356

8411574065470

rendelési kód: F42181C01

COPPER SERIES

CAPSULE PATENTED DESIGN 6,5 x 3,5 x 2,4 cm · 26,7 gr

STANDARD SHARPENER

12 unidades/cajita
units/box
unités/boîte

15 x 8 x 6,8 cm · 0,35 kg

12 units · 4,70 kg

24 units · 9,90 kg

4717112

8411574071631

14 x 8,2 x 2,7 cm · 34 gr

12 units · 0,46 kg

BYM10378

rendelési kód: MIL000817

BYM10379

rendelési kód: MIL000818

HEGYEZŐ+RADÍROK · ERASERS WITH SHARPENER · GOMMES AVEC TAILLE-CRAYONS

1918
SERIES

TOP
SELLER

rendelési kód: F42191C02



COMPACT PATENTED DESIGN 6,7 x 4 x 2,5 cm · 40,4 gr



16 unidades/cajita
units/box
unités/boîte

17 x 11 x 7 cm · 0,68 kg

8 units · 5,70 kg

16 units · 11,80 kg

4703116SNC

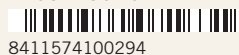

8411574100294

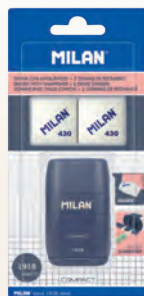

x2 MILAN 430

17 x 8,2 x 2,8 cm · 86 gr

12 units · 1,07 kg

BYM10140SNCB

rendelési kód: MIL000799

BYM10140SNCP

rendelési kód: MIL000800



rendelési kód: MIL000796

VEGYES SZÍNEK

10 x 8,2 x 2,8 cm · 46 gr

12 units · 0,67 kg

BYM10139SNC



8411574103714

16 unidades/cajita
units/box
unités/boîte

17 x 11 x 7 cm · 0,68 kg

8 units · 5,70 kg

16 units · 11,80 kg

4721116

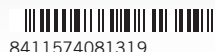

8411574081319

TOP
SELLER

SUNSET
SERIES



rendelési kód: F42191S02

COMPACT PATENTED DESIGN 6,7 x 4 x 2,5 cm · 40,4 gr



x2 MILAN 430



17 x 8,2 x 2,8 cm · 86 gr

12 units · 1,07 kg

BYM10451

rendelési kód: MIL000823

BYM10454

rendelési kód: MIL000824



14 x 8,2 x 2,8 cm · 46 gr

12 units · 0,67 kg

BYM10423

rendelési kód: MIL000821

BYM10424

rendelési kód: MIL000822



12 x 4,2 x 2,8 cm · 50 gr

12 units · 0,63 kg

144 units · 7,90 kg

BYM10473PR



rendelési kód: MIL000827

HEGYEZŐ+RADÍROK · ERASERS WITH SHARPENER · GOMMES AVEC TAILLE-CRAYONS

rendelési kód: F42191T02

TOP
SELLER



NÉZD MEG A
VIDEÓT



COMPACT PATENTED DESIGN

6,7 x 4 x 2,5 cm · 40,4 gr



16 unidades/cajita
units/box
unités/boîte

17 x 11 x 7 cm · 0,68 kg

8 units · 5,70 kg

16 units · 11,80 kg

4703116

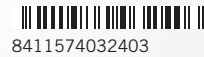

8411574032403

x2



rendelési kód: M1L000797

VEGYES SZÍNEK



rendelési kód: M1L000795

17 x 8,2 x 2,8 cm · 86 gr

12 units · 1,07 kg

BYM10140

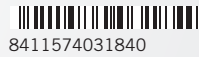

8411574031840

14 x 8,2 x 2,8 cm · 46 gr

12 units · 0,62 kg

BYM10139



8411574031833



rendelési kód: F42191TOU

DUO



COMPACT PATENTED DESIGN

6,7 x 4 x 2,5 cm · 40,4 gr



16 unidades/cajita
units/box
unités/boîte

17 x 11 x 7 cm · 0,68 kg

8 units · 5,70 kg

16 units · 11,80 kg

4706116

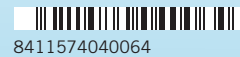

8411574040064

x2



rendelési kód: X00005709

VEGYES SZÍNEK

17 x 8,2 x 2,8 cm · 86 gr

12 units · 1,07 kg

BYM10272

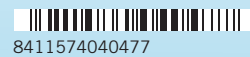

8411574040477

rendelési kód: F42191MIX



FELCSERELHETŐ SZÍNEK
INTERCHANGEABLE COLOURS
COULEURS INTERCHANGEABLES

MIX
SERIES



COMPACT PATENTED DESIGN

6,7 x 4 x 2,5 cm · 40,4 gr



24 unidades/cajita
units/box
unités/boîte

12,9 x 12,9 x 12,7 cm · 1,09 kg

6 units · 6,80 kg

12 units · 14 kg

4710624

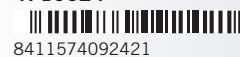

8411574092421

x2



rendelési kód: M1L000808

VEGYES SZÍNEK

17 x 8,2 x 2,8 cm · 86 gr

12 units · 1,07 kg

BYM10315

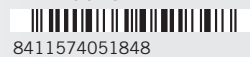

8411574051848

HEGYEZŐ+RADÍROK · ERASERS WITH SHARPENER · GOMMES AVEC TAILLE-CRAYONS

rendelési kód: F42190S02



16

u./cajita
u./box
u./boîte

17 x 11 x 7 cm · 0,68 kg

8 units · 5,70 kg

16 units · 11,80 kg

4703116DW



8411574106487



x2



rendelési kód: MIL000798

17 x 8,2 x 2,8 cm · 86 gr

12 units · 1,07 kg

BYM10140DW



8411574106579



COMPACT PATENTED DESIGN 6,7 x 4 x 2,5 cm · 40,4 gr



NEW!

rendelési kód: MIL000539



x4 PÓTRADÍR
SPARE ERASERS
GOMMES DE RECHANGE

14 x 8,2 x 1,5 cm · 72 gr

25 units · 1,95 kg

BMM9215



8414034043049



SHADOW
SERIES
PG. 170/178

rendelési kód: F42190V02



16

unidades/cajita
units/box
unités/boîte

17 x 11 x 7 cm · 0,68 kg

8 units · 5,70 kg

16 units · 11,80 kg

4703116VK



8411574103882



COMPACT PATENTED DESIGN 6,7 x 4 x 2,5 cm · 40,4 gr



HEGYEZŐ+RADÍROK · ERASERS WITH SHARPENER · GOMMES AVEC TAILLE-CRAYONS

rendelési kód: F42185T01

zaci
SERIES

MILAN®
Spain
MILAN®
TRI

TRI PATENTED DESIGN 6,1 x 3,2 x 3 cm · 30,4 gr

STANDARD SHARPENER

x3 PÓTRADÍR
SPARE ERASERS
GOMMES DE RECHANGE

rendelési kód: F41185002

MILAN®
Spain
GOMMES DE RECHANGE
PÓTRADÍR
SPARE ERASERS
x3
GOMMES DE RECHANGE
PÓTRADÍR
SPARE ERASERS

16 unidades/cajita
units/box
unités/boîte

13,2 x 12 x 6,5 cm · 0,5 kg

10 units · 5,30 kg

20 units · 11,10 kg

4700116

8411574032410

14 x 8,2 x 2,5cm · 43 gr

12 units · 0,60 kg

BNM10257

8411574038245

rendelési kód: F42187T01

MILAN
Spain
MILAN
bubble

bubble PATENTED DESIGN Ø 6,5 x 2,2 cm · 31,7 gr

STANDARD SHARPENER

MILAN
Spain
16 unidades/cajita
units/box
unités/boîte

19 x 15 x 6,5 cm · 0,59 kg

3 units · 1,86 kg

18 units · 12 kg

4704116

8411574038542

rendelési kód: F42179SWP

PASTEL
SERIES

MILAN®
Spain
MILAN®
PASTEL

sway PATENTED DESIGN 6,1 cm x Ø 3 cm · 18,4 gr

STANDARD SHARPENER

MILAN
Spain
12 unidades/cajita
units/box
unités/boîte

13 x 9,5 x 6 cm · 0,27 kg

10 units · 2,86 kg

40 units · 6 kg

4723112

8411574082699

HEGYEZŐ+RADÍROK · ERASERS WITH SHARPENER · GOMMES AVEC TAILLE-CRAYONS



16 unidades/cajita
units/box
unités/boîte

12,5 x 12,5 x 6 cm · 0,43 kg

10 units · 4,55 kg

20 units · 9 kg

4725116FN

8411574101642

THE FUN SERIES

BŐVÍTHETŐ TARTÁLY
EXTENDIBLE DEPOSIT
RÉSERVOIR EXTENSIBLE

rendelési kód: F42194T02

extension **PATENTED DESIGN** 6,6 x 6 x 2,8 cm · 24,3 gr

STANDARD SHARPENER

x2 PÓTRADÍR
SPARE ERASERS
GOMMES DE REMPLACEMENT

rendelési kód: MIL000556

14 x 6 x 1,7 cm · 32 gr

12 units · 0,35 kg

96 units · 3 kg

BNM10486

8411574099277



16 unidades/cajita
units/box
unités/boîte

12,5 x 12,5 x 6 cm · 0,43 kg

10 units · 4,55 kg

20 units · 9 kg

4725116NJ

8411574101147

NINJUTSU

BŐVÍTHETŐ TARTÁLY
EXTENDIBLE DEPOSIT
RÉSERVOIR EXTENSIBLE

rendelési kód: F42201T02

SPECIAL series

extension **PATENTED DESIGN** 6,6 x 6 x 2,8 cm · 24,3 gr

STANDARD SHARPENER

16 unidades/cajita
units/box
unités/boîte

12,5 x 12,5 x 6 cm · 0,43 kg

10 units · 4,55 kg

20 units · 9,45 kg

4725116SM

8411574095750



14 x 8,2 x 2,8 cm · 37 gr

12 units · 4,44 kg

BYM10471SM

8411574096016

BŐVÍTHETŐ TARTÁLY
EXTENDIBLE DEPOSIT
RÉSERVOIR EXTENSIBLE

rendelési kód: F42199T02

SPECIAL series

swims

extension **PATENTED DESIGN** 6,6 x 6 x 2,8 cm · 24,3 gr

STANDARD SHARPENER

HEGYZŐ+RADÍROK · ERASERS WITH SHARPENER · GOMMES AVEC TAILLE-CRAYONS



HEGYZŐVEL SHARPENER

STICK PATENTED DESIGN 6,1 cm x Ø 3 cm · 18,4 gr



rendelési kód: F42189T01



16 unidades/cajita
units/box
unités/boîte

9 x 8,5 x 8 cm · 0,41 kg

10 units · 4,20 kg

20 units · 8,80 kg

4702116

8411574032342

rendelési kód: F41185005



x3 PÓTRADÍR
SPARE ERASERS
GOMMES DE RECHANGE

14 x 8,2 x 1,6 cm · 25 gr

12 units · 0,34 kg

BNM10236

8411574036364



SERIES

HEGYZŐVEL SHARPENER

STICK PATENTED DESIGN 6,1 cm x Ø 3 cm · 18,4 gr



EZÜST-FOSZFÁT ÜVEGGEL KEZELVE (CAS 308069-39-8), ANTIBAKTERIÁLIS HATÁSÚ.

THE ERASER WITH SHARPENER'S BODY INCORPORATES A BIOCIDES. TREATED WITH SILVER PHOSPHATE GLASS (CAS 308069-39-8) WITH ANTIBACTERIAL EFFECT.

LE CORPS DE LA GOMME AVEC TAILLE-CRAYONS INCLUT UN BIOCIDES. TRAITÉ AU VERRE DE PHOSPHATE D'ARGENT (CAS 308069-39-8) AVEC EFFET ANTIBACTÉRIEN.

rendelési kód: MIL000801



14 x 8,2 x 2,2 cm · 30 gr

12 units · 0,41 kg

BYM10141BGGR

8411574093596

rendelési kód: MIL000802



14 x 8,2 x 2,2 cm · 30 gr

12 units · 0,41 kg

BYM10141IBGP

8411574093602

2 LYUKÚ HEGYEZŐK · DOUBLE PENCIL SHARPENERS · TAILLE-CRAYONS DOUBLES



24 unidades/cajita
units/box
unités/boîte

12 x 10 x 9,8 cm · 0,46 kg

12 units · 5,90 kg

20166224SN



8411574084235



TARTÁLYAL
WITH DEPOSIT
AVEC RÉSERVOIR

rendelési kód: F42192S02

SUNSET
SERIES

TOP
SELLER



COMPACT PATENTED DESIGN 4,8 x 3,9 x 2,5 cm · 12 gr



18 unidades/cajita
units/box
unités/boîte

14 x 11 x 4,4 cm · 0,26 kg

10 units · 2,75 kg

40 units · 11,40 kg

20152918



8411574025627



TARTÁLYAL
WITH DEPOSIT
AVEC RÉSERVOIR

rendelési kód: F42195T02

normál

ZICZ
SERIES

MAXI



DOUBLE PATENTED DESIGN 4,8 x 3,9 x 2,5 cm · 12 gr



12 unidades/cajita
units/box
unités/boîte

19 x 13,5 x 4,5 cm · 0,35 kg

7 units · 2,60 kg

28 units · 10,90 kg

20162212



8411574037736



NAGY BŐVÍTHETŐ TARTÁLYAL
WITH LARGE DEPOSIT EXTENSIBLE AVEC
UN GRAND RÉSERVOIR EXTENSIBLE

rendelési kód: F42197T02



extensiön PATENTED DESIGN Ø 4,5 x 4 cm · 25 gr



2 LYUKÚ HEGYEZŐK · DOUBLE PENCIL SHARPENERS · TAILLE-CRAYONS DOUBLES

FLUO
SERIES

TARTÁLYVAL
WITH DEPOSIT
AVEC RÉSERVOIR

sphere **PATENTED DESIGN** Ø 4,4 x 4,2 cm · 18 gr

rendelési kód: F42193T02

24 unidades/cajita
units/box
unités/boîte

12,9 x 12,9 x 12,7 cm · 0,55 kg

6 units · 3,56 kg

12 units · 7,44 kg

20156824FL

8411574092414

rendelési kód: F42196T02

look
SERIES

duET **PATENTED DESIGN** 4 x Ø 3,8 cm · 20 gr

x2

NAGY TARTÁLY
LARGE DEPOSIT
GRAND RÉSERVOIR

12 unidades/cajita
units/box
unités/boîte

12 x 8,4 x 8 cm · 0,28 kg

6 units · 1,80 kg

36 units · 11,50 kg

20155212

8411574030683

+
SERIES

collection **PATENTED DESIGN** 5,1 x Ø 3,7 cm · 21 gr

A HEGYEZŐ TESTE BIOCIDOT TARTALMAZ. EZÜST-FOSZFÁT ÜVEGGEL KEZELVE (CAS 308069-39-8), ANTIBAKTERIÁLIS HATÁSÚ.

THE DOUBLE SHARPENER BODY INCORPORATES A BIOCID. TREATED WITH SILVER PHOSPHATE GLASS (CAS 308069-39-8) WITH ANTIBACTERIAL EFFECT.

LE CORPS DU TAILLE-CRAYONS DOUBLE INCLUT UN BIOCID. TRAITÉ AU VERRE DE PHOSPHATE D'ARGENT (CAS 308069-39-8) AVEC EFFET ANTIBACTÉRIEN.

NAGY TARTÁLY
LARGE DEPOSIT
GRAND RÉSERVOIR

BWM10448IBGGR

rendelési kód: MIL000734

2 LYUKÚ HEGYEZŐK · DOUBLE PENCIL SHARPENERS · TAILLE-CRAYONS DOUBLES



x4 MILAN 430

rendelési kód: MIL000820

VEGYES SZÍNEK

12 unidades/cajita
units/box
unités/boîte

16,5 x 12 x 5 cm · 0,30 kg

5 units · 1,65 kg

30 units · 10,40 kg

20161912FR

8411574101635

BYM10410

8411574082019



rendelési kód: F42203T02

NAGY TARTÁLY
LARGE DEPOSIT
GRAND RÉSERVOIR

FAIRY
TALE

SPECIAL
series



collection PATENTED DESIGN 5,1 x Ø 3,7 cm · 21 gr



x4 MILAN 430

rendelési kód: MIL000806

VEGYES SZÍNEK

12 unidades/cajita
units/box
unités/boîte

16,5 x 12 x 5 cm · 0,30 kg

5 units · 1,65 kg

30 units · 10,40 kg

20161912BTM

8411574084280

BYM10273BTM

8411574095767



rendelési kód: F42198B02

SPECIAL
series

BE
ATOMIC

NAGY TARTÁLY
LARGE DEPOSIT
GRAND RÉSERVOIR



collection PATENTED DESIGN 5,1 x Ø 3,7 cm · 21 gr



x4 MILAN 430

rendelési kód: MIL000805

VEGYES SZÍNEK

12 unidades/cajita
units/box
unités/boîte

16,5 x 12 x 5 cm · 0,30 kg

5 units · 1,65 kg

30 units · 10,40 kg

20161912

8411574040088

BYM10273

8411574040484



rendelési kód: F42198T02

NAGY TARTÁLY
LARGE DEPOSIT
GRAND RÉSERVOIR



collection PATENTED DESIGN 5,1 x Ø 3,7 cm · 21 gr



HEGYZŐ KÉTFÉLE HEGYZÉSI MÓDDAL · TWO TYPES OF PENCIL SHARPENERS DEUX TYPES DE TAILLE

rendelési kód: F42192T02



SLIDE PATENTED DESIGN 7 x 2,7 x 2,7 cm · 16 gr



**HEGYES
SHARP TIP
POINTE POINTUE**

**KERÉKÍTETT
ROUND TIP
POINTE RONDE**



HEGYES

KÉTFÉLE HEGYZÉSI MÓD
TWO TYPES OF SHARPEN
DEUX TYPES DE TAILLE



KERÉKÍTETT



12 unidades/cajita
units/box
unités/boîte

18 x 14,2 x 3 cm · 0,25 kg

10 units · 2,60 kg

40 units · 11 kg

20153212

8411574030584

HEGYZŐK · SHARPENERS · TAILLE-CRAYONS



rendelési kód: F42183JCY

**TARTÁLYAL
WITH DEPOSIT
AVEC RÉSERVOIR**

Juicy PATENTED DESIGN 5 x 4,5 x 2,5 cm · 15 gr



32 unidades/cajita
units/box
unités/boîte

17 x 15,5 x 11,5 cm · 0,60 kg

1 units · 0,67 kg

8 units · 6,00 kg

20164132

8411574053538



rendelési kód: F42182T01

**TARTÁLYAL
WITH DEPOSIT
AVEC RÉSERVOIR**

CUBIC PATENTED DESIGN 2,8 x 2,8 x 2,8 cm · 10 gr



16 unidades/cajita
units/box
unités/boîte

12,5 x 12,5 x 3,1 cm · 0,19 kg

10 units · 1,95 kg

60 units · 12,40 kg

20154216

8411574030591

HEGYZŐK · PENCIL SHARPENERS · TAILLE-CRAYONS



x1 MILAN 1918
TAILLE-CRAYON

rendelési kód: MIL000803

VEGYES SZÍNEK



rendelési kód: F42183T01



NÉZD MEG A VIDEÓT!



1918 SERIES

32 unidades/cajita
units/box
unités/boîte

11,9 x 11,6 x 3 cm · 0,17 kg

60 units · 10,6 kg

20140932

8411574025641

14 x 8,2 x 1,7 cm · 24 gr

25 units · 0,75 kg

BYM10170

8411574034032

AFILA PATENTED DESIGN 2,7 x 2,7 x 1,3 cm · 4,6 gr



x4 MILAN 430

rendelési kód: MIL000804

VEGYES SZÍNEK



TARTÁLYAL
WITH DEPOSIT
AVEC RÉSERVOIR

rendelési kód: F42186T01



NEW LOOK SERIES

24 unidades/cajita
units/box
unités/boîte

11,9 x 11,6 x 3 cm · 0,17 kg

60 units · 10,6 kg

20157924LK2

8411574096979

17 x 8,2 x 3 cm · 84 gr

25 units · 2,5 kg

BYM10227

8411574036234

spin PATENTED DESIGN Ø 4 x 2,1 cm · 10 gr



TARTÁLYAL
WITH DEPOSIT
AVEC RÉSERVOIR



rendelési kód: F42181COP



COPPER SERIES



24 unidades/cajita
units/box
unités/boîte

11 x 10 x 10 cm · 0,34 kg

12 units · 5,10 kg

20165224CP

8411574080893

CAPSULE PATENTED DESIGN 4,9 x 3,5 x 2,5 cm · 13 gr



HEGYZŐK · PENCIL SHARPENERS · TAILLE-CRAYONS



rendelési kód: F42176060

**TOP
SELLER**

SQUARE PATENTED DESIGN 2,5 x 1,6 x 1,1 cm · 3 gr



60 unidades/cajita
units/box
unités/boîte

13 x 10,2 x 2,8 cm · 0,18 kg

40 units · 7,6 kg

20120260



8411574028147



20 unidades/cajita
units/box
unités/boîte

13,5 x 3,3 x 3,3cm · 62 gr

40 units · 2,55 kg

160 units · 10,5 kg

20120320



rendelési kód: MIL000046

ÁTLÁTSZÓ MAXI HEGYZŐ · TRANSPARENT MAXI SHARPENERS TAILLE-CRAYONS MAXI TRANSPARENTS

MAXI



rendelési kód: F42177040

2,5 x 1,8 x 1,4 cm



40 unidades/cajita
units/box
unités/boîte

10,5 x 10 x 2,5 cm · 0,12 kg

10 units · 1,25 kg

80 units · 10,5 kg

20127240



8411574030362

FÉM HEGYZŐK · METAL SHARPENERS · TAILLE-CRAYONS MÉTALLIQUES

rendelési kód: F42173020



2,5 x 1,5 x 1 cm

rendelési kód: F42171020



2,5 x 1,8 x 1/0,5 cm

rendelési kód: F42172020



2,5 x 2,5 x 1,5 cm

normál

MAXI

1 HEGYZŐ
1 DUPLA HEGYZŐ
1 SHARPENER AND
1 DOUBLE SHARPENER
1 TAILLE-CRAYONS ET
1 TAILLE-CRAYONS DOUBLE

**TOP
SELLER**



20

u./cajita
u./box
u./boîte

10,5 x 8 x 1,3 cm · 144 gr

20 units · 3,06 kg

60 units · 9,20 kg

80034



8411574800347

**TOP
SELLER**



NEW
DESIGN!

20

u./cajita
u./box
u./boîte

10,5 x 8 x 1 cm · 100 gr

20 units · 2,05 kg

60 units · 6,40 kg

80033



8411574800330

NEW
DESIGN!



20

u./cajita
units/box
unités/boîte

12,5 x 10,5 x 1,5 cm · 0,19 kg

60 units · 11,5 kg

80035



8411574800354

rendelési kód: MIL000785



14 x 8,2 x 1,6 cm · 28 gr

25 units · 0,83 kg

BWM9079



8411574090793

2 LYUKÚ ELEKTROMOS HEGYEZŐ · DOUBLE ELECTRIC PENCIL SHARPENERS WITH DEPOSIT · TAILLE-CRAYONS ÉLECTRIQUE DOUBLE AVEC RÉSERVOIR

2 PÓTHEGEYZŐ
(1 MAXI, 1 NORMÁL)

2 SPARE SHARPENERS
(1 MAXI, 1 REGULAR)
2 TAILLE-CRAYONS DE
RECHANGE
(1 MAXI, 1 REGULAR)



rendelési kód: MIL000078

8 x 6,8 x 2,2 cm · 5,6 gr

20910702



8411574054856



rendelési kód: F42162000

NÉZD MEG A
VIDEÓT!



1918

SERIES

MAXI

NORMÁL

4 ELEMMELELLÁTVA
4 BATTERIES INCLUDED
4 PILES INCLUSES

23,5 x 11 x 7 cm · 0,22 kg

12 units · 2,9 kg

36 units · 9,60 kg



6,6 x 6,4 x 6,3 cm · 101 gr



ELEKTROMOS HEGYEZŐK · ELECTRIC PENCIL SHARPENERS WITH DEPOSIT · TAILLE-CRAYONS ÉLECTRIQUE AVEC RÉSERVOIR

2 PÓTÉL

2 SPARE SHARPS
2 LAMES DE
RECHANGE



rendelési kód: MIL000077

14 x 7 x 0,3 cm · 3,6 gr

LWM10474



8411574096108



4 ELEMMELELLÁTVA
4 BATTERIES INCLUDED
4 PILES INCLUSES

23,5 x 11 x 6,5 cm · 0,25 kg

12 units · 3,20 kg

36 units · 10,40 kg

BWM10375



rendelési kód: F42161550

BWM10149



rendelési kód: F42161103

NÉZD MEG A
VIDEÓT!



NORMÁL

ACID
SERIES



6,7 x Ø 6,6 cm · 0,21 kg





1 mm

P1 touch

1 mm

P1

1 mm

P1 touch mini

1 mm

P1 touch mini colours

1 mm

P1 touch colours

1 mm

P1

THE FUN SERIES

1 mm

P1

SILVER SERIES

1 mm

P1

+

A MILAN írószerek széles választékát a R&D osztály tervezte, az egyes formákat szabadalom védi. A design, a minőség és a praktikusság azok az értékek, amelyek a legfontosabb irányelvek a MILAN írószer család megtervezésekor. Az írószer kínálat a P1 tollak 2009-es bevezetése óta folyamatosan fejlődik.

NÉMET TINTÁVAL ELLÁTVA

The extensive range of MILAN pens has been designed by the R&D department, registering its own patents. Design, quality and functionality are the values which guide the creation of MILAN pens, a category which has grown since the launch of the P1 family in 2009.

INK MADE IN GERMANY

La large gamme de stylos MILAN a été conçue par le département R&D, qui dépose lui-même ses propres brevets. Design, qualité et fonctionnalité sont les valeurs qui guident la création des stylos MILAN, une catégorie en pleine expansion depuis le lancement de la famille P1 en 2009.

ENCRE FABRIQUÉE EN ALLEMAGNE



0.7 mm

P07
DRY-GEL
GEL INK

1 mm

CAPSULE



1 mm

CAPSULE



1 mm

COMPACT



1 mm

P1
touch
Stylus

1 mm

Stylus



1 mm

sway
<combi duo >

4 FUNCTIONS
METAL BOX

MILAN®

GOLYÓSTOLLAK
PENS
STYLOS

ÍRÁS
WRITING
ÉCRITURE

PATENTED DESIGN

GOLYÓSTOLLAK · PENS · STYLOS

**TOP
SELLER**



rendelési kód: F01175300

rendelési kód: F01175400

rendelési kód: F01175200



rendelési kód: F01175100

1 mm

P1 touch

PATENTED DESIGN

14,1 x 1,7 cm · Ø 1 cm · 7,4 gr INK MADE IN GERMANY

**NEW
DESIGN!**



25 unidades/cajita
units/box
unités/boîte

14,8 x 10,5 x 3,5 cm · 0,22 kg

40 units · 8,80 kg

176510925



8411574036616

176512925



8411574036630

176511925



8411574036623

176513925



8411574036647



21 x 6,5 x 1,8 cm · 32 gr

24 units · 0,90 kg

BWM10253



rendelési kód: F01175BL5



21 x 6,5 x 1,8 cm · 40 gr

24 units · 1,10 kg

BWM10254



rendelési kód: F01175BL4

BWM10327



rendelési kód: MIL000600



20,5 x 7 x 1,5 cm · 31 gr

45 units · 1,55 kg

270 units · 10,80 kg

176510804



rendelési kód: MIL000056



21 x 8,2 x 1,5 cm · 49 gr

24 units · 1,30 kg

BWM10321



rendelési kód: MIL000599



rendelési kód: F01172400

rendelési kód: F01172200



rendelési kód: F01172100

1 mm

P1

PATENTED DESIGN

14,1 x 1,7 cm · Ø 1 cm · 7,9 gr INK MADE IN GERMANY



21 x 6,5 x 2 cm · 36 gr

24 units · 0,94 kg



BWM10445



rendelési kód: MIL000728



21 x 6,5 x 2 cm · 36 gr

24 units · 0,94 kg



BWM10012



rendelési kód: MIL000584



25

u./cajita
u./box
u./boîte

14,3 x 10,5 x 4 cm · 0,20 kg

48 units · 11,20 kg

17651225



8411574005490

17653225



8411574005506

17652225



8411574005513

GOLYÓSTOLLAK · PENS · STYLOS



1 mm

mini P1 touch

PATENTED DESIGN

10,2 x 1,7 cm · Ø 1 cm · 6,6 gr INK MADE IN GERMANY

40 unidades/cajita
units/box
unités/boîte

10,5 x 8 x 8cm · 0,31 kg

36 units · 11,8 kg



176530140



rendelési kód: F01176100



176531140



rendelési kód: F01176200



rendelési kód: F01176D07



1 mm

mini P1 touch colours

PATENTED DESIGN

10,2 x 1,7 cm · Ø 1 cm · 6,6 gr INK MADE IN GERMANY



14 unidades/cajita
units/box
unités/boîte

17 x 13 x 10,5 cm · 0,76 kg

18 units · 15,00 kg



176556914



8411574062639



DISPLAY KIHELYEZÉS

14 KÉSZLET 7 GOLYÓSTOLLAL

14 CASES WITH 7 PENS

14 ÉTUIS DE 7 STYLOS



rendelési kód: F01175D24



1 mm

P1 touch colours

PATENTED DESIGN

14,1 x 1,7 cm · Ø 1 cm · 7,4 gr INK MADE IN GERMANY



21 x 6,5 x 1,8 cm · 40 gr

24 units · 1,10 kg

288 units · 13,2 kg



BWM10487



rendelési kód: MIL000773



VEGYES SZÍNEK

24 unidades/cajita
units/box
unités/boîte

14 x 8 x 4 cm · 0,20 kg

5 units · 1,20 kg

50 units · 13 kg

176555124



8411574049159



MILAN®

GOLYÓSTOLLAK · PENS · STYLOS



rendelési kód: F01175CAM

1 mm

P1

PATENTED DESIGN

14,1 x 1,7 cm · Ø 1 cm · 7,9 gr INK MADE IN GERMANY



20 unidades/cajita
units/box
unités/boîte

14,5 x 8,5 x 8 cm · 0,19 kg

18 units · 3,50 kg

1765729120FN



8411574098089



THE FUN KOLLEKCIÓ
PG. 246



rendelési kód: F01175910

1 mm

P1

PATENTED DESIGN

14,1 x 1,7 cm · Ø 1 cm · 7,9 gr INK MADE IN GERMANY

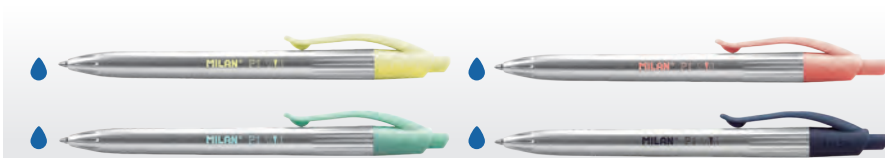

20 unidades/cajita
units/box
unités/boîte

14,5 x 8,5 x 8 cm · 0,19 kg

18 units · 4,10 kg

1765779120



8411574060543

GOLYÓSTOLAK · PENS · STYLOS



1 mm P1 PATENTED DESIGN 14,1 x 1,7 cm · Ø 1 cm · 7,4 gr INK MADE IN GERMANY



rendelési kód: MIL000731

21,2 x 6,5 x 1,5 cm · 19 gr
12 units · 0,27 kg

BWM10446IBG

8411574092513

rendelési kód: MIL000592

21,2 x 6,5 x 1,8 cm · 32 gr
12 units · 0,45 kg

BWM10253IBG

8411574093114

rendelési kód: MIL000585

21,2 x 6,5 x 1,8 cm · 32 gr
12 units · 0,45 kg

BWM10012IBG

8411574092506

rendelési kód: MIL000732

21,2 x 8,2 x 1,5 cm · 23 gr
12 units · 0,31 kg

BWM10447IBG 0,7 mm HB

8411574092544

GOLYÓSTOLL +
RADIÓS
NYOMÓSÍRÓN
PEN + MECHANICAL
PENCIL WITH ERASER
STYLO +
PORTE-MINES
AVEC GOMME

A GOLYÓSTOLL TESTE BIOCIDOT TARTALMAZ. EZÜST-FOSZFÁT ÜVEGGEL (CAS 308069-39-8) KEZELVE, ANTIBAKTERIÁLIS HATÁSÚ.
THE PEN'S BODY INCORPORATES A BIOCID. TREATED WITH SILVER PHOSPHATE GLASS (CAS 308069-39-8) WITH ANTIBACTERIAL EFFECT.
LE CORPS DU STYLO INCLUT UN BIOCID. TRAITÉ AU VERRE DE PHOSPHATE D'ARGENT (CAS 308069-39-8) AVEC EFFET ANTIBACTÉRIEN.

ZSELÉSTOLAK · GEL INK PENS · STYLOS ENCRE GEL

TOP
SELLER



0,7 mm P07 DRY-GEL PATENTED DESIGN 14,3 x 1,5 cm · Ø 1 cm · 7,7 gr INK MADE IN GERMANY

SOFT & DRY
Gels

176540125

8411574050469

176541125

8411574050476

176542125

841157050483

25 unidades/cajita
units/box
unités/boîte

15 x 10,5 x 3,8 cm · 0,22 kg

48 units · 11,30 kg

GOLYÓSTOLAK · PENS · STYLOS



1 mm

CAPSULE PATENTED DESIGN 13,4 x 1,6 cm · Ø 1 cm · 9,7 gr INK MADE IN GERMANY

rendelési kód: F01176CSIL



20 unidades/cajita
units/box
unités/boîte

14,5 x 8,4 x 8 cm · 0,23 kg

18 units · 5 kg

1765649120

8411574078241



0,5 mm HB

21,2 x 8,2 x 1,7 cm · 30 gr

12 units · 0,41 kg

BWM10414

rendelési kód: MIL000693



1 mm

CAPSULE PATENTED DESIGN 13,4 x 1,6 cm · Ø 1 cm · 9,7 gr INK MADE IN GERMANY

rendelési kód: F01176CCOP



20 unidades/cajita
units/box
unités/boîte

14,5 x 8,4 x 8 cm · 0,22 kg

18 units · 5 kg

1765809120

8411574071921

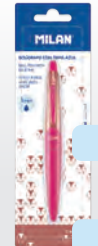

21,2 x 6,5 x 1,8 cm · 18 gr

24 units · 0,56 kg

BWM10392

rendelési kód: MIL000683

BWM10393

rendelési kód: MIL000688



rendelési kód: F01176PSUN



1 mm

COMPACT PATENTED DESIGN 14,1 x 1,7 x 1,4 cm · 12,3 gr INK MADE IN GERMANY

GOLYÓSTOLL + RADIÓS NYOMÓSIRÓN
PEN + MECHANICAL PENCIL WITH ERASER
STYLO + PORTE-MINES AVEC GOMME



20 unidades/cajita
units/box
unités/boîte

14,5 x 8,5 x 8 cm · 0,22 kg

18 units · 5,70 kg

176568920SN

8411574082026



VEGYES SZÍNEK

0,7 mm 2B

21,2 x 6,2 x 1,8 cm · 18 gr

24 units · 0,60 kg

BWM10437

rendelési kód: MIL000716



VEGYES SZÍNEK

0,7 mm 2B

21 x 8,2 x 1,7 cm · 37 gr

24 units · 1,06 kg

BWM10438

rendelési kód: MIL000723

ÉRINTŐKÉPERNYŐS GOLYÓSTOLLAK · BALLPENS WITH TOUCH SCREEN STYLUS ·
 STYLOS AVEC POINTE STYLET POUR ÉCRAN TACTILE



rendelési kód: F011800P1

1 mm

P1 touch Stylus

PATENTED DESIGN

14,3 x 1,7 cm · Ø 1 cm · 10,2 gr INK MADE IN GERMANY



25 unidades/cajita
 units/box
 unités/boîte

14,8 x 10,5 x 3,5 cm · 0,52 kg

40 units · 8,80 kg

1765914925B



8411574100690



CSAVAROS
 MECHANIKÁVAL
 WITH TWIST
 MECHANISM
 AVEC OUVERTURE
 ROTATIVE



rendelési kód: F01180COP

1 mm

Stylus

PATENTED DESIGN

13,8 x 1,3 cm · Ø 1 cm · 6,5 gr INK MADE IN GERMANY



24 unidades/cajita
 units/box
 unités/boîte

15,5 x 12,5 x 9,5 cm · 0,20 kg

50 units · 11,50 kg

176593924



8411574078630

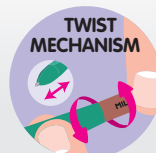

CSAVAROS
 MECHANIKÁVAL
 WITH TWIST
 MECHANISM
 AVEC OUVERTURE
 ROTATIVE



CSERÉLHETŐ TESTTEL ELLÁTOTT GOLYÓSTOLLAK · PENS WITH INTERCHANGEABLE BODIES · STYLOS À CORPS INTERCHANGEABLES

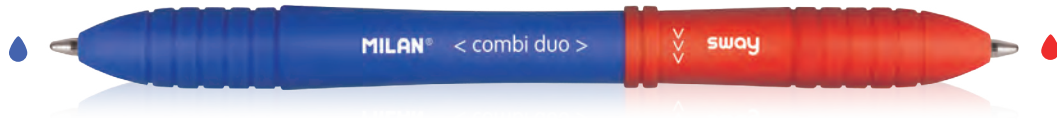

rendelési kód: F01174DUO

1 mm

sway < combi duo >

PATENTED DESIGN

13,7 x 1,7 cm · Ø 1,2 cm · 10,9 gr INK MADE IN GERMANY



5 GOLYÓSTOLL, 10 SZÍN,
25 KOMBINÁCIÓ
5 PENS, 10 COLOURS,
25 COMBINATIONS
5 STYLOS, 10 COULEURS,
25 COMBINAISONS



rendelési kód: MIL000105



50 unidades/cajita
units/box
unités/boîte

23 x 14 x 6,5 cm · 0,66 kg

12 units · 7,96 kg

176582950



8411574074557



10 estuches/cajita
cases/box
étuis/boîte

14,5 x 14,3 x 8,5 cm · 0,67 kg

8 units · 5,71 kg

176584905



8411574086130



DISPLAY KIHELYEZÉS

10 KÉSZLET
5 GOLYÓSTOLLAL
10 CASES
WITH 5 PENS
10 ÉTUIS
DE 5 STYLOS

rendelési kód: MIL000108



10 unidades/cajita
units/box
unités/boîte

13,7 x 6 x 3,5 cm · 130 gr

32 units · 4,20 kg

17658423210



8411574086086



rendelési kód: F01174BL2

21 x 6,5 x 1,8 cm · 18 gr

24 units · 0,74 kg

BWM10399



8411574075752



GOLYÓSTOLL BETÉTEK · BALL PEN REFILLS · RECHARGES STYLOS



P1 touch

50 unidades/cajita
units/box
unités/boîte

11 x 3 x 1,7 cm · 48 gr

100 units · 5,10 kg

1765025050

rendelési kód: F02175100

1765025150

rendelési kód: F02175200

1765025250

rendelési kód: F02175400

1765025350

rendelési kód: F02175300

4 FUNKCIÓS FÉM GOLYÓSTOLL: KÉK ÉS PIROS BETÉT, CERUZA BETÉT ÉS RADÍR
GIFT BALLPEN WITH 4 FEATURES: 2 INK COLOURS, PENCIL AND ERASER
STYLO 4 FONCTIONS (POUR OFFRIR): DEUX COULEURS D'ENCRE, PORTE-MINES ET GOMME

Ø 9 mm

METAL BOX

rendelési kód: F01174910



MADE IN JAPAN 13 x 1,15 cm · Ø 9 mm · 19,3 gr

4 FUNKCIÓS
 PIROS ÉS KÉK GOLYÓSTOLL, NYOMÓSIRÓN ÉS RADÍR

4 FUNCTIONS:
 BLUE AND RED PEN, MECHANICAL PENCIL AND ERASER

4 FONCTIONS:
 STYLO À BILLE BLEU ET ROUGE, PORTE-MINES ET GOMME

0.5 mm
 HB

rendelési kód: MIL000102

2 GOLYÓSTOLL BETÉT ÉS 1 RADÍR
 2 BAL PEN REFILLS AND 1 ERASER
 2 RECHARGES STYLO ET 1 GOMME

14 x 7 x 0,5cm - 3 gr
 100 units - 0,44 kg

LWM10404
 8411574078777



18 x 4 x 2 cm · 62 gr
 25 units · 1,70 kg

1772601
 8411574044086





0.5 mm

HB

CAPSULE

>>> slim <<<



0.7 mm

2B

CAPSULE



0.7 mm

2B

CAPSULE



1.3 mm

2B

CAPSULE



0.7 mm

2B

COMPACT



0.7 mm

2B

COMPACT



B

PUHA GRAFT
SOFT HARDNESS GRAPHITE
GRAPHITE DURETÉ SOUPLE

2B

NAGYON PUHA GRAFT
VERY SOFT HARDNESS GRAPHITE
GRAPHITE DURETÉ TRES SOUPLE

HB

KÖZEPES KEMÉNYSÉGŰ GRAFIT
MEDIUM HARDNESS GRAPHITE
GRAPHITE DURETÉ MOYENNE



0.5 mm

HB

PL1

0.7 mm

HB

PL1

0.9 mm

B

PL1

0.9 mm

2B

PL1

0.7 mm

HB

PL1

5.2 mm

B

PL1



MILAN®

RADÍRÓS NYOMÓSÍRÓNOK
MECHANICAL PENCILS WITH ERASER
PORTE-MINES AVEC GOMME

A MILAN mechanikus ceruzák egyediek és könnyen felismerhetők eredeti és színes kialakításukról. Számos modell létezik radíros, illetve különböző vastagságú és keménységű kivitelben.

MILAN mechanical pencils are unique and recognisable for their original and colourful designs. There are many models with rubbers and leads of different hardnesses and thicknesses.

Les porte-mines MILAN sont des produits uniques qui sont reconnaissables à leurs styles originaux et colorés. Grande variété de modèles avec gomme et mines de différentes duretés et épaisseurs.

PATENTED DESIGN

MILAN®

NYOMÓSIRÓN HOSSZÚ RADÍRRAL · MECHANICAL PENCILS WITH LONG ERASER ERASER PORTE-MINES AVEC GOMME LONGUE

rendelési kód: F311690HB



0.5 mm

HB



CAPSULE >>> slim <<< PATENTED DESIGN 13 x 1,4 x 1,2 cm · 10,1 gr

20 unidades/cajita
units/box
unités/boîte

13 x 10 x 8,5cm · 0,25 kg

18 units · 5,20 kg

185024920



8411574059653

rendelési kód: F41185006

x4 PÓTRADÍR
SPARE ERASERS
GOMMES DE RECHANGE

14 x 8,2 x 0,7 cm · 12 gr

24 units · 0,38 kg

BTM10311



8411574050872

NYOMÓSIRÓN NAGY RADÍRRAL · MECHANICAL PENCILS WITH BIG ERASER PORTE-MINES AVEC GRANDE GOMME

rendelési kód: F3117302B



0.7 mm

2B



CAPSULE PATENTED DESIGN 13 x 1,8 x 1,6 cm · 15,7 gr

20 unidades/cajita
units/box
unités/boîte

13 x 12 x 11 cm · 0,41 kg

18 units · 8,1 kg

18507920



8411574047698

rendelési kód: F41161004

x4 PÓTRADÍR
SPARE ERASERS
GOMMES DE RECHANGE

14 x 6 x 1,1 cm · 20 gr

24 units · 0,56 kg

BTM10299



8411574047766

rendelési kód: F3117402B

MIX

SERIES



0.7 mm

2B



CAPSULE PATENTED DESIGN 13 x 1,8 x 1,6 cm · 15,7 gr

FELCSERÉLHETŐ SZÍNEK · INTERCHANGEABLE
COLOURS · COULEURS INTERCHANGEABLES32 unidades/cajita
units/box
unités/boîte

16,5 x 16 x 8,5 cm · 0,70 kg

1 units · 0,76 kg

6 units · 5,20 kg

185021932



8411574055730

MECHANIKUS CERUZA NAGY RADÍRRAL · MECHANICAL PENCILS WITH BIG ERASER PORTE-MINES AVEC GRANDE GOMME

rendelési kód: F3117902B



1.3 mm **2B** CAPSULE **PATENTED DESIGN** 13 x 1,8 x 1,6 cm · 15,7 gr



20 unidades/cajita
units/box
unités/boîte

13 x 12 x 11 cm · 0,41 kg

18 units · 8,1 kg

18504920

8411574049555



rendelési kód: MIL000807

x2

VEGYES SZÍNEK

21 x 6,5 x 1,7 cm · 34 gr

24 units · 0,89 kg

BYM10306

8411574049562

rendelési kód: F3117502B



0.7 mm **2B** COMPACT **PATENTED DESIGN** 13 x 1,8 x 1,6 cm · 13,4 gr



20 unidades/cajita
units/box
unités/boîte

13 x 12 x 11 cm · 0,34 kg

18 units · 6,90 kg

18502920

8411574050377



rendelési kód: F41161004

x4 PÖTRADÍR
SPARE ERASERS
GOMMES DE RECHANGE

14 x 6 x 1,1 cm · 20 gr

24 units · 0,56 kg

BTM10299

8411574047766

rendelési kód: F31175C2B



0.7 mm **2B** COMPACT **PATENTED DESIGN** 13 x 1,8 x 1,6 cm · 13,4 gr



20 unidades/cajita
units/box
unités/boîte

13 x 12 x 11 cm · 0,34 kg

18 units · 6,90 kg

18502920SN

8411574083443



rendelési kód: MIL000723

0.7 mm 2B

VEGYES SZÍNEK

21 x 6,5 x 1,7 cm · 34 gr

24 units · 0,89 kg

BWM10438

8411574088899

MILAN®

NYOMÓSIRÓN HOSSZÚ RADÍRRAL · MECHANICAL PENCILS WITH LONG ERASER ERASER PORTE-MINES AVEC GOMME LONGUE



0.5 mm

HB



PL1

PATENTED DESIGN

14,4 x 1,5 x 1,1 cm · 10,7 gr

rendelési kód: F311700BL



x2

VEGYES SZÍNEK

21 x 6,5 x 1,2 cm · 22 gr

24 units · 0,70 kg

BYM10310



8411574050780

RADÍR CSAVAROS MECHANIKÁVAL · ERASER WITH TWIST
MECHANISM · GOMME À OUVERTURE ROTATIVE



0.9 mm

2B



PL1

PATENTED DESIGN

14,4 x 1,5 x 1,1 cm · 10,7 gr



x2

VEGYES SZÍNEK

18 x 6 x 1,3 cm · 22 gr

24 units · 0,60 kg

144 units · 4,10 kg

BYM10318



8411574051909

RADÍR CSAVAROS MECHANIKÁVAL · ERASER WITH TWIST
MECHANISM · GOMME À OUVERTURE ROTATIVE

rendelési kód: MIL000809



CERUZABETÉT CSERÉJE · HOW TO CHANGE THE LEAD · COMMENT CHANGER LA MINE

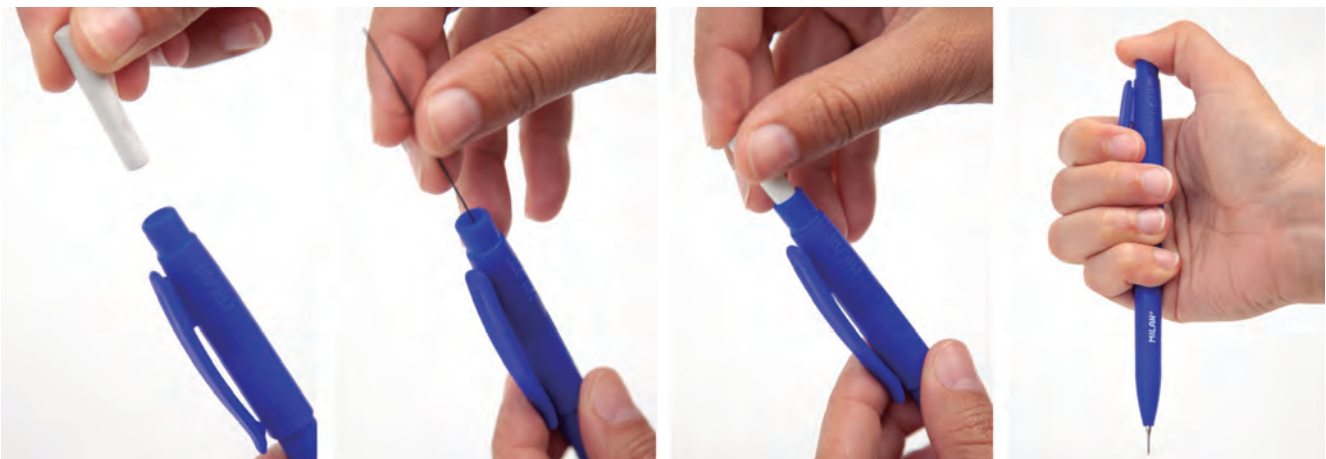

A CERUZABETÉT CSERÉJÉHEZ CSAVARJA EL A NYOMÓSIRÓN TESTÉT ÉS VEGYE KI A RADÍRT! HELYEZZE A TESTBE A CERUZABETÉT! HELYEZZE VISSZA A RADÍRT ÉS CSAVARJA VISSZA A TESTET! NYOMJA MEG A NYOMÓSIRÓN VÉGÉT A BETÉT ADAGOLÁSÁHOZ!

To change the lead, rotate the body of the mechanical pencil and remove the rubber. Insert the lead. Replace the eraser and rotate the body of the mechanical pencil. Press the end of the mechanical pencil to extend the lead.

Pour changer la mine, faire pivoter le corps du porte-mine et retirer la gomme. Introduire la mine. Remplacer la gomme et faire pivoter le corps du porte-mine. Appuyer sur l'extrémité du porte-mine pour allonger la mine.

NYOMÓSIRÓN HOSSZÚ RADÍRRAL · MECHANICAL PENCILS WITH LONG ERASER
PORTE-MINES AVEC GOMME LONGUE

rendelési kód: F311700HB



0.5 mm

HB



PL1

PATENTED DESIGN 14,4 x 1,5 x 1,1 cm · 10,7 gr

RADÍR CSAVAROS MECHANIKÁVAL · ERASER WITH TWIST MECHANISM · GOMME À OUVERTURE ROTATIVE



20 unidades/cajita
units/box
unités/boîte

14,5 x 8,5 x 8 cm · 0,24 kg

18 units · 4,80 kg

185010920



8411574050391



rendelési kód: F41185006



x4 PÓTRADÍR
SPARE ERASERS
GOMMES DE RECHANGE

14 x 8,2 x 0,7 cm · 12 gr

24 units · 0,38 kg

BTM10311



8411574050872

rendelési kód: F311770HB



0.7 mm

HB



PL1

PATENTED DESIGN 14,4 x 1,5 x 1,1 cm · 10,7 gr

RADÍR CSAVAROS MECHANIKÁVAL · ERASER WITH TWIST MECHANISM · GOMME À OUVERTURE ROTATIVE



20 unidades/cajita
units/box
unités/boîte

14,5 x 8,5 x 8 cm · 0,24 kg

18 units · 4,80 kg

185011920



8411574050407



NÉZD MEG A
VIDEÓT

rendelési kód: F3117802B



0.9 mm

B



PL1

PATENTED DESIGN 14,4 x 1,5 x 1,1 cm · 10,7 gr

RADÍR CSAVAROS MECHANIKÁVAL · ERASER WITH TWIST MECHANISM · GOMME À OUVERTURE ROTATIVE



20 unidades/cajita
units/box
unités/boîte

14,5 x 8,5 x 8 cm · 0,24 kg

18 units · 4,80 kg

185012920



8411574050414



NEW!

MILAN®**NYOMÓSIRÓN HOSSZÚ RADÍRRAL · MECHANICAL PENCILS WITH LONG ERASER**
PORTE-MINES AVEC GOMME LONGUE

rendelési kód: F3118002B



0,9 mm

2B



PL1

PATENTED DESIGN

14,4 x 1,5 x 1,1 cm · 10,7 gr

RADÍR CSAVAROS MECHANIKÁVAL · ERASER WITH TWIST MECHANISM · GOMME À OUVERTURE ROTATIVE

20 unidades/cajita
units/box
unités/boîte

14,5 x 8,5 x 8 cm · 0,24 kg

18 units · 4,80 kg

185012920FN



8411574101703



SERIES



0,7 mm

HB



PL1

PATENTED DESIGN

14,4 x 1,5 x 1,1 cm · 10,7 gr

RADÍR CSAVAROS MECHANIKÁVAL · ERASER WITH TWIST MECHANISM · GOMME À OUVERTURE ROTATIVE

**A NYOMÓSIRÓN TESTE BIOCIDOT TARTALMAZ. EZÜST-FOSZFÁT ÜVEGGEL (CAS30869-39-8) KEZELVE, ANTIBAKTERIÁLIS HATÁSÚ.****THE MECHANICAL PENCIL'S BODY INCORPORATES A BIOCID. TREATED WITH SILVER PHOSPHATE GLASS (CAS 308069-39-8) WITH ANTIBACTERIAL EFFECT.****LE CORPS DU PORTE-MINES INCLUT UN BIOCID. TRAITÉ AU VERRE DE PHOSPHATE D'ARGENT (CAS 308069-39-8) AVEC EFFET ANTIBACTÉRIEN.**GÖLYÖSTOLL + NYOMÓSIRÓN
PEN + MECHANICAL PENCIL
STYLO + PORTE-MINES

0,7 mm HB

21,2 x 8,2 x 1,5 cm · 23 gr

12 units · 0,31 kg

BWM10447IBG



rendelési kód: MIL000732



BWM10458IBGGR



rendelési kód: MIL000749

BWM10458IBGP



rendelési kód: MIL000750

BWM10458IBGG



rendelési kód: MIL000746

21 x 8,2 x 2,1 cm · 27 gr

12 units · 0,37 kg

FÉM NYOMÓSIRÓN · MECHANICAL PENCILS · PORTE-MINES

rendelési kód: F311800HB



BEÉPÍTETT HEGYEZŐ

5,2 mm

B

ART

15 x Ø 1,1 cm · 26,4 gr

rendelési kód: F32180200

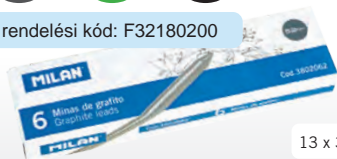
x6 CERUZABETÉT
SPARE LEADS
MINES DE RECHANGE

13 x 3,5 x 2,2 cm · 30 gr

100 units · 3,40 kg

3802062



8411574047261

rendelési kód: MIL000665

NYOMÓSIRÓN +
CERUZABETÉT
MECHANICAL PENCIL +
SPARE LEADS
PORTE-MINES +
MINES DE RECHANGE

21 x 8,2 x 1 cm · 70 gr

25 units · 1,90 kg

BWM10353



8411574063896



6

u./cajita
u./box
u./boîte

15 x 9,5 x 1,5 cm · 0,18 kg

50 units · 9,10 kg

535206



8411574046943

CERUZABETÉTEK · SPARE LEADS · MINES DE RECHANGE



14 x 8,2 x 1 cm · 18 gr

48 units · 0,98 kg

BWM10320

rendelési kód: MIL000598



24 unidades/cajita
units/box
unités/boîte

7,7 x 5,5 x 4 cm · 0,26 kg

36 units · 9,80 kg

1851040524

rendelési kód: MIL000058

x120
BETÉT
LEADS
MINES

0.5
mm

HB

7,5 x 1,9 x 0,8 cm · 10,5 gr



24 unidades/caixa
unité/scatola
sztuk/pudełko

8 x 8 x 5,5 cm · 0,19 kg

36 units · 7,20 kg

1851070524

rendelési kód: F321730HB

x12
BETÉT
LEADS
MINES

0.5
mm

HB

7,5 x 1,9 x 0,8 cm · 7,5 gr



14 x 8,2 x 1 cm · 20 gr

48 units · 0,85 kg

BWM10333

rendelési kód: MIL000601



24 unidades/cajita
units/box
unités/boîte

7,7 x 5 x 4,5 cm · 0,21 kg

36 units · 7,80 kg

1851071524

rendelési kód: F321740HB

x12
BETÉT
LEADS
MINES

0.7
mm

HB

7,5 x 1,9 x 0,8 cm · 7,7 gr



24 unidades/cajita
units/box
unités/boîte

7,5 x 5 x 4,5 cm · 0,21 kg

36 units · 7,80 kg

1851071424

rendelési kód: F3217402B

x12
BETÉT
LEADS
MINES

0.7
mm

2B

7,5 x 1,9 x 0,8 cm · 7,7 gr



14 x 8,2 x 1 cm · 14 gr

48 units · 0,78 kg

BWM10334

rendelési kód: MIL000602



24 unidades/cajita
units/box
unités/boîte

7,5 x 5 x 4,5 cm · 20 gr

36 units · 7,50 kg

1851070924

rendelési kód: F3217502B

x12
BETÉT
LEADS
MINES

0.9
mm

2B

7,5 x 1,9 x 0,8 cm · 8 gr



24 unidades/cajita
units/box
unités/boîte

7,5 x 5 x 4,5 cm · 0,21 kg

36 units · 7,80 kg

1851071024

rendelési kód: MIL000059

x12
BETÉT
LEADS
MINES

0.9
mm

B

7,5 x 1,9 x 0,8 cm · 7,7 gr



NEW!



14 x 8,2 x 1 cm · 16 gr

48 units · 0,83 kg

BWM10335

rendelési kód: MIL000605



24 unidades/cajita
units/box
unités/boîte

7,5 x 5 x 4,5 cm · 0,24 kg

36 units · 9,80 kg

1851071324

rendelési kód: F3217902B

x12
BETÉT
LEADS
MINES

1.3
mm

2B

7,5 x 1,9 x 0,8 cm · 9 gr





6B

MŰVÉSZI RAJZOKHOZ AJÁNLOTT

4B

APPROPRIATE FOR ARTISTIC DRAWING

2B

ADAPTÉS AU DESSIN ARTISTIQUE



B

KÖZEPES ERŐSSÉG, ÍRÁSHOZ ÉS RAJZOLÁSHOZ AJÁNLOTT

MEDIUM HARDNESSES, RECOMMENDED FOR WRITING AND DRAWING

HB

CATÉGORIES MOYENNES, RECOMMANDÉES POUR L'ÉCRITURE ET LE DESSIN



H

LEHETŐVÉ TESZ VÉKONYABB, MŰSZAKI JELLEGŰ

RAJZOLÁST

2H

ALLOWS THINNER, MORE TECHNICAL LINES

PERMET DES LIGNES PLUS FINES ET TECHNIQUES



MILAN®

GRAFIT CERUZÁK
GRAPHITE PENCILS
CRAYONS GRAPHITE

LPS - LEAD PROTECTION SYSTEM: EGY RENDSZER, AMIBEN A CERUZABELET A FÁHOZ ILLESZTIK, EZÁLTAL AZ ELLENÁLLÓBBÁ TESZI A CERUZABÉLT A TÖRÉSEL SZEMBEN.



LPS - LEAD PROTECTION SYSTEM: SYSTEM OF ATTACHING THE LEAD TO THE WOOD, WHICH PROTECTS THE LEAD AND INCREASES ITS RESISTANCE TO BREAKING.

LPS - LEAD PROTECTION SYSTEM: SYSTÈME D'ADHÉRENCE DE LA MINE AU BOIS, QUI PROTÈGE LA MINE ET AUGMENTE SA RÉSISTANCE À LA CASSE.



NAGYON ELLENÁLLÓ ÉS SIMA FA, KIVÁLÓAN LEHET HEGYEZNI.

VERY RESISTANT AND SMOOTH WOOD, ALLOWING SMOOTH SHARPENING.

BOIS TRÈS RÉSISTANT ET SOUPLE, CE QUI PERMET UNE TAILLE FACILE.



SIMÁBB CERUZABÉL, AMELY LEHETŐVÉ TESZI A MÉG EGYSÉGESEBB SZÍNEZÉST.

SMOOTHER LEAD, ALLOWING EVEN LINES WITH CONSISTENT COLOURS.

UNE MINE PLUS SOUPLE, QUI PERMET UN TRAIT UNIFORME ET DES COULEURS HOMOGÈNES.



MINŐSÉGI, TARTÓS ÉS BIZTONSÁGOS PIGMENTET HASZNÁLNAK. EZEK MEGFELELNEK AZ EN71-ES EURÓPAI BIZOTTSÁGI SZABÁLYZATNAK ÉS AZ EGYESÜLT ÁLLAMOK ASTM RENDELETÉNEK.

QUALITY, SOLID AND SAFE PIGMENTS ARE USED. THEY COMPLY WITH EUROPEAN SAFETY REGULATION EN71 AND THE UNITED STATES ASTM REGULATION.

LES PIGMENTS UTILISÉS SONT DE QUALITÉ, SOLIDES ET INOFFENSIFS. ILS SONT CONFORMES AUX NORMES DE SÉCURITÉ EUROPÉENNE EN71 ET ÉTATSUNIENNE ASTM.

FÁBÓL KÉSZÜLT GRAFIT CERUZÁK · GRAPHITE PENCILS MADE OF WOOD
 CRAYONS GRAPHITE EN BOIS



AJÁNLOTT
 RADÍR
 SUIVABLE ERASER
 GOMME À EFFACER
 ADEQUATE



Mod. 1420
 5,5 x 2,3 x 1,3 cm
 PG. 13 >



Mod. 412
 5,2 x 3,5 x 1,3 cm
 PG. 18 >

**TOP
 SELLER**



rendelési kód: F3317206B

6B **Ø 3 mm** **ART**
 17,5 x 0,73 cm · 5,2 gr

12 unidades/cajita
 units/box
 unités/boîte

20,5 x 4,5 x 1,5 cm - 70 gr

12 units · 0,84 kg

96 units - 7,10 kg

071230612



8411574095262



AJÁNLOTT
 RADÍR
 SUIVABLE ERASER
 GOMME À EFFACER
 ADEQUATE



DUST
 FREE

Mod. 5020
 6,1 x 2,3 x 1,2 cm
 PG. 12 >



Mod. 4824
 7,4 x 2 x 1 cm
 PG. 25 >

**TOP
 SELLER**



rendelési kód: F3317204B

4B **Ø 2,4 mm** **ART**
 17,5 x 0,73 cm · 4,8 gr

12 unidades/cajita
 units/box
 unités/boîte

20,5 x 4,5 x 1,5 cm - 58 gr

12 units · 0,80 kg

96 units - 6,70 kg

071230512



8411574095255



AJÁNLOTT
 RADÍR
 SUIVABLE ERASER
 GOMME À EFFACER
 ADEQUATE



Mod. 4020
 5,5 x 2,3 x 1,3 cm
 PG. 23 >

**TOP
 SELLER**

PENCILS
 SET
 PG.77



rendelési kód: F3317202B

2B **Ø 2,4 mm** **ART**
 17,5 x 0,73 cm · 4,6 gr

12 unidades/cajita
 units/box
 unités/boîte

20,5 x 4,5 x 1,5 cm - 62 gr

12 units · 0,75 kg

96 units - 6,80 kg

071230412



8411574023982



AJÁNLOTT
 RADÍR
 SUIVABLE ERASER
 GOMME À EFFACER
 ADEQUATE



DUST
 FREE

Mod. 5020
 6,1 x 2,3 x 1,2 cm
 PG. 12 >



NÉZD MEG A
 VIDEÓT!

**TOP
 SELLER**



rendelési kód: F3317201B

B **Ø 2,4 mm** **ART**
 17,5 x 0,73 cm · 4,7 gr

12 unidades/cajita
 units/box
 unités/boîte

20,5 x 4,5 x 1,5 cm - 64 gr

12 units · 0,76 kg

96 units - 6,30 kg

071230212



8411574023951

FÁBÓL KÉSZÜLT GRAFIT CERUZÁK · GRAPHITE PENCILS MADE OF WOOD
 CRAYONS GRAPHITE EN BOIS



AJÁNLOTT
 RADÍR
 SUIVABLE ERASER
 GOMME À EFFACER
 ADEQUATE



Mod. 320
 6,1 x 2,3 x 1,2 cm
 PG. 16 >

**TOP
 SELLER**

PENCILS
 SET
 PG. 77



rendelési kód: F331720HB

HB **ø2.2 mm** **ART**

17,5 x 0,73 cm · 4,7 gr

12 unidades/cajita
 units/box
 unités/boîte

20,5 x 4,5 x 1,5 cm · 58 gr

12 units · 0,72 kg

96 units · 6,30 kg

071230312



8411574023975



AJÁNLOTT
 RADÍR
 SUIVABLE ERASER
 GOMME À EFFACER
 ADEQUATE



Mod. 4024
 5 x 2,3 x 0,9 cm
 PG. 23 >

**TOP
 SELLER**

PENCILS
 SET
 PG. 77



rendelési kód: F3317201H

H **ø 2 mm** **ART**

17,5 x 0,73 cm · 4,5 gr

12 unidades/cajita
 units/box
 unités/boîte

20,5 x 4,5 x 1,5 cm · 60 gr

12 units · 0,70 kg

96 units · 6,10 kg

071230112



8411574023944



AJÁNLOTT
 RADÍR
 SUIVABLE ERASER
 GOMME À EFFACER
 ADEQUATE



Mod. 4020
 5,5 x 2,3 x 1,3 cm
 PG. 23 >

**TOP
 SELLER**

PENCILS
 SET
 PG. 77



rendelési kód: F3317202H

2H **ø 2 mm** **ART**

17,5 x 0,73 cm · 4,6 gr

12 unidades/cajita
 units/box
 unités/boîte

20,5 x 4,5 x 1,5 cm · 58 gr

12 units · 0,72 kg

96 units · 6,30 kg

071230012



8411574095248



AJÁNLOTT
 RADÍR
 SUIVABLE ERASER
 GOMME À EFFACER
 ADEQUATE



Mod. 6024
 5 x 2,3 x 0,9 cm
 PG. 26 >

**TOP
 SELLER**

PENCILS
 SET
 PG. 77



rendelési kód: F331710HB

HB **ø2.2 mm**

17,5 x 0,75 cm · 4,6 gr

12 unidades/cajita
 units/box
 unités/boîte

20,5 x 4,5 x 1,5 cm · 60 gr

12 units · 0,75 kg

96 units · 6,50 kg

80001



8411574800019

FÁBÓL KÉSZÜLT GRAFIT CERUZÁK · GRAPHITE PENCILS MADE OF WOOD
 CRAYONS GRAPHITE EN BOIS



rendelési kód: F331730HB



HB ø2.2 mm
 17,5 x 0,75 cm · 4,6 gr

12 unidades/cajita
 units/box
 unités/boîte

20,5 x 4,5 x 1,5 cm · 60 gr

12 units · 0,80 kg

96 units · 6,70 kg

07121212FSC



8411574087687



rendelési kód: F331780HB



HB ø2.2 mm
 17,5 x 0,73 cm · 4,9 gr

48 unidades/cajita
 units/box
 unités/boîte

ø 6,5 x 17,2 cm · 0,24 kg

6 units · 1,60 kg

24 units · 6,90 kg

0711315148SH



8411574079958



**TOP
 SELLER**



rendelési kód: F3317406B



6B ø3.5 mm **ART**
 17,5 x 1 cm · 8,8 gr

6 unidades/cajita
 units/box
 unités/boîte

20,5 x 6 x 1,2 cm · 57 gr

24 units · 1,42 kg

144 units · 9 kg

071260606



8411574100508



rendelési kód: F331740HB



HB ø3.5 mm **ART**
 17,5 x 1 cm · 8,8 gr

12 unidades/cajita
 units/box
 unités/boîte

20,5 x 6 x 2 cm · 113 gr

12 units · 1,4 kg

72 units · 8,60 kg

0712612



8411574050452



FÁBÓL KÉSZÜLT RADÍROS GRAFIT CERUZÁK · GRAPHITE PENCILS MADE OF WOOD WITH ERASER · CRAYONS GRAPHITE EN BOIS AVEC GOMME



+ GOMA
MILAN
ERASER



MAXI

2 GRAFIT CERUZA RADÍRRAL ÉS 1 MAXI HEGYEZŐVEL
2 GRAPHITE PENCIL WITH ERASER + 1 SHARPENER MAXI
2 CRAYONS GRAPHITE AVEC GOMME + 1 TAILLE-CRAYONS MAXI



rendelési kód: MIL000695

HB Ø3,5 mm

19 x 1 cm · 10,5 gr

12 unidades/cajita
units/box
unités/boîte

25 x 7,2 x 1,5 cm · 37 gr

12 units · 0,51 kg

144 units · 5,80 kg

BWM10427



8411574085447



+ GOMA
MILAN
ERASER



TOP
SELLER

rendelési kód: F331750HB



HB Ø2,2 mm

19 x 0,75 cm · 5,5 gr

12 unidades/cajita
units/box
unités/boîte

22 x 4,5 x 1,5 cm · 78 gr

12 units · 1 kg

96 units · 7,90 kg

0712370312



8411574053446

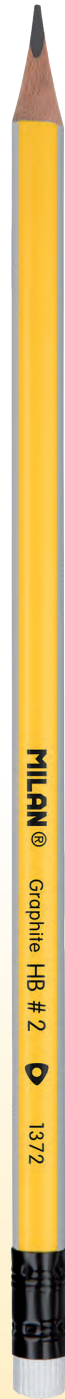

+ GOMA
MILAN
ERASER



rendelési kód: MIL000047



HB Ø2,2 mm

19 x 0,75 cm · 5,5 gr

12 unidades/cajita
units/box
unités/boîte

22 x 4,5 x 1,5 cm · 78 gr

12 units · 1 kg

96 units · 7,90 kg

071237212



8411574102724



+ GOMA
MILAN
ERASER



rendelési kód: F331770HB



HB Ø2,2 mm

19 x 0,75 cm · 5,5 gr

12 unidades/cajita
units/box
unités/boîte

22 x 4,5 x 1,5 cm · 70 gr

12 units · 0,98 kg

96 units · 8,30 kg

0712170312



8411574073581

FÁBÓL KÉSZÜLT RADÍROS GRAFIT CERUZÁK · GRAPHITE PENCILS MADE OF WOOD WITH ERASER · CRAYONS GRAPHITE EN BOIS AVEC GOMME



+ GOMA
MILAN
ERASER



rendelési kód: F331781HB



HB Ø2.2 mm

19 x 0,62 cm · 5,5 gr

12 unidades/cajita
units/box
unités/boîte

22 x 4,5 x 1,5 cm · 70 gr

12 units · 0,92 kg

96 units · 7,70 kg

071212112FC



8411574087694



+ GOMA
MILAN
ERASER

Black
Wood

COPPER
SERIES

GRAFIT CERUZÁK
GRAPHITE PENCILS
CRAYONS GRAPHITE

rendelési kód: F331800HB



HB Ø2.2 mm

19 x 0,75 cm · 6,5 gr



24 unidades/cajita
units/box
unités/boîte

19,5 x 6 x 2,2 cm · 0,14 kg

6 units · 0,91 kg

48 units · 7,50 kg

071421724



8411574095408



+ GOMA
MILAN
ERASER

Black
Wood

SUNSET
SERIES

GRAFIT CERUZÁK
GRAPHITE PENCILS
CRAYONS GRAPHITE

TOP
SELLER

rendelési kód: F331782HB



HB Ø2.2 mm

19 x 0,75 cm · 5,1 gr



24 unidades/cajita
units/box
unités/boîte

19,5 x 6 x 2,2 cm · 0,14 kg

6 units · 0,91 kg

48 units · 7,50 kg

071622724



8411574093756

AKVARELL GRAFIT CERUZA
 WATER SOLUBLE GRAPHITE PENCILS
 CRAYONS GRAPHITE AQUARELLABLES

GRAFIT CERUZA KÉSZLET ·
 PENCIL SET SET DE CRAYONS

MILAN® ART

NEW!

rendelési kód: F33181K03

rendelési kód: F33172BL1

rendelési kód: MIL000812

rendelési kód: MIL000792

rendelési kód: MIL000811

3 unidades/cajita
 units/box
 unités/boîte

22,5 x 5,3 x 0,9 cm · 30 gr

12 units · 0,36 kg

144 units · 4,7 kg

0772142B03

8411574105954

2B **ø3.5 mm** **ART**

**VÍZBEN OLDÓDÓ
 WATER SOLUBLE
 AQUARELLABLE**

**VASTAG
 CERUZABÉL**

17,4 x 0,62 cm · 4,8 gr



rendelési kód: F33172BL1

3 GRAFIT CERUZA + 1 RADÍR + 1 HEGYEZŐ

3 GRAPHITE PENCILS + 1 ERASER + 1 SHARPENER

3 CRAYONS GRAPHITE + 1 GOMME + 1 TAILLE-CRAYONS

HB B 2B

21 x 8,2 x 1,5 cm · 50 gr

25 units · 1,30 kg

BYM10290

8411574046189

rendelési kód: MIL000812

4 GRAFIT CERUZA + 1 RADÍR

4 GRAPHITE PENCILS + 1 ERASER

4 CRAYONS GRAPHITE + 1 GOMME

HB HB B 2B

21 x 8,2 x 1,5 cm · 53 gr

25 units · 1,30 kg

BYM10344

8411574060192

rendelési kód: MIL000792

3 GRAFIT CERUZA + 1 RADÍR + 1 HEGYEZŐ

3 GRAPHITE PENCILS + 1 ERASER + 1 SHARPENER

3 CRAYONS GRAPHITE + 1 GOMME + 1 TAILLE-CRAYONS

HB

21 x 8,2 x 1,5 cm · 50 gr

25 units · 1,75 kg

BYM10016

8411574026471

rendelési kód: MIL000811

2 GRAFIT CERUZA + 2 GOLYÓSTOLL + 1 RADÍR + 1 HEGYEZŐ

2 GRAPHITE PENCILS + 2 PENS + 1 ERASER + 1 SHARPENERS

2 CRAYONS GRAPHITE + 2 STYLOS + 1 GOMME + 1 TAILLE-CRAYONS

HB H

21 x 8,2 x 1,5 cm · 85 gr

25 units · 2,10 kg

BYM10336

8411574055341



HENGERES TEST
 CIRCULAR
 CIRCULAIRE



HÁROMSZÖG TEST
 TRIANGULAR
 TRIANGULAIRE



HATSZÖG TEST
 HEXAGONAL
 HEXAGONAL



MAXI
 MAXIhex 241 - Mediterranean Blue CE
 Irregular 231 - Tropical Yellow CE
 hexagonal 211 - Strawberry Red CE
 hexagonal 212FC - Mandarin FSC® C156918 CE
 THICKlead 213 - Grass Green CE
 aquarell 431 - Bloom Pink CE
 THICKlead aquarell 174 - Coral Red CE
 2B
 4B
 6B
 TODOGRAPHITE HB 181
 TODOGRAPHITE 4B 181
 TODOGRAPHITE 8B 181
 TODOCOLOR 481 - Grass Green
 ZSÍRKRÉTA
 MAXI

VASTAG CERUZABÉL VÍZBEN OLDÓDÓ

VÍZBEN OLDÓDÓ VASTAG CERUZABÉL

ART ART ART ART

MILAN®

SZÍNES CERUZÁK
COLOUR PENCILS
CRAYONS DE COULEUR



LPS - LEAD PROTECTION SYSTEM: EGY RENDSZER, AMIBEN A CERUZABELET A FÁHOZ ILLESZTIK, EZÁLTAL AZ ELLENÁLLÓBBÁ TESZI A CERUZABÉLT A TÖRÉSEL SZEMBEN.

LPS - LEAD PROTECTION SYSTEM: SYSTEM OF ATTACHING THE LEAD TO THE WOOD, WHICH PROTECTS THE LEAD AND INCREASES ITS RESISTANCE TO BREAKING.

LPS - LEAD PROTECTION SYSTEM: SYSTÈME D'ADHÉRENCE DE LA MINE AU BOIS, QUI PROTÈGE LA MINE ET AUGMENTE SA RÉSISTANCE À LA CASSE.



NAGYON ELLENÁLLÓ ÉS SIMA FA, KIVÁLÓAN LEHET HEGYEZNI.

VERY RESISTANT AND SMOOTH WOOD, ALLOWING SMOOTH SHARPENING.

BOIS TRÈS RÉSISTANT ET SOUPLE, CE QUI PERMET UNE TAILLE FACILE.



SIMÁBB CERUZABÉL, AMELY LEHETŐVÉ TESZI A MÉG EGYSÉGESEBB SZÍNEZÉST.

SMOOTHER LEAD, ALLOWING EVEN LINES WITH CONSISTENT COLOURS.

UNE MINE PLUS SOUPLE, QUI PERMET UN TRAIT UNIFORME ET DES COULEURS HOMOGÈNES.



MINŐSÉGI, TARTÓS ÉS BIZTONSÁGOS PIGMENTET HASZNÁLNAK. EZEK MEGFELELNEK AZ EN71-ES EURÓPAI BIZTONSÁGI SZABÁLYZATNAK ÉS AZ EGYESÜLT ÁLLAMOK ASTM RENDELETÉNEK.

QUALITY, SOLID AND SAFE PIGMENTS ARE USED. THEY COMPLY WITH EUROPEAN SAFETY REGULATION EN71 AND THE UNITED STATES ASTM REGULATION.

LES PIGMENTS UTILISÉS SONT DE QUALITÉ, SOLIDES ET INOFFENSIFS. ILS SONT CONFORMES AUX NORMES DE SÉCURITÉ EUROPÉENNE EN71 ET ÉTATSUNIENNE ASTM.

FÁBÓL KÉSZÜLT SZÍNES CERUZÁK · COLOUR PENCILS MADE OF WOOD
 CRAYONS DE COULEUR EN BOIS



2 PIROS-KÉK CERUZA
 2 BICOLOUR PENCILS
 2 CRAYONS BICOLORES

21 x 6,5 x 0,8 cm · 24 gr
 25 units · 0,85 kg

BWM10294
 8411574047193

PIROS-KÉK CERUZA
 BICOLOUR PENCILS
 CRAYONS BICOLORES

096

TOP SELLER

MAXI





KÉTVEGŰ CERUZÁK
 BICOLOUR PENCILS
 CRAYONS BICOLORES

12 CERUZA, 24 SZÍN
 12 PENCILS, 24 COLOURS
 12 CRAYONS, 24 COULEURS



11111

Mandarin

KÉTVEGŰ CERUZÁK
 BICOLOUR PENCILS
 CRAYONS BICOLORES

338

Graphite HB

MILAN®

GRAFIT CERUZA
 GRAPHITE PENCILS
 CRAYONS GRAPHITE

SZÖVEGKIEMLŐ CERUZA
 HIGHLIGHTER PENCILS
 CRAYONS POUR SURLIGNER



rendelési kód: F35172000



12 MAXI



rendelési kód: F35174000



12 MAXI



rendelési kód: F34190K12



12 MAXI

TOP SELLER



rendelési kód: F35175000



12 MAXI

TOP SELLER



Ø 2,9 mm

17,5 x 0,63 cm · 4,6 gr

12 unidades/cajita
 units/box
 unités/boîte

20,5 x 4,5 x 1 cm · 66 gr

12 units · 0,79 kg

96 units · 6,90 kg

0702312
 8411574042853



Ø 5 mm

17,5 x 1 cm · 10,1 gr

12 unidades/cajita
 units/box
 unités/boîte

20,6 x 6 x 2 cm · 132 gr

12 units · 1,63 kg

72 units · 9,80 kg

0702612
 8411574055884



Ø 2,9 mm

17,5 x 0,85 cm · 4,7 gr

12 unidades/cajita
 units/box
 unités/boîte

22 x 10 x 1 cm · 80 gr

12 units · 0,96 kg

96 units · 8,30 kg

07112312
 8411574072225



HB Ø 2,9 mm

17,5 x 0,63 cm · 4,6 gr

12 unidades/cajita
 units/box
 unités/boîte

20,5 x 4,5 x 1,5 cm · 66 gr

12 units · 0,80 kg

96 units · 6,80 kg

07323812
 8411574057796

FÁBÓL KÉSZÜLT SZÍNES CERUZÁK · COLOUR PENCILS MADE OF WOOD
CRAYONS DE COULEUR EN BOIS



KÉTVEGŰ CERUZA
BICOLOUR PENCILS
CRAYONS BICOLORES

Black Wood



FLUO SZÍNEK
HIGHLIGHTER PENCILS
CRAYONS POUR SURLIGNER

METÁL SZÍNES CERUZA
METALLIC PENCILS
CRAYONS MÉTALLISÉS



rendelési kód: F34190K06



17,5 x 0,85 cm · 5,2 gr

6 unidades/cajita
units/box
unités/boîte

21,8 x 4,4 x 0,8 cm · 44 gr

24 units · 1,10 kg

192 units · 9,20 kg

07123306



8411574080084



Black Wood



x6 FLUO SZÍN
HIGHLIGHTER
POUR SURLIGNER

rendelési kód: F34187K06



17,5 x 0,62 cm · 5,2 gr

6 unidades/cajita
units/box
unités/boîte

21,8 x 4,4 x 0,8 cm · 44 gr

24 units · 1,10 kg

192 units · 9,20 kg

0752306



8411574048787



Black Wood



x6 METÁL SZÍN
METALLIC
MÉTALLISÉS

rendelési kód: F34189K06



17,5 x 0,62 cm · 5,2 gr

6 unidades/cajita
units/box
unités/boîte

21,8 x 4,4 x 0,8 cm · 44 gr

24 units · 1,10 kg

192 units · 9,20 kg

07102306



8411574070702



VASTAG
CERUZABÉL

Black Wood



x6 SZÍNES CERUZA
COLOUR PENCILS
CRAYONS DE COULEUR

COPPER
SERIES

rendelési kód: F34194K06



17,5 x 0,73 cm · 4,6 gr

6 unidades/cajita
units/box
unités/boîte

21,8 x 4,4 x 0,8 cm · 44 gr

24 units · 0,99 kg

192 units · 9,20 kg

0713206



8411574082057

FÁBÓL KÉSZÜLT SZÍNES CERUZÁK · COLOUR PENCILS MADE OF WOOD
CRAYONS DE COULEUR EN BOIS



SPECIAL series



x6 SZÍNES CERUZA
COLOUR PENCILS
CRAYONS DE COULEUR

rendelési kód: F34192K06



17,4 x 0,62 cm · 4,7 gr

6 unidades/cajita
units/box
unités/boîte

21,8 x 4,4 x 0,8 cm · 38 gr

24 units · 0,99 kg

192 units · 8,40 kg

072331506SHP



8411574080107



SPECIAL series



x6 SZÍNES CERUZA
COLOUR PENCILS
CRAYONS DE COULEUR

rendelési kód: F34193K06



17,4 x 0,62 cm · 4,7 gr

6 unidades/cajita
units/box
unités/boîte

21,8 x 4,4 x 0,8 cm · 38 gr

24 units · 0,99 kg

192 units · 8,40 kg

072331506HB



8411574081661



VASTAG CERUZABÉL

Black Wood



x6 SZÍNES CERUZA
COLOUR PENCILS
CRAYONS DE COULEUR

rendelési kód: F34195K06



17,5 x 0,7 cm · 4,1 gr

6 unidades/cajita
units/box
unités/boîte

20,4 x 7,1 x 1 cm · 46 gr

24 units · 1,28 kg

144 units · 9,5 kg

071522206



8411574086369



Black Wood

MULTICOLOUR
MAXI
MULTICOLOUR

SUNSET
SERIES

rendelési kód: F35171SUN

TOP
SELLER



17,5 x 0,95 cm · 9,5 gr

12 unidades/cajita
units/box
unités/boîte

18 x 5,8 x 2 cm · 0,14 kg

12 units · 1,6 kg

48 units · 6,75 kg

0717251512SN



8411574097266



FÁBÓL KÉSZÜLT MAXI SZÍNES CERUZÁK · MAXI COLOUR PENCILS MADE OF WOOD · CRAYONS DE COULEUR MAXI EN BOIS



rendelési kód: F34197K12

MAXI



17,5 x 0,85 cm · 10,2 gr



NEW DESIGN!

12
u./cajita
u./box
u./boîte

21,5 x 17,5 x 1,5 cm · 0,16 kg

12 units · 2,05 kg

48 units · 9 kg

07226212FC



8411574087670



rendelési kód: F34174K12

TOP SELLER

MAXI



17,5 x 0,85 cm · 10,2 gr



NEW DESIGN!

12
u./cajita
u./box
u./boîte

21,3 x 17,2 x 1,5 cm · 0,16 kg

12 units · 1,96 kg

48 units · 8,50 kg

0722612



8411574017936



rendelési kód: F34173K12

MAXI



17,5 x 0,93 cm · 10,2 gr



NEW DESIGN!

12
u./cajita
u./box
u./boîte

21,3 x 17,2 x 1,5 cm · 0,16 kg

12 units · 2 kg

48 units · 8,30 kg

0722412



8411574017943



FÁBÓL KÉSZÜLT SZÍNES CERUZÁK · COLOUR PENCILS MADE OF WOOD
· CRAYONS DE COULEUR EN BOIS

TOP
SELLER



17,4 x 0,62 cm
4,5 gr

rendelési kód: F34172K12



12 unidades/cajita
units/box
unités/boîte

21 x 8,5 x 0,8 cm · 35 gr

24 units · 0,85 kg

96 units · 7,20 kg

0728312



8411574023807

rendelési kód: F34172K24



24 unidades/cajita
units/box
unités/boîte

21 x 19 x 1 cm · 0,16 kg

6 units · 0,96 kg

48 units · 8,40 kg

0728324

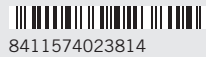

8411574023814

rendelési kód: F35171D01



288 u./cajita
u./box
u./boîte

36,5 x 33 x 4 cm · 2 kg

5 units · 11 kg

07271288



8411574023791

x24
CERUZA
SZÍNEKÉNT
PENCILS
PER COLOUR
CRAYONS
PAR COULEUR



x12
SZÍN
COLOURS
COULEURS

rendelési kód: F34175K12



HARD
CASE



PATENTED DESIGN

12

u./cajita
u./box
u./boîte

20 x 11,5 x 1 cm · 138 gr

6 units · 0,95 kg

96 units · 16,70 kg

0729312



8411574036555

rendelési kód: F34175K24



HARD
CASE



PATENTED DESIGN

24

u./cajita
u./box
u./boîte

22,4 x 20,6 x 1,3 cm · 0,29 kg

6 units · 1,95 kg

24 units · 8,20 kg

0729324



8411574027072

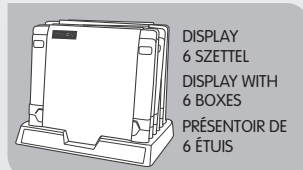

DISPLAY
6 SZETTEL
DISPLAY WITH
6 BOXES
PRÉSENTOIR DE
6 ÉTUIS



EGYSZÍNŰ

TOP
SELLER

12 unidades/cajita
units/box
unités/boîte

21 x 8,5 x 0,8 cm · 64 gr

12 units · 0,88 kg

96 units · 7 kg

0722312012
rendelési kód: F35171550

0722313412
rendelési kód: F35171650

0722315212
rendelési kód: F35171101

0722312212
rendelési kód: F35171950

0722314112
rendelési kód: F35171700

0722314912
rendelési kód: F35171100

0722313012
rendelési kód: F35171400

0722316112
rendelési kód: F35171300

0722317012
rendelési kód: F35171800

0722313212
rendelési kód: F35171600

0722316012
rendelési kód: F35171301

0722318012
rendelési kód: F35171200

FÁBÓL KÉSZÜLT SZÍNES CERUZÁK · COLOUR PENCILS MADE OF WOOD
 CRAYONS DE COULEUR EN BOIS



rendelési kód: F34172K24

NEW DESIGN!

24 unidades/cajita
 units/box
 unités/boîte

21 x 19 x 1 cm · 0,18 kg

6 unit · 0,98 kg

48 units · 8,10 kg

0722324

rendelési kód: F34172K18

NEW DESIGN!

18 unidades/cajita
 units/box
 unités/boîte

21,4 x 14,5 x 1 cm · 0,12 kg

12 units · 1,45 kg

72 units · 9,30 kg

0722318

rendelési kód: F34172K12

12 unidades/cajita
 units/box
 unités/boîte

21 x 9 x 1 cm · 74 gr

12 units · 0,91 kg

96 units · 7,60 kg

0722312

rendelési kód: F34188K06

6 unidades/cajita
 units/box
 unités/boîte

21 x 4,5 x 0,8 cm · 35 gr

24 units · 0,85 kg

192 units · 7,30 kg

0722306

**TOP
 SELLER**



17,4 x 0,62 cm
 4,5 gr

FÁBÓL KÉSZÜLT SZÍNES CERUZÁK · COLOUR PENCILS MADE OF WOOD
 CRAYONS DE COULEUR EN BOIS

TOP
SELLER



17,4 x 0,62 cm
5,1 gr

rendelési kód: F34171K24



NEW
DESIGN!

24 unidades/cajita
units/box
unités/boîte

21 x 19 x 1 cm · 0,16 kg

6 unit · 0,95 kg

48 units · 8,10 kg

80024



8411574800248

rendelési kód: F34171K18



NEW
DESIGN!

18 unidades/cajita
units/box
unités/boîte

21,4 x 14,5 x 1 cm · 0,12 kg

12 units · 1,45 kg

72 units · 9,30 kg

07221118



8411574071945

rendelési kód: F34171K12



NEW
DESIGN!

12 unidades/cajita
units/box
unités/boîte

21 x 8,5 x 0,8 cm · 74 gr

12 units · 0,91 kg

96 units · 7,60 kg

80012



8411574800125

rendelési kód: F34171K06



6 unidades/cajita
units/box
unités/boîte

21 x 4,5 x 0,8 cm · 35 gr

24 units · 0,85 kg

192 units · 7,30 kg

07221106



8411574071938



NEW
DESIGN!

rendelési kód: F34196K24



24 unidades/cajita
units/box
unités/boîte

21 x 19 x 1 cm · 0,17 kg

6 units · 0,95 kg

48 units · 7,60 kg

07221224FC



8411574087663

NEW
DESIGN!

rendelési kód: F34196K12



12 unidades/cajita
units/box
unités/boîte

21 x 8,5 x 0,8 cm · 74 gr

12 units · 0,85 kg

96 units · 7,30 kg

07221212FC



8411574087656



17,4 x 0,62 cm
4,5 gr

FÁBÓL KÉSZÜLT SZÍNES CERUZÁK VASTAG CERUZABÉLLEL · THICK LEAD COLOUR PENCILS MADE OF WOOD · CRAYONS DE COULEUR EN BOIS MINE ÉPAISSE

rendelési kód: F34181K12



12 unidades/cajita
units/box
unités/boîte

21 x 9 x 1 cm · 82 gr

12 units · 0,98 kg

96 units · 8,10 kg

0722112

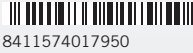

8411574017950

rendelési kód: F34181K24



24 unidades/cajita
units/box
unités/boîte

21 x 19 x 1 cm · 0,17 gr

6 units · 1 kg

48 units · 9,10 kg

0722124



8411574017967

VASTAG CERUZABÉL
THICK LEAD
MINE ÉPAISSE

FÉMDOBOZOS SZÍNES CERUZÁK · METAL BOXES · BOÎTES MÉTALLIQUES

METAL BOX
ART



rendelési kód: F34186K12



rendelési kód: F34186K24



rendelési kód: F34186K36

12
u./cajita
u./box
u./boîte

18,5 x 10,2 x 1,2 cm · 142 gr

12 units · 1,73 kg

72 units · 11 kg

80057



8411574800576

24
u./cajita
u./box
u./boîte

21,5 x 19 x 1,4 cm · 0,31 kg

6 units · 1,86 kg

36 units · 11,90 kg

80058



8411574800583

36
u./cajita
u./box
u./boîte

30,5 x 18,5 x 1,4 cm · 0,45 kg

4 units · 1,79 kg

24 units · 11,60 kg

0726136

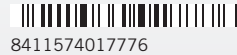

8411574017776

48
u./cajita
u./box
u./boîte

41,2 x 18,6 x 1,3 cm · 0,58 kg

18 units · 12 kg

0726148



8411574092377

2 METAL SZÍN



rendelési kód: F34186K48

FELAKASZTHATÓ KARTON KIEGÉSZÍTŐ · HANGING CARD BAND · BANDEAU D'ACCROCHE EN CARTON



22,8 x 13 x 1,5 cm · 0,24 kg

99491401



8411574057987

rendelési kód: MIL000048



3.5 mm

17,5 x 0,75 cm
4,8 gr



FÁBÓL KÉSZÜLT AKVARELL SZÍNES CERUZÁK · WATER SOLUBLE PENCILS MADE OF WOOD · CRAYONS EN BOIS AQUARELLABLES

VÍZBEN OLDÓDÓ
WATER SOLUBLE
AQUARELLABLES

1 ECSETTEL, 70% PÓNISZŐR + 30% SZINTETIKUS SZÁLAK

WITH 1 BRUSH, 70% PONY HAIR + 30% SYNTHETIC

AVEC 1 PINCEAU 70% PONEY DE CHÈVRE + 30% SYNTHÉTIQUES



rendelési kód: F34179K12

12 unidades/cajita
units/box
unités/boîte

21 x 9 x 0,8 cm · 76 gr

12 units · 0,93 kg

96 units · 7,70 kg

0742312



8411574028741



rendelési kód: F34179K24

24 unidades/cajita
units/box
unités/boîte

21,5 x 20 x 1 cm · 0,17 kg

6 units · 1,1 kg

48 units · 9,20 kg

0742324



8411574028758



ECSETEK
PG. 124
PG. 145



17,4 x 0,62 cm
4,8 gr

FÁBÓL KÉSZÜLT AKVARELL SZÍNES CERUZÁK
 THICK LEAD WATER SOLUBLE COLOUR PENCILS MADE OF WOOD
 CRAYONS DE COULEUR EN BOIS AQUARELLABLES MINE ÉPAISSE

VASTAG
 CERUZABÉL
 THICK LEAD
 MINE ÉPAISSE

VÍZBEN OLDÓDÓ
 WATER SOLUBLE
 AQUARELLABLES

rendelési kód: F34179K05



23 x 16 x 1,1 cm - 60 g
 12 units - 0,76 kg
 72 units - 5,20 kg

BWM10401
 8411574076186

1 ÚJRA TÖLTHETŐ ECSETTOLL + 5 AKVARELL SZÍNES CERUZA
 1 REFILLABLE BRUSH + 5 WATER SOLUBLE COLOUR PENCILS
 1 PINCEAU RECHARGEABLE + 5 CRAYONS DE COULEUR AQUARELLABLES



NÉZD MEG A VIDEÓT

ÚJRA TÖLTHETŐ ECSETTOLL AKVARELL MUNKÁKHOZ ÉS KORREKCIÓKHOZ. PG. 145 >
 REFILLABLE FOUNTAIN WATER BRUSH FOR WASHES AND SELF-CLEANING WITH WATER
 PINCEAU RECHARGEABLE POUR TECHNIQUES HUMIDES ET AUTO LAVABLE À L'EAU

Ø4 mm

M 13,5 x Ø1,7 cm

Water Brush



OPEN / OUVRIRE
 8 ml
 FILL / LLENAR / REMPLIR
 CLOSE / CERRAR / FERMER
 PAINT / PINTAR / PEINDRE

rendelési kód: F34179K36



36
 COLOURS

2 METAL COLOURS

ART

36 30 x 18,5 x 1,3 cm - 0,47 g
 u./cajita 4 units - 1,95 kg
 u./box 24 units - 11,60 kg

07167436
 8411574091776

1 ECSETTEL, 70% PÓNISZŐR + 30% SZINTETIKUS SZÁLAK
 WITH 1 BRUSH, 70% PONY HAIR + 30% SYNTHETIC
 AVEC 1 PINCEAU 70% PONEY DE CHÈVRE + 30% SYNTHÉTIQUES



MILAN® 103

FLAKASZTHATÓ KARTON KIEGÉSZÍTŐ · HANGING CARD BAND · BANDEAU D'ACCROCHE EN CARTON



rendelési kód: MIL000071

22,8 x 13 x 1,5 cm - 0,24 kg

994907167436
 8411574093930



rendelési kód: MIL000071

22,8 x 13 x 1,5 cm - 0,24 kg

994907167436
 8411574093930

17,4 x 0,75 cm
 4,8 gr

Ø3.5 mm



FAMENTES GRAFIT- ÉS SZÍNES CERUZÁK · WOODLESS GRAPHITE AND COLOUR PENCILS · CRAYONS GRAPHITE ET DE COULEUR SANS BOIS

VÍZZEL OLDÓDIK
WATER SOLUBLE
AQUARELLABLES

HB



4B



8B



MILAN®

TODOGRAPHITE 4B

181

ART

Ø 6 mm

14,6 x 0,6 cm
10,6 gr



HASZNÁLATI JAVASLATOK · INDICATIONS FOR USE · INDICATIONS D'UTILISATION



rendelési kód: F33180K03

METAL BOX

19 x 11,3 x 1 cm · 0,17 kg

12 units · 2,28 kg

48 units · 9,12 kg

07168103C



8411574095132

3 CERUZA (HB, 4B, 8B),
1 ECSET, 1 RADÍR,
1 HEGYEZŐ

3 TODOGRAPHITE
(HB, 4B, 8B), 1 BRUSH,
1 ERASER, 1 SHARPENER

3 TODOGRAPHITE (HB, 4B,
8B), 1 PINCEAU, 1 GOMME,
1 TAILLE-CRAYONS

FESTÉS ÉS AKVARELL
HASZNÁLAT
PAINTING AND WATER
COLOUR PAINTING.
PEINDRE ET AQUARELLER.



VEGYEN PIGMENTET A
CERUZÁRÓL EGY ECSET
MOZDULATTAL.

TAKE THE PIGMENT FROM
THE PENCIL WITH A DAMP
PAINTBRUSH.
PRENDRE LE PIGMENT DU
CRAYON AVEC LE PINCEAU
HUMIDE.



NEDVESÍTSE BE
A CERUZÁT ÉS
FESSEN

WET THE PENCIL AND
PAINT.
MOUILLER LE CRAYON
ET PEINDRE.



NEDVESÍTSE BE A
CERUZA FORGÁCSOT
ÉS FESSEN EGY
ECSETTEL.

WET THE LEAD DUST
WITH A PAINTBRUSH AND
PAINT.
MOUILLER LA POUDRE DE
MINE AVEC LE PINCEAU ET
PEINDRE.



FAMENTES GRAFIT- ÉS SZÍNES CERUZÁK · WOODLESS GRAPHITE AND COLOUR PENCILS · CRAYONS GRAPHITE ET DE COULEUR SANS BOIS

VÍZZEL OLDÓDIK
WATER SOLUBLE
AQUARELLABLES



SZÍNKEVERÉSI SEGÉDLET ÉS TIPPEK · COLOUR MIXING GUIDE AND TIPS · GUIDE CHROMATIQUE ET INDICATIONS



rendelési kód: F34198K12



rendelési kód: F34198K24

12 unidades/cajita
units/box
unités/boîte

19 x 11,3 x 1 cm · 0,22 kg

12 units · 2,88 kg

48 units · 11,52 kg

07468112C



8411574095125

12 CERUZA, 1 ECSET
12 TODOCOLOR, 1 BRUSH
12 TODOCOLOR, 1 PINCEAU



METAL BOX

2 METAL COLOURS

24 unidades/cajita
units/box
unités/boîte

21 x 18,5 x 1,5 cm · 0,42 kg

6 units · 2,90 kg

24 units · 11,50 kg

07468124C



8411574099376

24 CERUZA, 1 ECSET
24 TODOCOLOR, 1 BRUSH
24 TODOCOLOR, 1 PINCEAU



METAL BOX

2 METAL COLOURS



∅ 6 mm

ART

14,6 x 0,6 cm
9,8 gr

HÁROMSZÖGLETŰ SZÍNES ZSÍRKRÁTÉK · TRIANGULAR PLASTIC COLOUR PENCILS · CRAYONS DE COULEUR EN PLASTIQUE TRIANGULAIRES



Plastipastel  12 x 0,8 cm · 5,5 gr

A polietilén zsírkkréták nem koszolódnak és ellenállóak, ezért ideális választás gyermekeknek. kialakításának köszönhetően vékony vonalakat rajzolhatunk a hegygel, vastagabbakat annak szélével, és nagy felületeket színezhetünk annak testével.

Injected polyethylene plastic coloured pencils, clean and resistant, ideal for children. Allow fine lines to be drawn with the tip, thick lines to be drawn with the rear section, and large areas to be coloured with their full length.

Crayons de couleur à base de plastique en polyéthylène injecté, propres et résistants, idéaux pour les plus petits. Ils permettent de dessiner des traits fins avec la pointe, épais avec la partie postérieure et de colorier de grandes zones avec toute la longueur.

A háromszög test a lekerekített hegygel a legmegfelelőbb a gyermekek számára, megelezőve, hogy a zsírkréta lecsússzon a munka felületről.

It's triangular design with rounded edges adapts to the hands of pupils and prevents the pencil rolling off the work surface.

Leur design triangulaire avec des arêtes arrondies s'adapte aux mains des écoliers et empêche le crayon de rouler sur la surface de travail.



rendelési kód: M04173K12

2 fluo SZÍN

AJÁNDÉK RADÍRRAL ÉS HEGYZŐVEL

WITH AN ERASER AND A SHARPENER
AVEC UNE GOMME ET UN TAILLE-CRAYONS

12 unidades/cajita
units/box
unités/boîte

27,7 x 16,2 x 1 cm · 111 gr

12 units · 1,55 kg

96 units · 12,70 kg

027212K



8411574077749



rendelési kód: M04176K06

6

15,5 x 6 x 1 cm · 36 gr

30 units · 1,42 kg

120 units · 5,7 kg

022T06



8411574088790



rendelési kód: M04176K12

12

15,5 x 11 x 1 cm · 78 gr

20 units · 1,82 kg

80 units · 7 kg

022T12



8411574088806



rendelési kód: M04176K24

24

20 x 15,5 x 1 cm · 0,15 kg

12 units · 2 kg

48 units · 8,3 kg

022T24



8411574088813

HENGERES SZÍNES ZSÍRKRÉTA · ROUND PLASTIC COLOUR PENCILS
CRAYONS DE COULEUR EN PLASTIQUE RONDS



ZSÍRKRÉTA  11,5 x 0,75 cm · 5,5 gr



6
u./cajita
u./box
u./boîte

15,5 x 6 x 1 cm · 36 gr
30 units · 1,42 kg
120 units · 5,7 kg

022R06

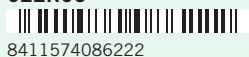

8411574086222



12
u./cajita
u./box
u./boîte

15,5 x 11 x 1 cm · 78 gr
20 units · 1,82 kg
80 units · 7 kg

022R12

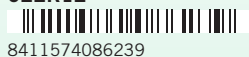

8411574086239



24
u./cajita
u./box
u./boîte

20 x 15,5 x 1 cm · 0,15 kg
12 units · 2 kg
48 units · 8,3 kg

022R24

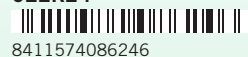

8411574086246



30
u./cajita
u./box
u./boîte

31 x 18 x 1 cm · 0,23 kg
6 units · 1,5 kg
24 units · 6,4 kg

022R30



8411574086253



MAXI HÁROMSZÖG SZÍNES ZSÍRKRÉTA · MAXI PLASTIC COLOUR PENCILS
CRAYONS DE COULEUR EN PLASTIQUE MAXI



ZSÍRKRÉTA  **MAXI**
10 x 1 cm · 9 gr



12
u./cajita
u./box
u./boîte

13,5 x 12,5 x 1,2 cm · 13 gr
20 units · 2,70 kg
80 units · 11 kg

022XT12

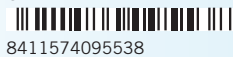

8411574095538



rendelési kód: M04177K12



MAXI



MAXI MAGIC



VÍZZEL MOSHATÓ MAXI



KÉTÉVGŰ MAXI



KÉTÉVGŰ



TEXTIL



PASTEL
SÓRÓ



RADÍROZHATÓ



ECSET VÉG



ECSET VÉG METAL

KÖNNYEDÉN TÖRÖLHETŐ



KÖNNYEDÉN TÖRÖLHETŐ



ALKOHOLOS MARKER



ALKOHOLOS MARKER



ALKOHOLOS MARKER



SZÁRAZON TÖRÖLHETŐ



SZÁRAZON TÖRÖLHETŐ



SZÁRAZON TÖRÖLHETŐ





ECSET
VÉG
FLUO



ECSET
VÉG
VÍZFESTÉK



KÉTVÉGŰ



HÁROMSZÖG
TEST



FINE
LINER
sway



FINE
LINER
sway



FLUO
JUNIOR



PASZTELL
MARKER
sway



FLUO
MARKER



MILAN®

FILCTOLLAK
MARKERS
FEUTRES

A MILAN filcek gyerekek, fiatalok és felnőttek számára lettek tervezve, széles körű formakivitelben, hogy minden felhasználó megtalálja az igényeinek legmegfelelőbbet.

A festék az élénk színei mellett megfelel az EN71-es európai szabályzásnak, illetve az Egyesült Államok ATSM előírásainak. Ezenfelül a MILAN filcek ellenálló hegygel rendelkeznek, amelyek magas nyomásra lettek tesztelve, hogy az idők során megtartsák alakjukat és vonalaikat.

MILAN markers are designed for children, young people and adults, with shapes and types of tips adapted to the preferences of each user. The colours are bright, and the ink used complies with European regulation EN71 and the United States ASTM regulation. Furthermore, MILAN markers have a resistant tip, tested against drops and strong pressure, maintaining its shape and lines over time.

Les feutres MILAN sont destinés aux plus petits, aux jeunes et même aux adultes puisque leur forme et leur type de pointe s'adaptent aux préférences de chaque utilisateur. Leurs couleurs sont lumineuses et l'encre utilisée est conforme aux normes européenne EN71 et étatsunienne ASTM. De plus, les feutres MILAN bénéficient d'une pointe résistante aux chutes et aux fortes pressions, conservant leur forme et leur tracé malgré le temps qui passe.



STRAPABÍRÓ FILCTOLL HEGY
NON-DEFORMABLE TIP
POINTE INDÉFORMABLE

MAXI SZÍNES FILCTOLLAK · MAXI FIBREPENS · FEUTRES MAXI

TOP
SELLER



Ø 7.5
mm

MAXI 13,5 x 1,43 cm · 11,6 gr WATER-BASED INK

rendelési kód: F21173K12



12 unidades/cajita
units/box
unités/boîte

18,5 x 17 x 1,7 cm · 0,18 kg

12 units · 2,25 kg

48 units · 9 kg

80020



8411574800200

rendelési kód: F21175K10



Ø 7.5
mm

MAXI MAGIC 13,5 x 1,43 cm · 12,1 gr WATER-BASED INK



10 unidades/cajita
units/box
unités/boîte

17 x 15,6 x 1,7 cm · 140 gr

12 units · 1,70 kg

72 units · 11,20 kg

80023



8411574800231

NEW
DESIGN!

MAXI
MAGIC
8+2



VÁLTOZTASS SZÍNEKET A
"VARÁZS" TOLLAL!
CHANGING COLORS
WITH MAGIC PEN
CHANGEMENT
DE COULEURS AVEC
FEUTRE MAGIQUE

MOSHATÓ MAXI SZÍNES FILCTOLL · MAXI FIBREPENS SUPERWASHABLES ·
FEUTRES MAXI SUPERLAVABLES

rendelési kód: F21176K12



Ø 7.5
mm

MAXI SUPER washable 13,5 x 1,43 cm · 11,8 gr WATER-BASED INK



12 unidades/cajita
units/box
unités/boîte

18,5 x 17 x 1,7 cm · 0,18 kg

12 units · 2,10 kg

48 units · 9 kg

0692412



8411574076933

MOSHATÓ

KÉTVÉGŰ MAXI SZÍNES FILCTOLL · MAXI FIBREPENS BICOLOUR · FEUTRES MAXI BICOLORES



CONICAL TIP
PUNTA CONICA

Ø 7.5 mm

MAXI BICOLOR 17 x 1,43 cm · 15,7 gr WATER-BASED INK

rendelési kód: F21176K08

8 unidades/cajita
units/box
unités/boîte

21 x 12,5 x 1,7 cm · 150 gr

12 units · 1,85 kg

72 units · 11,80 kg

80090

8411574800903

8 ROTULADORES
FIBREPENS
16
COLORES
COLOURS

Little Ones

KÉTVÉGŰ SZÍNES FILCTOLL · BICOLOUR FIBREPENS · FEUTRES BICOLORES



CONICAL TIP
PUNTA CONICA

Ø 5 mm

BICOLOR 13,5 x 1,04 cm · 8,7 gr WATER-BASED INK

rendelési kód: F21176K10

10 unidades/cajita
units/box
unités/boîte

20 x 11,5 x 1,2 cm · 98 gr

12 units · 1,29 kg

96 units · 11,10 kg

06171010

8411574021285

24 unidades/cajita
units/box
unités/boîte

20 x 14,5 x 2,5 cm · 0,21 kg

6 units · 1,30 kg

48 units · 11,00 kg

06121024

8411574102649

24 ROTULADORES
FIBREPENS
48
COLORES
COLOURS

rendelési kód: F21176K24

TEXTILFILCEK · FIBREPENS FOR FABRIC · FEUTRES TEXTILE



CONICAL TIP
PUNTA CONICA

Ø 4 mm

textile 16,5 x 1,07 cm · 6,9 gr

rendelési kód: F27171K06

6 unidades/cajita
units/box
unités/boîte

19,3 x 9,4 x 1,4 cm · 70 gr

12 units · 0,87 kg

144 units · 11 kg

06P6T

8411574000778

FILCTOLLAK TEXTIL DEKORÁLÁSÁHOZ · FIBREPENS FOR PAINTING ON FABRICS
FEUTRES TEXTILE POUR DESSINER SUR TISSU

- CARTON → in
- CAT
- TAO reverse



SZÍNES FILCTOLLAK · FIBREPENS · FEUTRES



CONIC 16,5 x 1,04 cm · 7,7 gr WATER-BASED INK



rendelési kód: F21178005

5
u./cajita
u./box
u./boîte

20 x 6 x 1 cm · 50 gr
20 units · 1,12 kg
240 units · 13,6 kg

0612305
8411574009276



rendelési kód: F21172K12

12
u./cajita
u./box
u./boîte

20 x 14,5 x 1 cm · 118 gr
12 units · 1,45 kg
72 units · 9,30 kg

0612312
8411574008347



rendelési kód: F21178018

18
u./cajita
u./box
u./boîte

27,4 x 19,3 x 1,4 cm · 0,2 kg
6 units · 1,21 kg
72 units · 15,80 kg

80092
8411574800927



rendelési kód: F21172K24

24
u./cajita
u./box
u./boîte

20,2 x 14,6 x 2,4 cm · 0,22 kg
6 units · 1,40 kg
48 units · 11,30 kg

0612324
8411574008354



FLEXIBILIS CSOMAGOLÁS
FLEXIBLE CASE · ÉTUI FLEXIBLE

HARD CASE KEMÉNY MŰANYAG DOBOZOS KIVTEL
HARD PENCIL CASES · ÉTUIS RIGIDES

NEW DESIGN!



rendelési kód: F21178K50

50
u./cajita
u./box
u./boîte

31 x 21,2 x 2,5 cm · 0,49 kg
6 units · 3,14 kg
24 units · 13,50 kg

06CT50
8411574000389



rendelési kód: F21172K50

6
u./cajita
u./box
u./boîte

15,5 x 6 x 1 cm · 36 gr
120 units · 5,7 kg

0615350
8411574020509



rendelési kód: MILO00118

6
u./cajita
u./box
u./boîte

15,5 x 6 x 1 cm · 36 gr
120 units · 5,7 kg

0615350Y
8411574049173

PASZTELL SZÍNES FILCTOLL · FIBREPENS · FEUTRES



CONIC pastel 16,5 x 1,04 cm · 7,7 gr WATER-BASED INK

rendelési kód: F211790K8

8 u./cajita u./box u./boite

19 x 9,1 x 1,3 cm · 0,80 kg
12 units · 1,26 kg
72 units · 7,5 kg

0612308P

8411574106128

PASTEL COLOURS



NEW!



TÖRÖLHETŐ SZÍNES FILCTOLLAK · ERASABLE FIBREPENS · FEUTRES EFFAÇABLES



erasable 16,5 x 1,07 cm · 6,9 gr

rendelési kód: F21175K12

TÖRÖLD A NEM KÍVÁNT VONALAKAT ÉS JAVÍTSD A HIBÁTI! A FEHÉRREL RAJZOLJ A SZÍNES HÁTTEREKRE!

ERASE UNWANTED STROKES AND CORRECT MISTAKES. WHITE PAINTING ON A COLOURED BACKGROUND.

EFFACE LES TRAITS NON DÉSIRES ET CORRIGE LES ERREURS. PEINT EN BLANC SUR UN FOND COLORÉ.



11+1 TÖRÖLHETŐ ERASABLE

12 unidades/cajita units/box unités/boite

20 x 14,5 x 1,3 cm · 122 gr
12 units · 1,47 kg
96 units · 12,50 kg

80093

8411574800934



ECSETFILCEK · BRUSH-TIP FIBREPENS · FEUTRES POINTE PINCEAU

FLEXIBILIS
ECSET
HEGY



0.5mm
min.

4mm
max.

Brush 15,8 x 1,00 cm · 6,8 gr WATER-BASED INK



rendelési kód: F21180K10

10 unidades/cajita
units/box
unités/boîte

19 x 12 x 1 cm · 98 gr

12 units · 1,18 kg

72 units · 7,60 kg

0612610



8411574056072



rendelési kód: F21180K24

24 unidades/cajita
units/box
unités/boîte

19,5 x 14 x 2 cm · 0,21 kg

6 units · 1,30 kg

48 units · 11,20 kg

0612624



8411574087632

FLEXIBILIS
ECSET
HEGY



0.5mm
min.

6mm
max.

Brush metal 15,6 x 1,00 cm · 7,5 gr WATER-BASED INK

METAL
SZÍNEK

rendelési kód: F2118MK06



6 unidades/cajita
units/box
unités/boîte

16,7 x 13,5 x 1,5 cm · 73 gr

12 units · 0,88 kg

144 units · 11,50 kg

0612606MET



8411574092780

6 METÁL SZÍN
6 METALLIC COLOURS
6 COULEURS MÉTALLISÉES



FLEXIBILIS
ECSET
HEGY



0.5mm
min.

6mm
max.

Brush fluo 15,6 x 1,00 cm · 7,5 gr WATER-BASED INK

FLUO
SZÍNEK

rendelési kód: F2118FK06



6 unidades/cajita
units/box
unités/boîte

16,7 x 13,5 x 1,5 cm · 73 gr

12 units · 0,88 kg

144 units · 11,50 kg

0612606FL



8411574092773

6 FLUO SZÍN
6 FLUORESCENT COLOURS
6 COULEURS FLUORESCENTES



ECSETFILCTOLL VÍZFESTÉKKEL · BRUSH TIP FIBREPEN WITH WATERCOLOR INK · FEUTRE
POINTE PINCEAU ET ENCRE AQUARELLE



rendelési kód: F21180K12



0.5mm
min.

6mm
max.

WATER
COLOUR

Brush

15,3 x 1,00 cm · 9,2 gr

WATER-BASED INK



12 unidades/cajita
units/box
unités/boîte

18,9 x 15,5 x 1,5 cm · 137 gr

12 units · 1,68 kg

72 units · 10 kg

0612612S



8411574104353



KÉTVÉGŰ SZÍNES FILCTOLL · DUAL TIP FIBREPENS · FEUTRES DOUBLE POINTE



ECSET HEGY



0.5mm
min.

4mm
max.

DUAL TIP

16,5 x 1,00 cm · 8,6 gr

WATER-BASED INK

5
mm



VÉKONY HEGY

FELAKASZTHATÓ
KARTON KIEGÉSZÍTŐ ·
HANGING CARD BAND ·
BANDEAU D'ACCROCHE
EN CARTON

rendelési kód: MIL000049



22,8 x 13 x 1,5 cm · 0,24 kg

99492201



8411574096948



METAL
BOX

SZÍNKEVERÉS SEGÉDLET ÉS
HASZNÁLATI TIPPEK

COLOUR MIXING GUIDE AND
STROKE TIPS

GUIDE CHROMATIQUE ET
INDICATIONS DES TYPES DE TRAITS

rendelési kód: F21178K12



12

19,7 x 18,5 x 1,5 cm · 0,28 kg

12 units · 3,5 kg

24 units · 7 kg

METAL
BOX

06161612



8411574094036

NÉZD MEG A
VIDEÓT!



rendelési kód: MIL000142



24

36,5 x 18,5 x 1,5 cm · 0,54 kg

10 units · 5,60 kg

20 units · 12,10 kg

METAL
BOX

06161624



8411574095804

VÉKONY HEGYŰ SZÍNES FILCTOLLAK · FINE-TIP FIBREPENS · FEUTRES POINTE FINE



15,3 x 0,8 cm · 5,5 gr WATER-BASED INK



rendelési kód: F21177K06

6
18,8 x 6,4 x 1,2 cm · 42 gr
u./cajita 24 units · 1,10 kg
u./box 240 units · 11 kg

06F6
8411574047742



rendelési kód: F21177K12

12
18,8 x 12,5 x 1,2 cm · 91 gr
u./cajita 12 units · 1,07 kg
u./box 144 units · 13,70 kg

06F12
8411574000754



rendelési kód: F21177K18

18
20,5 x 19,5 x 1,2 cm · 0,14 kg
u./cajita 12 units · 1,75 kg
u./box 72 units · 11,30 kg

06F18
8411574047759



rendelési kód: F21177K24

24
18,8 x 12,5 x 2 cm · 0,15 kg
u./cajita 6 units · 1,10 kg
u./box 48 units · 8,30 kg

06F24
8411574000761



fine 16,5 x 1,04 cm · 7,8 gr WATER-BASED INK



rendelési kód: F21171K12



12 unidades/cajita
units/box
unités/boîte
20 x 14,5 x 1 cm · 120 gr
12 units · 1,46 kg
72 units · 9,60 kg

80158
8411574801580



24 unidades/cajita
units/box
unités/boîte
20 x 14,5 x 2,5 cm · 0,22 kg
6 units · 1,32kg
48 units · 11,30 kg

80159
rendelési kód: F21171K24

FLEXIBILIS CSOMAGOLÁS
FLEXIBLE CASE



30 unidades/cajita
units/box
unités/boîte
19,5 x 19 x 2 cm · 0,29 kg
12 units · 3,70 kg
24 units · 8,30 kg

06CT30
rendelési kód: F21178K30



fine 16,5 x 1,04 cm · 8,4 gr WATER-BASED INK

rendelési kód: F21174K12

HÁROMSZÖG TEST



12 unidades/cajita
units/box
unités/boîte
19,5 x 14 x 1 cm · 126 gr
12 units · 1,65 kg
72 units · 9,60 kg

06121212
8411574031970

VÉKONY HEGYŰ FILCTOLLAK · FINE-TIP FIBREPENS · FEUTRES POINTE FINE



0.4 mm

fineLINER sway PACKS PATENTED DESIGN 16,5 x 1,04 cm · 7,7 gr WATER-BASED INK



EGYSZÍNŰ

16 unidades/cajita
units/box
unités/boîte

15,5 x 5,8 x 3,5 cm · 123 gr

42 units · 5,74 kg

84 units · 11,87 kg

0610041619

rendelési kód: F21181550

0610041632

rendelési kód: F21181600

0610041630

rendelési kód: F21181400

0610041660

rendelési kód: F21181301

0610041662

rendelési kód: F21181300

0610041651

rendelési kód: F21181100

0610041680

rendelési kód: F21181200



0.4 mm

fineLINER sway PACKS PATENTED DESIGN 16,5 x 1,04 cm · 7,7 gr WATER-BASED INK

rendelési kód: F21181P14



14 SZETT
5 PASZTELL FINELINER
FILCTOLL

14 CASES WITH
5 FINE-TIP FIBREPENS

14 ÉTUIS DE
5 FEUTRES POINTE FINE



DISPLAY KIHELYEZÉS



14 unidades/cajita
units/box
unités/boîte

15,6 x 11,3 x 9,4 cm · 0,68 kg

72 units · 9,60 kg

06180414PS

8411574085973

ÁTTETSŐ
ÖNTAPADÓ
JEGYZETŐMB
PG. 197

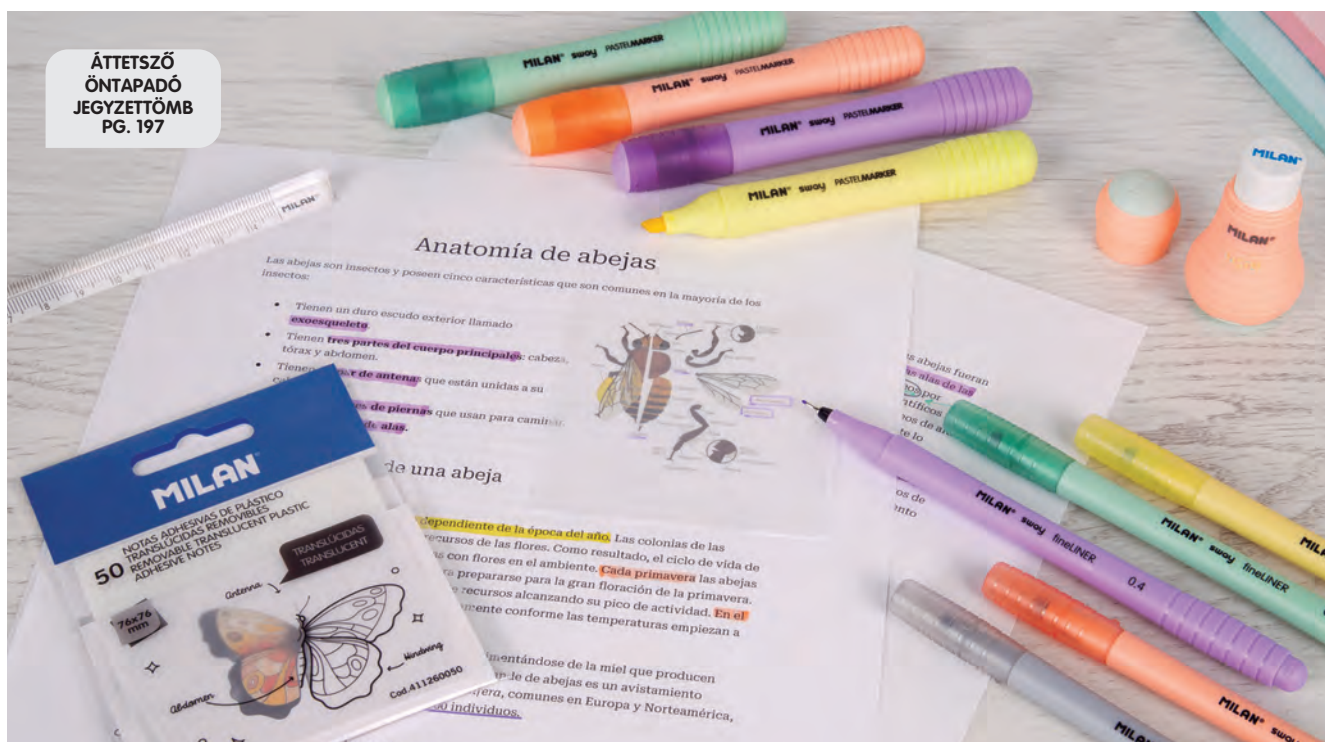

SZÖVEGKIEMELŐ FILCEK · FLUORESCENT MARKERS · SURLIGNEURS FLUORESCENTS



PASTELMARKER
sway PACKS

PATENTED DESIGN

12,4 x 1,7 x 1,5 cm · 12,3 gr WATER-BASED INK

PASTEL
SERIES

rendelési kód: MIL000055

7 unidades/cajita
units/box
unités/boîte

13,8 x 12,7 x 7,4 cm · 0,47 kg

18 units · 8,90 kg

162119807



8411574080428

7 SZETT 4 FLUO SZÖVEGKIEMELŐ FILCCSEL
7 CASES WITH 4 FLUORESCENT MARKERS
7 ÉTUIS DE 4 SURLIGNEURS FLUORESCENTS



rendelési kód: MIL000021

rendelési kód: MIL000019

rendelési kód: MIL000014

rendelési kód: MIL000015

rendelési kód: MIL000013



FLUO 10,7 x 2,6 x 2 cm · 16,1 gr WATER-BASED INK



BWM10428



rendelési kód: MIL000137

BWM10033



rendelési kód: MIL000590

21 x 8,2 x 2,1 cm · 66 gr

25 units · 2,10 kg



4 unidades/cajita
units/box
unités/boîte

14 x 12,5 x 2 cm · 78 gr

24 units · 2,05 kg

96 units · 8,80 kg

1687804



rendelési kód: MIL000035



80036



8411574800361

80037



8411574800378

80038



8411574800385

80039



8411574800392

80051



8411574800514

12 unidades/cajita
units/box
unités/boîte

15,3 x 10,5 x 3,7 cm · 0,22 kg

36 units · 8,70kg



FLUOJUNIOR 15,5 cm · Ø 1 cm · 7,6 gr WATER-BASED INK



22 unidades/cajita
units/box
unités/boîte

16,2 x 6,5 x 5 cm · 0,19 kg

45 units · 9,10 kg

16828225



rendelési kód: MIL000043

16828227



rendelési kód: MIL000045

16828226



rendelési kód: MIL000044

16828224



rendelési kód: MIL000042

TÖRÖLHETŐ FLUO MARKEREK · ERASABLE MARKERS · FEUTRES EFFAÇABLES

KÖNNYEN
ELTÁVOLÍTHATÓ

TOP
SELLER



FLUOGLASS PATENTED DESIGN 13,5 x Ø 1,7 cm · 21,3 gr WATER-BASED INK

MADE IN JAPAN

| | | | | | | |
|--|--|--------------------------|--|--|--------------------------|---|
| | | 591291012 | | | 591293012 | 12 unidades/cajita units/box unités/boîte |
| | | rendelési kód: F22065500 | | | rendelési kód: F22065400 | |
| | | 591292012 | | | 591293412 | 36 units · 10,7 kg |
| | | rendelési kód: F22065550 | | | rendelési kód: F22065650 | |
| | | 591293212 | | | 591295212 | 591296012 |
| | | rendelési kód: F22065600 | | | rendelési kód: F22065100 | |
| | | BWM10385 | | | BWM10391 | |
| | | rendelési kód: MIL000666 | | | rendelési kód: MIL000682 | |



ALKALMAS ÜVEG- ÉS MÁS
VIZÁLLÓ FELÜLETEKRE
KÖNNYEDÉN TÖRÖLHETŐ

TO WRITE ON GLASS AND
WATERPROOF SURFACES. EASY
TO REMOVE

POUR ÉCRIRE SUR LES VITRES ET
LES SURFACES IMPERMÉABLES.
FACILEMENT EFFAÇABLE

| | | | | | |
|--|--|--------------------------|--|--|---------------------------|
| | | BWM10386 | | | BWM10390 |
| | | rendelési kód: MIL000668 | | | rendelési kód: MIL000680 |
| | | BWM10388 | | | BWM10389 |
| | | rendelési kód: MIL000678 | | | rendelési kód: MIL000679 |
| | | BWM10387 | | | 21 x 8,2 x 2,2 cm · 30 gr |
| | | rendelési kód: MIL000670 | | | 24 units · 0,90 kg |



21 x 8,2 x 2,2 cm · 50 gr
25 units · 1,55 kg
BWM10277
rendelési kód: MIL000595

KÖNNYEN
ELTÁVOLÍTHATÓ



FLUOGLASS PATENTED DESIGN 14,9 x Ø 2,75 cm · 74,5 gr WATER-BASED INK

MADE IN JAPAN



rendelési kód: F22066500

| | | |
|--|-----------------------------------|-----------------------------|
| | 6 u./cajita u./box u./boîte | 16 x 8,5 x 5,5 cm · 0,47 kg |
| | 20 units · 10,20 kg | |
| | 591211006 | |
| | 8411574064664 | |

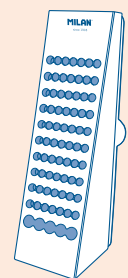

EXPOSITORES
DISPLAYS
PRÉSENTOIR
PG. 240 >



ALKOHOLOS FILCTOLLAK · PERMANENT MARKERS · MARQUEURS PERMANENTS



fine

PATENTED DESIGN

rendelési kód: F26004200
14,2 x 1,6 x 1,2 cm · 9,2 gr ALCOHOL-BASED INK

VÉKONY HEGY
FINE TIP
POINTE FINE

10

u./cajita
u./box
u./boîte

14,5 x 7 x 3 cm · 106 gr

144 units · 16,30 kg

16921122



8411574017813



TOP
SELLER



14,7 x 1,7 x 1,7 cm · 17,1 gr ALCOHOL-BASED INK



12

unidades/cajita
units/box
unités/boîte

15,3 x 10,8 x 3,5 cm · 0,23 kg

36 units · 8,70 kg

16429121

16429122

16429123

16429124

rendelési kód: F23171100

rendelési kód: F23171200

rendelési kód: F23171400

rendelési kód: F23171300



TOP
SELLER



14,7 x 1,7 x 1,7 cm · 17,1 gr ALCOHOL-BASED INK



12

unidades/cajita
units/box
unités/boîte

15,3 x 10,8 x 3,5 cm · 0,23 kg

36 units · 8,70 kg

16428121

16428122

16428123

rendelési kód: F23172100

rendelési kód: F23172200

rendelési kód: F23172400



TÁBLAÍRÓ FILCTOLLAK · WHITEBOARD MARKERS MARQUEURS
POUR TABLEAU BLANC

TOP SELLER

BULLET TIP
PUNTA REDONDA

Ø 3.7 mm

13,3 x 1,2 x 1,2 cm · 8 gr ALCOHOL-BASED INK



MILAN® WHITEBOARDMARKER

SZÁRAZON TÖRÖLHETŐ

12 unidades/cajita
units/box
unités/boîte

14 x 7 x 2,5 cm · 109 gr

144 units · 16,90 kg

16589121
rendelési kód: F22173100

16589122
rendelési kód: F22173200

16589123
rendelési kód: F22173400

16589124
rendelési kód: F22173300

NEW DESIGN!



TOP SELLER



MÁGNESES TÁBLATÖRLŐ SZIVACS
ERASER-CONTAINER WITH MAGNETIC
ATTACHMENT BOÎTE-EFFACEUR AVEC SUPPORT
MAGNÉTIQUE

15 X 3,7 x 3,7 cm

4 TÁBLAÍRÓ FILCTOLL
4 WHITEBOARD MARKERS
4 MARQUEURS POUR TABLEAU BLANC

TARTSA VÍZSZINTES POZÍCIÓBAN!
KEEP IN HORIZONTAL POSITION
MAINTENIR EN POSITION HORIZONTALE

rendelési kód: F22173K04



15,3 x 3,9 x 3,9 cm · 107 gr

12 units · 1,33 kg

72 units · 8,40 kg

165894
8411574031581

rendelési kód: F22173BL1



21 x 8,2 x 3,8 cm · 100 gr

12 units · 1,45 kg

BWM10402
8411574077961

TOP SELLER

BULLET TIP
PUNTA REDONDA

Ø 4.7 mm

14,7 x 1,7 x 1,7 cm · 15,8 gr ALCOHOL-BASED INK



MILAN® Rotulador para pizarra blanca
WhiteBoard Marker

SZÁRAZON TÖRÖLHETŐ

12 unidades/cajita
units/box
unités/boîte

15,3 x 10,8 x 3,5 cm · 0,21 kg

36 units · 8,30 kg

16529121
rendelési kód: F22171100

16529122
rendelési kód: F22171200

16529123
rendelési kód: F22171400

16529124
rendelési kód: F22171300



TOP SELLER

CHISEL TIP
PUNTA BISELADA

1 mm 4 mm

14,7 x 1,7 x 1,7 cm · 16,5 gr ALCOHOL-BASED INK



MILAN® Rotulador para pizarra blanca
WhiteBoard Marker

SZÁRAZON TÖRÖLHETŐ

12 unidades/cajita
units/box
unités/boîte

15,3 x 10,8 x 3,5 cm · 0,21 kg

36 units · 8,4 kg

16528121
rendelési kód: F22172100

16528122
rendelési kód: F22172200

16528123
rendelési kód: F22172400



PORMENTES KRÉTÁK · CHALKS WITH ADHERENT STROKE · CRAIES AVEC TRACÉ ADHÉRENT

KALCIUM-SZULFÁT
CALCIUM SULPHATE
SULFATE DE CALCIUM

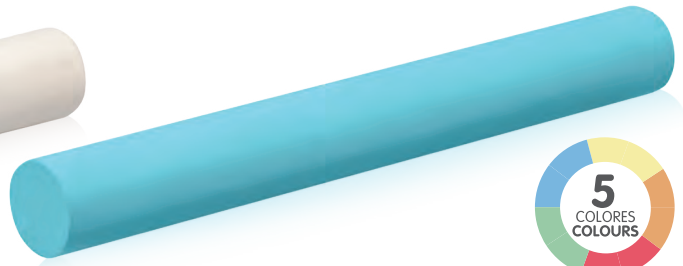

∅ 1 cm

8 cm · 3,8 gr

∅ 1 cm

8 cm · 3,8 gr



rendelési kód: M11171010



**TOP
SELLER**

10 unidades/cajita
units/box
unités/boîte

8,5 x 5 x 2 cm · 46 gr

10 units · 0,57 kg

160 units · 8,70 kg

1037



8411574010371

rendelési kód: M11171100



100 unidades/cajita
units/box
unités/boîte

12 x 8 x 7 cm · 0,92 kg

18 units · 8,10 kg

2404100



8411574037859

rendelési kód: M11172010



**TOP
SELLER**

10 unidades/cajita
units/box
unités/boîte

8,5 x 5 x 2 cm · 46 gr

10 units · 0,52 kg

160 units · 8,70 kg

1047



8411574010470

rendelési kód: M11172100



100 unidades/cajita
units/box
unités/boîte

9,4 x 9,4 x 8,4 cm · 0,42 kg

18 units · 8,10 kg

2414100



8411574037866



21 x 8,2 x 2,5 cm · 110 gr

25 units · 3,10 kg

BWM9165



rendelési kód: MIL000786



24,8 x 10,5 x 2,2 cm · 100 gr

25 units · 2,95 kg

BWM9167



rendelési kód: MIL000788



24,7 x 10,5 x 2,1 cm · 98 gr

25 units · 2,95 kg

BWM9166



rendelési kód: MIL000787

ADAGOLÓS KRÉTAFOGÓ · MECHANICAL CHALK HOLDER · PORTE-CRAIES MÉCANIQUE

rendelési kód: M11175000



14 x 8,2 x 1,7 cm · 58 gr

20 units · 1,02 kg

500 units · 26,10 kg

5342



8411574053422

rendelési kód: MIL000789



14 x 8,2 x 1,7 cm · 58 gr

25 units · 1,65 kg

BWM95342



8411574953425

PORMENTES KRÉTÁK · EASY REMOVE CHALK · CRAIES FACILEMENT EFFAÇABLES

KALCIUM-KARBONÁT
CALCIUM CARBONATE
CARBONATE DE CALCIUM



∅ 1 cm 8 cm · 10,4 gr

POR MENTES

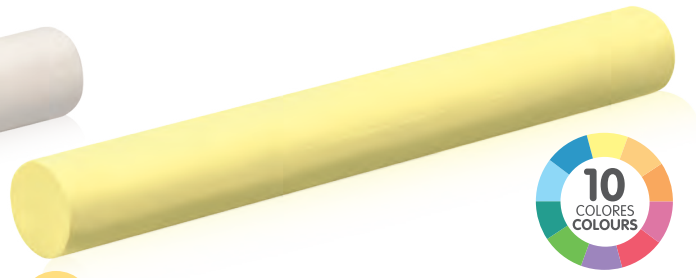

∅ 1 cm 8 cm · 10,4 gr



| | | |
|---|--|--|
| rendelési kód: MIL000739 | rendelési kód: M11176010 | rendelési kód: MIL000036 |
| | | |
| 10 u./cajita u./box u./boîte | 100 u./cajita u./box u./boîte | 100 u./cajita u./box u./boîte |
| 21 x 8,2 x 2,1 cm · 0,22 kg | 8,5 x 5 x 2 cm · 0,10 kg | 10,5 x 8,8 x 9 cm · 1,02 kg |
| 25 units · 5,94 kg | 160 units · 18 kg | 16 units · 17,5 kg |
| BWM10455 | 244210 | 2442100 |
| | | |
| 8411574093121 | 8411574072379 | 8411574072393 |

| | | |
|---|---|--|
| rendelési kód: MIL000741 | rendelési kód: M11177010 | rendelési kód: MIL000037 |
| | | |
| 10 u./cajita u./box u./boîte | 10 u./cajita u./box u./boîte | 100 u./cajita u./box u./boîte |
| 21 x 8,2 x 2,1 cm · 0,22 kg | 8,5 x 5 x 2 cm · 0,10 kg | 10,5 x 8,8 x 9 cm · 1,02 kg |
| 25 units · 5,79 kg | 160 units · 18 kg | 16 units · 17,5 kg |
| BWM10456 | 245210 | 2452100 |
| | | |
| 8411574093138 | 8411574072386 | 8411574072409 |

MINIMALIZÁLJA A HASZNÁLTÓBÓL KELETKEZŐ POR MENNYISÉGÉT · MINIMISE DUST GENERATED WITH USE · MINIMISEZ LA POUSSIERE GÉNÉRÉE PAR L'UTILISATION

KALCIUM-KARBONÁT
CALCIUM CARBONATE
CARBONATE DE CALCIUM



MAXI

∅ 2 cm 10 cm · 55,2 gr

POR MENTES

rendelési kód: M11174M06

rendelési kód: M11174M20

| | |
|---|-----------------------------|
| | |
| 6 unidades/cajita units/box unités/boîte | 6 COLORES COLOURS |
| 14 x 15 x 2,7 cm · 0,26 kg | |
| 24 units · 8,20 kg | |
| 247206 | |
| | |
| 8411574072416 | |

| | |
|--|-----------------------------|
| | |
| 20 unidades/cajita units/box unités/boîte | 7 COLORES COLOURS |
| 12,5 x 11 x 10,8 cm · 1,18 kg | |
| 12 units · 13,6 kg | |
| 247120 | |
| | |
| 8411574072423 | |

Az ecsetek, festékek és egyéb MILAN kiegészítők választékát művészek, hobbi művészek és képzőművészeti hallgatók számára tervezték, amely kiemelkedik minőségével, dizájnjával, valamint széles formátumával és minőségével. A termékválaszték az egyes felhasználók igényeihez és preferenciáihoz lettek tervezve, ezzel segítve a kreativitás szabad kifejezését.

The range of brushes, paints, and other MILAN accessories is designed for artists, enthusiasts, and fine arts students, and stands out for its quality, design, and wide range of formats and qualities. A selection of products to help express creativity, tailored to the needs and preferences of each user.

Les gammes de pinceaux, peintures et autres accessoires MILAN sont conçues pour les artistes, les amateurs et les étudiants en beaux-arts, et se distinguent par la qualité, le design et le large assortiment de formats. Une sélection de produits pour aider à exprimer la créativité, qui s'adapte aux besoins et aux préférences de chaque utilisateur



FESTÉKEK ÉS ECSETEK
PAINT AND BRUSHES
PEINTURE ET
PINCEAUX

UJJFESTÉKEK · FINGER PAINTING PAINT PEINTURE POUR PEINDRE AVEC LES DOIGTS

rendelési kód: MIL000152

6 unidades/cajita
units/box
unités/boîte

25 x 4,5 x 5,5 cm · 0,24 kg

12 units · 3 kg

25 ml

031506



8411574085058



rendelési kód: MIL000193

40 ml

6 unidades/cajita
units/box
unités/boîte

29,8 x 4,9 x 5,1 cm · 0,40 kg

12 units · 5,10 kg

031206



8411574093077



PINTURA PARA DEDOS · FINGER PAINTING

MIXABLE COLOURS
COULEURS MEZCLABLES

Little Ones



031610



rendelési kód: MIL000004

031620



rendelési kód: MIL000006

031652



rendelési kód: MIL000007

031680



rendelési kód: MIL000009

18,5 x Ø 6,8 cm · 0,60 kg

6 units · 3,90 kg

500 ml



100 ml

6 u./cajita
u./box
u./boîte

23,2 x 15 x 5,6 cm · 0,92 kg

6 units · 5,90 kg

5906



rendelési kód: M16171000



100 ml

6 u./cajita
u./box
u./boîte

23,2 x 15 x 5,6 cm · 0,83 kg

6 units · 5,40 kg

0353906



rendelési kód: M16172000

METAL SZÍNEK



TEMPERÁK · POSTER PAINT · GOUACHE

BLISZTERES KIVITEL 14 DARAB 5 ML-ES
TEMPERÁVAL, 12 DARAB KEVERŐ TÉGELYEL
ÉS 1 DARAB ECSETTEL

BLISTER PACK WITH 14 TEMPERA OF 5 ml, 12
MIXING POTS AND BRUSH.

BLISTER AVEC 14 POTS DE GOUACHE DE 5
ml, 12 POTS DE MÉLANGES ET UN PINCEAU.



rendelési kód: M06175K14



5 ml

BRUSH INCLUDED +

2 METAL SZÍN

27,3 x 15 x 2 cm · 0,16 kg

12 units · 2,35 kg

BWM10244

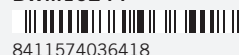

8411574036418



rendelési kód: M06175K06

6 unidades/cajita
units/box
unités/boîte

23,5 x 5,5 x 4 cm · 0,25 kg

15 units · 4 kg

0329906



8411574054917

25 ml

BRUSH INCLUDED +



AJÁNDÉK ECSET · WITH 1 BRUSH · AVEC 1 PINCEAU

rendelési kód: M06174K06



AJÁNDÉK ECSET ÉS PALETTA
WITH 1 BRUSH AND 1 MIXING TRAY
AVEC 1 PINCEAU ET 1 SUPPORT POUR MÉLANGE

6 unidades/cajita
units/box
unités/boîte

25,8 x 14,7 x 5,5 cm · 0,60 kg

8 units · 5,28 kg

03206



8411574011439

40 ml

BRUSH INCLUDED +

TEMPERÁK · POSTER PAINT · GOUACHE

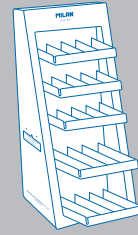

EXPOSITORES
DISPLAYS
PRÉSENTOIRS
PG. 269 >

AJÁNDÉK ECSET ÉS PALETTA
WITH 1 BRUSH AND 1 MIXING TRAY
AVEC 1 PINCEAU ET 1 SUPPORT POUR MÉLANGE

AJÁNDÉK ECSET · WITH 1 BRUSH · AVEC 1 PINCEAU

- 0321006 rendelési kód: M06174500
- 0325206 rendelési kód: M06174101
- 0322006 rendelési kód: M06174550
- 0326006 rendelési kód: M06174301
- 0323306 rendelési kód: M06174670
- 0328006 rendelési kód: M06174200
- 0323006 rendelési kód: M06174403

125 ml **BRUSH INCLUDED**

rendelési kód: M06171K06

6 u./cajita
u./box
u./boîte

18,5 x 12 x 11 cm · 1,02 kg

12 units · 13 kg

03406

8411574013808

40 ml **BRUSH INCLUDED**

rendelési kód: M06174K12

12 u./cajita
u./box
u./boîte

23 x 18 x 5,5 cm · 0,92 kg

6 units · 5,90 kg

03212

8411574011446

40 ml

EGYSZÍNŰ

6 unidades/cajita
units/box
unités/boîte

15 x 10 x 5 cm · 0,42 kg

15 units · 4,10 kg

TEMPERÁK · POSTER PAINT · GOUACHE



125 ml

11,5 x ø 4,5 cm · 0,16 kg

12 units · 2 kg

03410



rendelési kód: M06171500

03419



rendelési kód: M06171550

03420



rendelési kód: M06171562

03432



rendelési kód: M06171600

03422



rendelési kód: M06171650

03433



rendelési kód: M06171670

03430



rendelési kód: M06171403

03452



rendelési kód: M06171101

03450



rendelési kód: M06171100

03440



rendelési kód: M06171700

03460



rendelési kód: M06171301

03461



rendelési kód: M06171300

03470



rendelési kód: M06171800

03480



rendelési kód: M06171200

metal

033493



rendelési kód: M06171930

033410



rendelési kód: M06171524

03491



rendelési kód: M06171910

033440



rendelési kód: M06171707

03492



rendelési kód: M06171900

033461



rendelési kód: M06171307

033480



rendelési kód: M06171857

fluo

034421



rendelési kód: M06171560

034437



rendelési kód: M06171660

034456



rendelési kód: M06171110

034430



rendelési kód: M06171410

500 ml

18,5 x ø 7cm · 0,59 kg

6 units · 3,80 kg

03610



rendelési kód: M06172500

03619



rendelési kód: M06172550

03620



rendelési kód: M06172562

03632



rendelési kód: M06172600

03622



rendelési kód: M06172650

03633



rendelési kód: M06172670

03630



rendelési kód: M06172403

03652



rendelési kód: M06172101

03650



rendelési kód: M06172100

03640



rendelési kód: M06172700

03660



rendelési kód: M06172301

03661



rendelési kód: M06172300

03670



rendelési kód: M06172800

03680



rendelési kód: M06172200

metal

03691



rendelési kód: M06172910

03692



rendelési kód: M06172900

metal

METÁL SZÍNEK

METALLIC COLOURS

COULEURS MÉTALLISÉES

PASTEL

03620P



rendelési kód: M06172558

03622P



rendelési kód: M06172723

03634P



rendelési kód: M06172658

03640P



rendelési kód: M06172708

03652P



rendelési kód: M06172108

03660P



rendelési kód: M06172308

fluo

FLUO SZÍNEK

FLUORESCENT COLOURS

COULEURS FLUORESCENTES

PASTEL

ÚJ PASZTELL SZÍNEK

NEW PASTEL COLOURS

NOUVELLES COULEURS PASTELS

ART

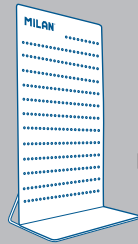

EXPOSITORES
DISPLAYS
PRÉSENTOIRS
PG. 276 >

NEW!



14,4 x 5,4 x 3,3 cm · 117 gr

6 units · 0,73 kg

16
SZÍN
COLOURS
COULEURS

75
ml

ALAP SZÍNEK

METÁL SZÍNEK



ARCTIC WHITE
■ 8

101710



rendelési kód: M19013500



CARIBBEAN BLUE
■ 6-7

101752



rendelési kód: M19013135



TROPICAL YELLOW
■ 7

101720



rendelési kód: M19013550



GRASS GREEN
■ 6-7

101760



rendelési kód: M19013301



BLUSH DALIA
■ 5-6

101722P



rendelési kód: M19013650



TURTLE GREEN
■ 7-8

101761



rendelési kód: M19013334



WATERMELON RED
■ 7-8

101730



rendelési kód: M19013418



EARTH BROWN
■ 8

101770



rendelési kód: M19013832



CORAL RED
■ 6-7

101731



rendelési kód: M19013416



JET BLACK
■ 8

101780



rendelési kód: M19013200



HIBISCUS PINK
■ 7-8

101733



rendelési kód: M19013672



SILVER
■ 5 ☞

101791 **METAL**



rendelési kód: M19013867



QUEEN PURPLE
■ 6-7

101740



rendelési kód: M19013700



GOLD
■ 5 ☞

101792 **METAL**



rendelési kód: M19013578



OCEAN BLUE
■ 6-7

101750



rendelési kód: M19013103



COPPER
■ 5 ☞

101796 **METAL**



rendelési kód: M19013577

| FEDŐKÉPESSÉG RESISTENCIA A LA LUZ LIGHT FASTNESS | min. | max. |
|--|--------------------------|--------------------------|
| <input type="checkbox"/> | <input type="checkbox"/> | <input type="checkbox"/> |
| 1 | 2-3 | 4-5 |
| | 6-7 | 8 |

VÍZFESTÉKEK · WATERCOLOURS · AQUARELLES

NEW DESIGN!



12
Ø 30 mm

BRUSH INCLUDED +

25,5 x 10 x 1,3 cm · 129 gr

15 units · 2,10 kg

80011

8411574800118

rendelési kód: M15171K12

NEW DESIGN!



22
Ø 30 mm

BRUSH INCLUDED +

31 x 13 x 1,5 cm · 0,23 kg

10 units · 2,55 kg

80022

8411574800224

rendelési kód: M15171K22

rendelési kód: M15172K10



10
Ø 45 mm

BRUSH INCLUDED +

31 x 13 x 1,5 cm · 0,25 kg

10 units · 2,75 kg

80009

8411574800095

rendelési kód: M15174K12



12
Ø 25 mm

BRUSH INCLUDED +

18 x 14 x 0,6 cm · 94 gr

14 units · 1,45 kg

053412

8411574027706

rendelési kód: M15173K12

rendelési kód: M15175K12



12
Ø 30 mm

BRUSH INCLUDED +

5 fluo
7 metal
SZÍN

25,5 x 10 x 1,3 cm · 120 gr

15 units · 2 kg

0531512

8411574076599

rendelési kód: M15176K12



12
Ø 30 mm

BRUSH INCLUDED +

22 x 10 x 1,3 cm · 131 gr

12 units · 1,60 kg

72 units · 9,90 kg

053312P

8411574086963

ÚJ FORMULA: RETUSÁLÁS ÉS FEDÉS
 NEW FORMULA: OPAQUE AND COVERING
 NOUVELLE FORMULE: OPAQUE ET COUVRANT



FÉM DOBOZOS VÍZFESTÉK · METAL BOX WITH WATERCOLOURS IN GODET · BOÎTE EN MÉTAL AVEC AQUARELLES EN GODET

rendelési kód: M15177K12



16 x 7,3 x 2,5 cm · 0,17 kg

24 units · 4,10 kg

48 units · 9,00 kg

05B1612



8411574101710



METAL BOX

12 SZÍN COLOURS COULEURS

FESTŐPALETTÁVAL MIXING PALETTE PALETTE DE MÉLANGE



EXPOSITORES DISPLAYS PRÉSENTOIRS PG. 265 >

| | | | | | | | | | | | |
|--------------|-----------------|----------------|---------------|-----------------|--------------|-------------|-----------|-------------|------------|-------------|-----------|
| ARCTIC WHITE | TROPICAL YELLOW | MUSTARD YELLOW | SUNSET ORANGE | WATER-MELON RED | CAMELIA PINK | GRASS GREEN | TURQUOISE | INDIGO BLUE | OCEAN BLUE | MOCCA BROWN | JET BLACK |
| ■ | ■ | □ | □ | □ | □ | □ | □ | □ | □ | □ | □ |
| ** | ** | ** | ** | ** | ** | ** | ** | ** | ** | ** | ** |
| * | * | * | * | * | * | * | * | * | * | * | * |

| | | |
|---|-------|---------|
| FEDŐKÉPESÉG RESISTENCIA A LA LUZ LIGHT FASTNESS | min. | max. |
| | □ | □ |
| | * * * | * * * * |

rendelési kód: M15177K24



26,3 x 7,3 x 2,5 cm · 0,31 kg

12 units · 3,80 kg

24 units · 8,50 kg

05B1624



8411574101727



FÉM DOBOZ

24 SZÍN COLOURS COULEURS



FESTŐPALETTÁVAL MIXING PALETTE PALETTE DE MÉLANGE

| | | |
|---|-------|---------|
| FEDŐKÉPESÉG RESISTENCIA A LA LUZ LIGHT FASTNESS | min. | max. |
| | □ | □ |
| | * * * | * * * * |

| | | | | | | | | | | | |
|--------------|--------------|-----------------|----------------|---------------|------------------|----------|-----------------|--------------|---------------|-------------|-----------|
| ARCTIC WHITE | DAISY YELLOW | TROPICAL YELLOW | MUSTARD YELLOW | SUNSET ORANGE | DANDELION YELLOW | MANDARIN | WATER-MELON RED | CAMELIA PINK | HIBISCUS PINK | GRASS GREEN | TURQUOISE |
| ■ | □ | ■ | □ | □ | ■ | ■ | □ | □ | □ | □ | □ |
| ** | * | ** | ** | ** | * | * | * | * | * | * | * |
| * | * | * | * | * | * | * | * | * | * | * | * |

| | | | | | | | | | | | |
|--------------|--------------|-------------|-----------|--------------------|------------|--------|-----------------|---------------|------------|-------------|-----------|
| TURTLE GREEN | DOLPHIN BLUE | INDIGO BLUE | NAVY BLUE | MEDITERRANEAN BLUE | OCEAN BLUE | VIOLET | LAVENDER PURPLE | ELEPHANT GREY | LAVA BROWN | MOCCA BROWN | JET BLACK |
| □ | □ | □ | □ | ■ | □ | □ | □ | □ | □ | □ | □ |
| ** | ** | ** | ** | ** | ** | ** | ** | ** | ** | ** | ** |
| * | * | * | * | * | * | * | * | * | * | * | * |

EGYSZÍNŰ VÍZFESTÉKEK TÉGELYES KIVITELBEN · INDIVIDUAL COLOR
REPLACEMENTS REMPLAÇABLES INDIVIDUELS DE COULEURS

TÉGELYES VÍZFESTÉK
WATERCOLOR REFILL IN HALF PAN FORMAT
RECHARGE D'AQUARELLE FORMAT DEMI-GODET



24

SZÍN
COULEURS
COULEURS

8 x 5 x 1,5 cm · 5 gr

28 units · 0,28 kg

112 units · 1,40 kg

| | | | | | | | |
|---|---|---|---|---|---|---|---|
| <p>rendelési kód: M15178500</p> <p>05B1110</p> <p>8511574101734</p> | <p>rendelési kód: M15178551</p> <p>05B1115</p> <p>8411574101741</p> | <p>rendelési kód: M15178550</p> <p>05B1120</p> <p>8411574101758</p> | <p>rendelési kód: M15178552</p> <p>05B1119</p> <p>8411574101789</p> | <p>rendelési kód: M15178553</p> <p>05B1118</p> <p>8411574101765</p> | <p>rendelési kód: M15178600</p> <p>05B1125</p> <p>8411574101772</p> | <p>rendelési kód: M15178617</p> <p>05B1132</p> <p>8411574101796</p> | <p>rendelési kód: M15178833</p> <p>05B1128</p> <p>8411574101949</p> |
| <p>rendelési kód: M15178400</p> <p>05B1126</p> <p>8411574101802</p> | <p>rendelési kód: M15178653</p> <p>05B1131</p> <p>8411574101819</p> | <p>rendelési kód: M15178650</p> <p>05B1137</p> <p>8411574101826</p> | <p>rendelési kód: M15178725</p> <p>05B1143</p> <p>8411574101925</p> | <p>rendelési kód: M15178700</p> <p>05B1142</p> <p>8411574101918</p> | <p>rendelési kód: M15178117</p> <p>05B1150</p> <p>8411574101901</p> | <p>rendelési kód: M15178121</p> <p>05B1153</p> <p>8411574101888</p> | <p>rendelési kód: M15178102</p> <p>05B1154</p> <p>8411574101864</p> |
| <p>rendelési kód: M15178104</p> <p>05B1152</p> <p>8411574101895</p> | <p>rendelési kód: M15178100</p> <p>05B1149</p> <p>8411574101871</p> | <p>rendelési kód: M15178316</p> <p>05B1155</p> <p>8411574101840</p> | <p>rendelési kód: M15178303</p> <p>05B1161</p> <p>8411574101857</p> | <p>rendelési kód: M15178300</p> <p>05B1160</p> <p>8411574101833</p> | <p>rendelési kód: M15178800</p> <p>05B1172</p> <p>8411574101956</p> | <p>rendelési kód: M15178850</p> <p>05B1178</p> <p>8411574101932</p> | <p>rendelési kód: M15178200</p> <p>05B1180</p> <p>8411574101963</p> |

ÜRES FÉM DOBOZ · EMPTY METAL BOXES · BOÎTES MÉTALLIQUES VIDES

rendelési kód: MIL000033

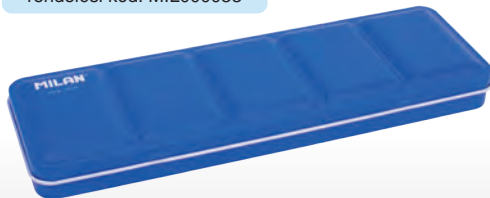

KAPACITÁS
CAPACITY
CAPACITÉ

x24



rendelési kód: MIL000032



KAPACITÁS
CAPACITY
CAPACITÉ

x12



22 x 7 x 2 cm · 0,18 kg

18 units · 3,60 kg

36 units · 7,50 kg

611624



8411574102977

12,5 x 7 x 2 cm · 103 gr

20 units · 2,30 kg

60 units · 7,20 kg

611612



8411574102960

A TÉGELYES ÁTHELVEZHEŐK, ÍGY SAJÁT
SZÍNPALETTA KÉSZÍTHETŐ

GODETS CAN BE COMBINED TO CREATE
YOUR OWN COLOUR PALETTE

LES GODETS PEUVENT ÊTRE COMBINÉS
POUR CRÉER VOTRE PROPRE PALETTE DE
COULEURS

PUHA PASZTELLKRÉTA · SOFT PASTELS · BÂTONS DE PASTEL SOUPLE



rendelési kód: M04206K12

21 x 8,3 x 1,9 cm · 0,17 kg

12 units · 2,40 kg

48 units · 9,00 kg

6110212



8411574102656



12

SZÍN
COULEURS
COULEURS



rendelési kód: M04206K24

21 x 16,2 x 1,9 cm · 0,33 kg

6 units · 2,30 kg

24 units · 9,00 kg

6110224



8411574102663

AJÁNLOTT
RADIR
SUITABLE ERASER
GOMME À EFFACER
ADÉQUATE



Mod. 1220

3,7 x 2,8 x 1 cm



24

SZÍN
COULEURS
COULEURS

FEDŐKÉPESÉG
LIGHT FASTNESS

* ** *** ****
min. max.

MILAN® ART



NÉZ
MEG
A
VIDEÓT!



10
mm

65
mm



EXPOSITORES
DISPLAYS
PRÉSENTOIRS PG. 265 >

PAPÍR VISHEREK · BLENDING STUMPS · ESTOMPES

NEW DESIGN!



MILAN

rendelési kód: F41912BL2

19 x 8,5 x 1,7 cm · 14 gr

10 units · 0,22 kg

200 units · 4,60 kg

BWM94710



8411574947103

6,9 mm

10,5 mm



NÉZD MEG A VIDEÓT!

MILAN® ART



rendelési kód: F41912BL5

24 x 9,75 x 1,7 cm · 48 gr

10 units · 0,52 kg

80 units · 4,63 kg

BWM10495



8411574103318

4,6 mm

6,9 mm

10,5 mm

12,5 mm

18 mm

rendelési kód: F41911046

12 unidades/bolsita
units/pack
unités/sachet

17,5 x 6 x 1 cm · 16 gr

2 units · 46 gr



200 units · 5,2 kg

2800412



8411574037439

Ø 4.6 mm

rendelési kód: F41914125

12 unidades/bolsita
units/pack
unités/sachet

21 x 12 x 2,2 cm · 102 gr

2 units · 0,24 kg



60 units · 8,00 kg

2830412



8411574037460

Ø 12.5 mm

rendelési kód: F41912069

12 unidades/bolsita
units/pack
unités/sachet

17,5 x 8 x 1,3 cm · 31 gr

2 units · 82 gr



200 units · 9 kg

2810412



8411574037446

Ø 6.9 mm

rendelési kód: F41915180

12 unidades/bolsita
units/pack
unités/sachet

20,5 x 14,5 x 3,5 cm · 0,19 kg

2 units · 0,44 kg



32 units · 7,60 kg

2840412



8411574037477

Ø 18 mm

rendelési kód: F41913105

12 unidades/bolsita
units/pack
unités/sachet

20 x 18,5 x 2 cm · 66 gr

2 units · 0,16 kg

80 units · 7,20 kg

2820412



8411574037453

Ø 10.5 mm



rendelési kód: F41915130

3 unidades/bolsita
units/pack
unités/sachet

21,5 x 12 x 3 cm · 98 gr

4 units · 0,46 kg

40 units · 5,10 kg

2850403



8411574049272

Ø 30 mm



RAJZSZENEK · NATURAL CHARCOAL · FUSAINS NATURELS

ART

ÉGERFÁBŐL KÉSZÜLT · MADE OF ALDER WOOD · FABRIQUÉ EN BOIS D'AULNE

| | | | |
|--|---|--|---|
| <p>rendelési kód: M18011004</p>  <p>5 u./cajita u./box u./boîte</p> <p>19,5 x 5 x 1,3 cm · 12 gr</p> <p>650 units · 8,60 kg</p> <p>7800</p>  <p>8411574078005</p> | <p>rendelési kód: M18011008</p>  <p>25 u./cajita u./box u./boîte</p> <p>19,5 x 5 x 3 cm · 28 gr</p> <p>300 units · 10,8 kg</p> <p>7801</p>  <p>8411574078012</p> | <p>rendelési kód: M18013005</p>  <p>5 u./cajita u./box u./boîte</p> <p>19,5 x 5 x 3 cm · 26 gr</p> <p>300 units · 8,90 kg</p> <p>7804</p>  <p>8411574078043</p> | <p>rendelési kód: MIL000224</p>  <p>30 u./cajita u./box u./boîte</p> <p>19,5 x 9 x 4 cm · 98 gr</p> <p>130 units · 14,00 kg</p> <p>7805</p>  <p>8411574078050</p> |
| <p>rendelési kód: M18011003</p>  <p>3 u./cajita u./box u./boîte</p> <p>16 x 3,2 x 1 cm · 10 gr</p> <p>180 units · 2 kg</p> <p>4403</p>  <p>8411574044031</p> | <p>rendelési kód: M18011005</p>  <p>5 u./cajita u./box u./boîte</p> <p>19,5 x 5 x 1 cm · 14 gr</p> <p>650 unit · 9,70 kg</p> <p>7802</p>  <p>8411574078029</p> | <p>rendelési kód: MIL000225</p>  <p>30 u./cajita u./box u./boîte</p> <p>19,5 x 7 x 4 cm · 60 gr</p> <p>170 units · 10,6 kg</p> <p>7803</p>  <p>8411574078036</p> | <p>rendelési kód: M18012005</p>  <p>5 u./cajita u./box u./boîte</p> <p>19 x 5 x 3 cm · 32 gr</p> <p>300 units · 10,40 kg</p> <p>7806</p>  <p>8411574078067</p> |
| <p>rendelési kód: M18011002</p>  <p>6 u./cajita u./box u./boîte</p> <p>16,1 x 4 x 4 cm · 29 gr</p> <p>9 units · 0,40 kg</p> <p>2716106</p>  <p>8411574017783</p> | <p>rendelési kód: MIL000239</p>  <p>4 u./cajita u./box u./boîte</p> <p>16 x 4 x 4 cm · 29 gr</p> <p>440 units · 13,70 kg</p> <p>2716204</p>  <p>8411574017790</p> | <p>rendelési kód: M18011006</p>  <p>5 u./cajita u./box u./boîte</p> <p>19,5 x 5 x 3 cm · 30 gr</p> <p>300 units · 9,70 kg</p> <p>7807</p>  <p>8411574078074</p> | <p>rendelési kód: M18011007</p>  <p>3 u./cajita u./box u./boîte</p> <p>16 x 4 x 4 cm · 36 gr</p> <p>36 units · 1,80 kg</p> <p>2716303</p>  <p>8411574017806</p> |

SZÉNCERUZÁK · CHARCOAL PENCILS · CRAYONS FUSAIN

rendelési kód: M18014K03

MILAN
since 1918

LÁPICES DE CARBÓN
CHARCOAL PENCILS
CRAYONS FUSAIN
KOHLESTIFTE

3 u./cajita
u./box
u./boîte

22,5 x 5,3 x 0,9 cm - 30 gr

12 units - 0,36 kg

144 units - 4,70 kg

07B622203

8411574102687

ART

Ø 4 mm 17,4 x 0,72 cm - 6,6 gr

PUHA · SOFT

MILAN® ART CHARCOAL ○ soft B6222

KÖZEPES · MEDIUM

MILAN® ART CHARCOAL ○ medium B6222

KEMÉNY · HARD

MILAN® ART CHARCOAL ○ hard B6222

FEHÉR MŰVÉSZ CERUZA · WHITE DRAWING PENCILS · CRAYONS À DESSIN BLANCS

rendelési kód: F35172500

MILAN
since 1918

LÁPICES BLANCOS DE DIBUJO
WHITE DRAWING PENCILS
CRAYONS À DESSIN BLANCS
WEISSE ZEICHEN-
Bleistifte

rendelési kód: MIL000828

MILAN
since 1918

LÁPICES BLANCOS DE DIBUJO
WHITE DRAWING PENCILS
CRAYONS À DESSIN BLANCS
WEISSE ZEICHEN-
Bleistifte

goma de miga de pan
synthetic rubber

soft 4824

21 x 8,2 x 1,5 cm - 51 gr

25 units - 1,30 kg

07B222103

8411574100942

BYM10494

8411574103035

ART

MILAN® ART WHITE ○ B221

RAJZOLÁSHOZ, KIEMELÉSHEZ ÉS VÁZLAT KÉSZÍTÉSHEZ FEKETE PAPIRON

TO DRAW, HIGHLIGHT OR SKETCH ON DARK PAPER

POUR DESSINER, SURLIG-NER OU FAIRE DES ESQUIS-SES SUR DU PAPIER FONCÉ

MAGAS FÉNYELLENÁLLÁS
HIGHLY RESISTANT TO LIGHT
TRÈS RÉSISTANTS À LA LUMIÈRE

A kézműves Milan ecsetek kitűnnek az ecsetsörték minőségével. Ecsetek széles választékát kínáljuk a legkülönfélébb alkalmazásokhoz.

MILAN brushes are handcrafted and stand out due to the different qualities of their hair. Wide range of brushes for a wide variety of applications.

Les pinceaux MILAN de fabrication artisanale se distinguent par leur variété de qualité de poils. Large gamme de pinceaux pour une grande variété d'applications.

FOGLALAT · FERRULE · VIROLE

Fémből készült foglalat, amely a sörtéket csatolja az ecset fogórészéhez. Minden Milan foglalat stabil és alumíniumból készül, nikkelt, króm vagy nikkelt ónnal bevonva (ellenáll a rozsdásodásnak).

It is the metal part that connects the bristles with the handle of the brush. All ferrules of MILAN brushes are seamless and made of aluminium, nickel or chrome plated (resistant to rust), or nickel plated tin.

C'est la partie métallique qui unit les poils au manche du pinceau. Toutes les viroles des pinceaux MILAN sont sans soudure et sont fabriquées en aluminium, en laiton nikkélé ou chromé (résistant à l'oxydation), ou en étain nikkélé.

MÉRET · SIZE · TAILLE

Minden ecset elérhető különböző méretekben, követte a sztenderd számozást.

Each model is available in different sizes, following standardised numbering.

Chaque modèle est disponible en différentes tailles selon la numérotation standard.

SZÉRIASZÁM · SERIES NUMBER · NUMÉRO DE SÉRIE

Jelzi az adott Milan ecset szériáját.

Indicates the series of the MILAN brush model. II

indique la série du modèle de pinceau MILAN.

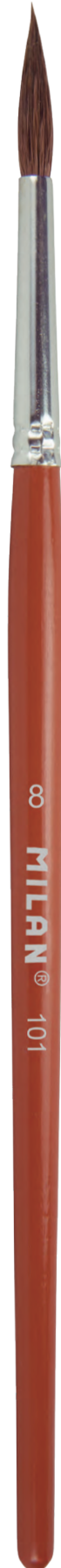

SÖRTÉK ÖSSZETÉTELE · COMPOSITION OF THE BRISTLES · COMPOSITION DES POILS

Természetes póniszőr, sertéssőr vagy szintetikus.

With natural pony hair, chungking bristle hair and synthetic or sponge hair.

Avec poils de chèvre naturels, poils chungking et poils synthétiques ou éponge.

HEGY FORMÁK · FORM OF THE TIP · FORME DE LA POINTE

Kerek, lapos, hengeres vagy macskanyelv.

Rounded, flat, spalter, or cat tongue brush. Ronde, plate, spalter ou langue de chat.

FOGÓRÉS · HANDLE · MANCHE

Lakkozott fa vagy műanyag. A rövidebb fogórész ideális vízfestékes használathoz, amíg a hosszabb fogórész jobb olaj- és akril festményekhez.

Varnished wood or plastic. The short handle is suitable for watercolour and the long handle is better suited to oil and acrylic.

En bois verni ou en plastique. Le manche court est idéal pour l'aquarelle alors que le manche long est plus conseillé pour la peinture à l'huile ou acrylique.



SÖRTE ÁTMÉRŐJE · Diameter of the hair · Diamètre du poil



SÖRTE SZÉLESSÉGE · Width of the hair · Largeur du poil



SÖRTE VASTAGSÁGA · Thickness of the hair · Epaisseur du poil



SÖRTE HOSSZA · Length of the hair · Longueur du poil



ECSET HOSSZA · Length of the brush · Longueur du pinceau



CSOMAGOLÁS MÉRETE · Pack size. Nombre de pinceaux par sachet ou boîte.

101w

101

116

121

131

212

213

221

511

514

524

526

512

531

513

522

501

20

21

22

301

311

321

611

621

641

631

612

642

622

822

842

711

WATER BRUSH

1321

1311

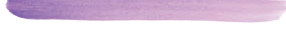

70% PÓNISZŐR + 30% SZINTETIKUS
70% PONY HAIR + 30% SYNTHETIC BRUSHES
PINCEAUX 70% PONEY DE CHÈVRE + 30% SYNTHÉTIQUES

SERTÉSSŐRTE
CHUNGKING PIG
HAIR BRUSHES
PINCEAUX EN SOIE DE CHUNGKING

SZINTETIKUS SŐRTE
SYNTHETIC HAIR BRUSHES
PINCEAUX EN POILS SYNTHÉTIQUES

ÚJRATÖLTHETŐ ECSETTOLL
REFILLABLE WATER BRUSH
PINCEAU RECHARGEABLE AVEC RÉSERVOIR D'EAU

SZIVACCS "ECSET"
SPONGE "BRUSH"
PINCEAU "ÉPONGE"

**70% PÓNISZŐR + 30% SZINTETIKUS ECSETEK · 70% PONY HAIR + 30%
SYNTHETIC BRUSHES · PINCEAUX 70% PONEY DE CHÈVRE + 30%
SYNTHÉTIQUES**

A víz és a festék jobb megtartása. Sima vonalak. Jobb ellenállás és rugalmasság, amely lehetővé teszi alakjának helyreállítását használat után. Ellenálló, zökkenőmentes alumínium foglalat. Nagyon sima, akvarell és temperás technikákhoz ajánlott.

Better retention of water and paint. Smoother lines. Better resistance and elasticity, which facilitates the recovery of its shape after use. Resistant, seamless aluminium ferrule. Very smooth, intended for watercolour and poster paint techniques.

Une plus grande rétention d'eau et de peinture. Une plus grande souplesse du trait. Une plus grande résistance et élasticité, qui permettent au pinceau de récupérer sa forme d'origine après son utilisation. Virole en aluminium résistante et sans soudure. Pinceaux plus souples, conseillés pour les techniques d'aquarelle et de gouache.

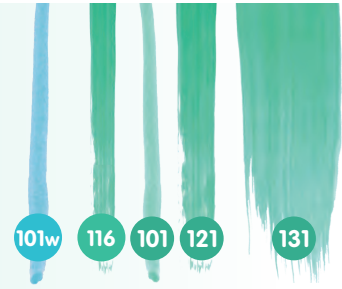

serie
101w
series

Fa fogórész, kerekített póniszőr- és szintetikus szálakkal.
Round tip, pony and synthetic hair, with a wooden handle.
Pointe ronde en poils de chèvre et synthétiques avec manche en bois.

rendelési kód:
M12174K04



27 x 9 x 1 cm · 21 gr
10 units · 0,27 kg
200 units · 6 kg

101w
Serie · Serie · Série
n. 2, 4, 6, 8,



| Serie 101w | 101w/2 | 101w/4 | 101w/6 | 101w/8 |
|------------|--------|---------|---------|---------|
| | 2mm | 2,6mm | 3,3mm | 4,3mm |
| | 8mm | 11,5mm | 17mm | 19mm |
| | 166mm | 166,5mm | 169,8mm | 183,2mm |



BWM10468



8411574095460

serie
116
series

Műanyag, gumírozott fogórész, kerekített póniszőr- és szintetikus szálak.
Round tip, pony and synthetic hair, with plastic handle and non-slip grip.
Pointe ronde en poils de chèvre et synthétiques avec manche en plastique antidérapant.

rendelési kód:
M12176K03



26,4 x 8,4 x 1 cm · 29 gr
10 units · 0,34 kg
200 units · 7,5 kg

116
Serie · Serie · Série
n. 2, 8, 12



| Serie 116 | 116/2 | 116/8 | 116/12 |
|-----------|---------|---------|---------|
| | 3,1mm | 5,1mm | 6,1mm |
| | 16mm | 22mm | 26mm |
| | 177,6mm | 189,6mm | 196,3mm |



BWM10463



8411574093725

serie
101
series

101
Serie · Serie · Série
n. 00, 0,
1, 2, 3,
4, 5, 6,
7, 8, 9,
10, 11, 12

144

u./cajita
u./box
u./boîte



rendelési kód:
M12171144

144 db-os kiszervezés. Tartalmaz: 12 db ecsetet 00-tól 8-as méretig, és 6 db ecsetet 9-től 12-es méretig.

Tray of 144 round brushes. Contains: 12 brushes number 00 to 8 and 6 of the 9 to 12.

Set 144 pinceaux, ronds. Contenu: 12 pinceaux des n° 00 à 8 et 6 des n° 9, n° 10, n° 11 et n° 12.

47 x 24,5 x 2,5 cm · 0,55 kg

1 unit · 0,69 kg

10 units · 7,40 kg

80318



8411574803188

70% PÓNISZŐR + 30% SZINTETIKUS ECSETEK · 70% PONY HAIR + 30%
SYNTHETIC BRUSHES · PINCEAUX 70% POILS DE CHÈVRE + 30% SYNTHÉTIQUES

serie
101
séries

Rövid fogórész, kerekített ecset. Short handle rounded brush. Pinceau rond avec manche court.



**TOP
SELLER**

ÚJ CIKKSZÁM A CSOMAGOLÁSON · NEW CODING PER BAG · NOUVEAU CODAGE POUR POCLETTE

Serie
101



| | | | | | | | |
|--------------------------|--------------------------|--------------------------|--------------------------|--------------------------|--------------------------|--------------------------|--------------------------|
| 80298B 101/000 | 80299B 101/00 | 80300B 101/0 | 80301B 101/1 | 80302B 101/2 | 80303B 101/3 | 80304B 101/4 | 80305B 101/5 |
| 2mm | 2mm | 2mm | 2,2mm | 2,3mm | 2,7mm | 2,9mm | 3,4mm |
| 7,5mm | 7,5mm | 7,5mm | 9,9mm | 10mm | 11,6mm | 12,2mm | 15,7mm |
| 160mm | 163mm | 164mm | 165mm | 166mm | 169mm | 170mm | 176mm |
| 12 units / bag | 12 units | 12 units | 12 units | 12 units | 12 units | 12 units | 12 units |
| | | | | | | | |
| rendelési kód: M12171000 | rendelési kód: M12171P00 | rendelési kód: M12171PP0 | rendelési kód: M12171001 | rendelési kód: M12171002 | rendelési kód: M12171003 | rendelési kód: M12171004 | rendelési kód: M12171005 |

Serie
101



| | | | | | | | |
|--------------------------|--------------------------|--------------------------|--------------------------|--------------------------|--------------------------|--------------------------|---------------------------|
| 80306B 101/6 | 80307B 101/7 | 80308B 101/8 | 80309B 101/9 | 80310B 101/10 | 80311B 101/11 | 80312B 101/12 | 0410114B 101/14 |
| 3,7mm | 4,2mm | 4,5mm | 5mm | 5,2mm | 6mm | 6mm | 6,6mm |
| 17mm | 20mm | 20,6mm | 21,2mm | 23,6mm | 25,6mm | 16,2mm | 27,1mm |
| 180mm | 185mm | 182mm | 191mm | 195mm | 198mm | 200mm | 200mm |
| 12 units / bag | 12 units | 6 units | 6 units | 6 units | 6 units | 6 units | 6 units |
| | | | | | | | |
| rendelési kód: M12171006 | rendelési kód: M12171007 | rendelési kód: M12171008 | rendelési kód: M12171009 | rendelési kód: M12171010 | rendelési kód: M12171011 | rendelési kód: M12171012 | rendelési kód: M12171014 |

Serie
101



| | | | | |
|---------------------------|---------------------------|---------------------------|---------------------------|---------------------------|
| 0410116B 101/16 | 0410118B 101/18 | 0410120B 101/20 | 0410122B 101/22 | 0410124B 101/24 |
| 3,7mm | 4,2mm | 4,5mm | 5mm | 5,2mm |
| 17mm | 20mm | 20,6mm | 21,2mm | 23,6mm |
| 180mm | 185mm | 182mm | 191mm | 195mm |
| 6 units / bag | 6 units | 3 units | 3 units | 3 units |
| | | | | |
| rendelési kód: M12171016 | rendelési kód: M12171018 | rendelési kód: M12171020 | rendelési kód: M12171022 | rendelési kód: M12171024 |



80306B
101/6



EXPOSITORES
DISPLAYS
PRÉSENTOIRS
PG. 270 >

Serie
101



| | | | | | | |
|--------------------------|--------------------------|--------------------------|--------------------------|--------------------------|--------------------------|--------------------------|
| 80298P 101/000 | 80300P 101/0 | 80302P 101/2 | 80304P 101/4 | 80306P 101/6 | 80308P 101/8 | 80310P 101/10 |
| 2mm | 2mm | 2,3mm | 2,9mm | 3,7mm | 4,5mm | 5,2mm |
| 7,5mm | 7,5mm | 10mm | 12,2mm | 17mm | 20,6mm | 23,6mm |
| 160mm | 164mm | 166mm | 170mm | 180mm | 182mm | 195mm |
| | | | | | | |
| rendelési kód: MIL000419 | rendelési kód: MIL000420 | rendelési kód: MIL000423 | rendelési kód: MIL000425 | rendelési kód: MIL000432 | rendelési kód: MIL000468 | rendelési kód: MIL000471 |

Serie
101



| | | | | | | |
|--------------------------|---------------------------|---------------------------|---------------------------|---------------------------|---------------------------|---------------------------|
| 80312P 101/12 | 0410114P 101/14 | 0410116P 101/16 | 0410118P 101/18 | 0410120P 101/20 | 0410122P 101/22 | 0410124P 101/24 |
| 6mm | 2,3mm | 2,9mm | 3,7mm | 4,5mm | 5mm | 5,2mm |
| 16,2mm | 10mm | 12,2mm | 17mm | 20,6mm | 21,2mm | 23,6mm |
| 200mm | 166mm | 170mm | 180mm | 182mm | 191mm | 195mm |
| | | | | | | |
| rendelési kód: MIL000475 | rendelési kód: MIL000072 | rendelési kód: MIL000073 | rendelési kód: MIL000074 | rendelési kód: MIL000075 | rendelési kód: MIL000076 | rendelési kód: MIL000079 |



ÚJ
SZÓLÓ
KISZERELÉS

NEW
DESIGN!

rendelési kód: M12171120

101

Serie · Serie · Série
n. 1, 2, 4,
6, 8, 10



120 db-os kiszerelés. Tartalmaz: 24 db ecsetet 1-es, 2-es, 4-es és 6-os méretekből, illetve 12 db ecsetet 8-as és 10-es méretekből.

Tray of 120 round brushes (series 101). Contains: 24 brushes n° 1, 2, 4 and 6. 12 brushes n° 8 and 10.

Set 120 pinceaux, ronds (série 101). Contenu: 24 pinceaux des n° 1, 2, 4 et 6. 12 pinceaux des n° 8 et 10.

04000101120



8411574022053

28 x 26 x 2,5 cm · 0,35 kg

1 unit · 0,69 kg

10 units · 7,40 kg

BRUSHES
SET



PG. 134

120

u./cajita
u./box
u./boîte

70% PÓNISZŐR + 30% SZINTETIKUS ECSETEK · 70% PONY HAIR + 30%
SYNTHETIC BRUSHES · PINCEAUX 70% POILS DE CHÈVRE + 30% SYNTHÉTIQUES

serie
121
series

Rövid fogórész, lapos ecset. Short handle flat brush. Pinceau plat avec manche court.



ÚJ CIKKSZÁM A CSOMAGOLÁSON · NEW CODING PER BAG · NOUVEAU CODAGE POUR POCLETTE

| Serie 121 | 0412100B 121/0 | 0412102B 121/2 | 0412104B 121/4 | 0412106B 121/6 | 0412108B 121/8 | 0412110B 121/10 | 0412112B 121/12 | 0412114B 121/14 |
|-----------|--------------------------|--------------------------|--------------------------|--------------------------|--------------------------|--------------------------|--------------------------|--------------------------|
| | 3,1mm | 3,5mm | 5,2mm | 6,8mm | 8,1mm | 9,2mm | 11mm | 11,5mm |
| | 1,1mm | 1,5mm | 2,4mm | 2,4mm | 3,1mm | 3,9mm | 3,9mm | 4mm |
| | 6mm | 6,1mm | 7,8mm | 8,7mm | 11,1mm | 12,4mm | 13,9mm | 14mm |
| | 160mm | 174mm | 181mm | 182mm | 182mm | 189mm | 194mm | 195mm |
| | 12 units / bag | 12 units | 12 units | 12 units | 6 units | 6 units | 6 units | 6 units |
| | | | | | | | | |
| | rendelési kód: M12170000 | rendelési kód: M12170002 | rendelési kód: M12170004 | rendelési kód: M12170006 | rendelési kód: M12170008 | rendelési kód: M12170010 | rendelési kód: M12170012 | rendelési kód: M12170014 |

| Serie 121 | 0412116B 121/16 | 0412118B 121/18 | 0412120B 121/20 | 0412122B 121/22 | 0412124B 121/24 |
|-----------|--------------------------|--------------------------|--------------------------|--------------------------|--------------------------|
| | 13mm | 13,2mm | 14,8mm | 16,1mm | 18mm |
| | 4mm | 4,1mm | 4,1mm | 4,2mm | 4,8mm |
| | 16mm | 17,1mm | 18,2mm | 19,4mm | 22,8mm |
| | 195mm | 199mm | 201mm | 202mm | 209mm |
| | 6 units / bag | 6 units | 3 units | 3 units | 3 units |
| | | | | | |
| | rendelési kód: M12170016 | rendelési kód: M12170018 | rendelési kód: M12170020 | rendelési kód: M12170022 | rendelési kód: M12170024 |



| Serie 121 | 0412100P 121/0 | 0412102P 121/2 | 0412104P 121/4 | 0412106P 121/6 | 0412108P 121/8 | 0412110P 121/10 | 0412112P 121/12 |
|-----------|--------------------------|--------------------------|--------------------------|--------------------------|--------------------------|--------------------------|--------------------------|
| | 3,1mm | 3,5mm | 5,2mm | 6,8mm | 8,1mm | 9,2mm | 11mm |
| | 1,1mm | 1,5mm | 2,4mm | 2,4mm | 3,1mm | 3,9mm | 3,9mm |
| | 6mm | 6,1mm | 7,8mm | 8,7mm | 11,1mm | 12,4mm | 13,9mm |
| | 160mm | 174mm | 181mm | 182mm | 182mm | 189mm | 194mm |
| | | | | | | | |
| | | | | | | | |
| | rendelési kód: MIL000080 | rendelési kód: MIL000081 | rendelési kód: MIL000082 | rendelési kód: MIL000083 | rendelési kód: MIL000084 | rendelési kód: MIL000085 | rendelési kód: MIL000086 |

| Serie 121 | 0412114P 121/14 | 0412116P 121/16 | 0412118P 121/18 | 0412120P 121/20 | 0412122P 121/22 | 0412124P 121/24 |
|-----------|--------------------------|--------------------------|--------------------------|--------------------------|--------------------------|--------------------------|
| | 11,5mm | 13mm | 13,2mm | 14,8mm | 16,1mm | 18mm |
| | 4mm | 4mm | 4,1mm | 4,1mm | 4,2mm | 4,8mm |
| | 14mm | 16mm | 17,1mm | 18,2mm | 19,4mm | 22,8mm |
| | 195mm | 195mm | 199mm | 201mm | 202mm | 209mm |
| | | | | | | |
| | | | | | | |
| | rendelési kód: MIL000087 | rendelési kód: MIL000088 | rendelési kód: MIL000089 | rendelési kód: MIL000090 | rendelési kód: MIL000091 | rendelési kód: MIL000092 |



serie
131
series

Rövid fogórész, széles lapos ecset falfestmények készítésére.
Short handle spalter brush for creating murals.
Pinceau spalter avec manche court, idéal pour la réalisation de peintures murales.



| Serie 131 | 0413125 131/25 | 0413135 131/35 |
|-----------|--------------------------|--------------------------|
| | 25mm | 35mm |
| | 5,5mm | 5,8mm |
| | 25,2mm | 30,1mm |
| | 192mm | 208mm |
| | 1 unit / bag | 1 unit |
| | | |
| | rendelési kód: M12168025 | rendelési kód: MIL000195 |



SERTÉSSÖRTE ECSET · CHUNGKING PIG HAIR BRUSHES PINCEAUX EN SOIE DE CHUNGKING

Nagy ellenálló képesség és tartósság. Ragasztókhöz, lakkokhoz, vízfestékekhez és vastag festményekhez ajánlott.

High resistance and durability. Intended for glue, varnishes, poster paint and thick paint.

Grande résistance et durabilité. Pinceaux conseillés pour l'application de colle, vernis, gouache et de couches épaisses de peinture.



serie
212
series

Kerekített ecset. Műanyag fogórész és foglalat, ragasztókhöz tervezve. A foglalat védő részes, amely megakadályozza a ragasztó csöpögését függőleges tartásban.

Rounded brush. Plastic handle and ferrule, designed for applying glue. Ferrule nut with a protective support preventing it from fully entering the can and preventing dripping of glue when put in a vertical position.

Pinceau rond avec manche et virole en plastique, conçu pour l'application de colle. Virole avec support protecteur qui empêche le pinceau d'être entièrement introduit dans le pot de colle et évite que celle-ci ne coule lorsqu'il est placé en position verticale.

Serie 212



| 0421201 212/1 | 0421202 212/2 | 0421203 212/3 |
|------------------|------------------|------------------|
| 6,3mm | 9,5mm | 12,7mm |
| 18,6mm | 29,9mm | 37mm |
| 173mm | 178mm | 186mm |
| 12 units / box | 12 units | 12 units |



VÉDŐGYŰRŰ · Protective band · Support protecteur

0421202
212/2



serie
213
series

Kerekített ecset műanyag foglalattal és ergonomikus fogórészsel, amely könnyebb használatot tesz lehetővé a gyermekek számára. A lapos aljával megakadályozza, hogy lecsússzon a munkafelületről.

Rounded brush with plastic ferrule and ergonomic plastic handle. Easy to hold for children, with a flat base that prevents it from rolling over the work surface.

Pinceau rond avec virole en plastique, et manche ergonomique en plastique. Facile à prendre en main pour les enfants, il bénéficie d'une base plate qui l'empêche de rouler sur la surface de travail.



8411574012214

Könnyű fogás gyermekeknek · Easy to hold for children
Facile à prendre en main pour les enfants

NEW
DESIGN!

Serie 213



| 0421300 213 |
|----------------|
| 13,4mm |
| 37,5mm |
| 155mm |
| 12 units / box |

rendelési kód: M12198000



serie
221
series

Lapos ecset alumínium foglalattal és rövid fa fogórészsel.
Flat brush with an aluminium ferrule and short wooden handle.
Pinceau plat avec virole en aluminium et manche court en bois.



8411574106951

NEW
DESIGN!

ÚJ
CIKKSZÁM A
CSOMAGOLÁSON!
NEW CODING
PER BAG
NOUVEAU
CODAGE POUR
POCHETTE

Serie 221



| 0422100B 221/0 |
|-------------------|
| 10,1mm |
| 4,1mm |
| 20,7mm |
| 133mm |
| 10 units / bag |

rendelési kód: M12194000



serie
511
series

Kerekített ecset ergonomikus fa fogórészsel és nikkelezett foglalattal.
Rounded brush with an ergonomic wooden handle and a nickel plated ferrule.
Pinceau rond avec manche en bois ergonomique et virole en laiton nickelé.



BRUSHES
SET



0451106B
511/6

| Serie 511 | 0451102B 511/2 | 0451104B 511/4 | 0451106B 511/6 | 0451108B 511/8 | 0451110B 511/10 | 0451112B 511/12 | 0451114B 511/14 | 0451116B 511/16 |
|-----------|-------------------|-------------------|-------------------|-------------------|--------------------|--------------------|--------------------|--------------------|
| | 2,2mm | 2,9mm | 3,7mm | 4,4mm | 5,2mm | 5,6mm | 6,8mm | 7,5mm |
| | 9,8mm | 10,4mm | 18,2mm | 19,9mm | 21,6mm | 26mm | 29,1mm | 30,1mm |
| | 175mm | 180mm | 187mm | 192mm | 196mm | 203mm | 205mm | 210mm |
| | 10 units / bag | 8 units | 8 units | 8 units | 6 units | 6 units | 6 units | 4 units |



ÚJ CIKKSZÁM A CSOMAGOLÁSON · NEW CODING PER BAG · NOUVEAU CODAGE POUR Pochette

SERTÉSSÖRTE ECSETEK · CHUNGKING PIG HAIR BRUSHES PINCEAUX EN SOIE DE CHUNGKING

serie
514
series

Kerekített ecset természetes lakkozott fenyő színű, rövid fogórésszel, alumínium foglalattal.
Rounded brush with a natural pine colour varnished ergonomic short handle, and a seamless aluminium ferrule.
Pinceau à poils courts avec virole en aluminium sans soudure et manche court, vernis de couleur pin naturel.



0451406B
514/6

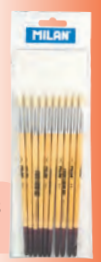

ÚJ CIKKSZÁM A CSOMAGOLÁSON · NEW CODING PER BAG · NOUVEAU CODAGE POUR POCLETTE

Serie
514

| | 0451402B 514/2 | 0451404B 514/4 | 0451406B 514/6 | 0451408B 514/8 | 0451410B 514/10 | 0451412B 514/12 | 0451414B 514/14 | 0451416B 514/16 | 0451418B 514/18 |
|--|--------------------------|--------------------------|--------------------------|--------------------------|---------------------------|---------------------------|---------------------------|---------------------------|---------------------------|
| | 3,5mm | 4,1mm | 4,6mm | 5mm | 5,3mm | 5,9mm | 6,4mm | 6,9mm | 7,7mm |
| | 11mm | 12,4mm | 14,3mm | 15,6mm | 17,4mm | 19,8mm | 21,2mm | 23,6mm | 26mm |
| | 180mm | 181mm | 185mm | 188mm | 201mm | 205mm | 207mm | 223mm | 232mm |
| | 12 units / bag | 12 units | 10 units | 10 units | 6 units | 6 units | 6 units | 6 units | 4 units |
| | | | | | | | | | |
| | rendelési kód: M12187002 | rendelési kód: M12187004 | rendelési kód: M12187006 | rendelési kód: M12187008 | rendelési kód: M12187010 | rendelési kód: M12187012 | rendelési kód: M12187014 | rendelési kód: M12187016 | rendelési kód: M12187018 |

serie
524
series

Lapos ecset természetes lakkozott fenyő színű, rövid fogórésszel, alumínium foglalattal.
Flat brush with a natural pine colour varnished ergonomic short handle, and a seamless aluminium ferrule.
Pinceau plat avec manche court et ergonomique, avec virole en aluminium sans soudure, vernis de couleur pin naturel.



BRUSHES
SET

PG.135

0452406B
524/6

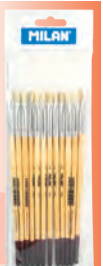

ÚJ CIKKSZÁM A CSOMAGOLÁSON · NEW CODING PER BAG · NOUVEAU CODAGE POUR POCLETTE

Serie
524

| | 0452402B 524/2 | 0452404B 524/4 | 0452406B 524/6 | 0452408B 524/8 | 0452410B 524/10 | 0452412B 524/12 | 0452414B 524/14 | 0452416B 524/16 | 0452418B 524/18 |
|--|--------------------------|--------------------------|--------------------------|--------------------------|---------------------------|---------------------------|---------------------------|---------------------------|---------------------------|
| | 3,7mm | 4,9mm | 6mm | 7,7mm | 8,5mm | 9mm | 9,2mm | 10mm | 11,2mm |
| | 1,5mm | 1,8mm | 2,3mm | 3mm | 3,6mm | 5mm | 4mm | 4,2mm | 4,2mm |
| | 9,3mm | 11,6mm | 11,3mm | 11,4mm | 12,6mm | 13,6mm | 16,6mm | 17mm | 19,2mm |
| | 174mm | 183mm | 193mm | 198mm | 199mm | 205mm | 208mm | 223mm | 225mm |
| | 12 units / bag | 12 units | 12 units | 10 units | 6 units | 6 units | 6 units | 6 units | 4 units |
| | | | | | | | | | |
| | rendelési kód: M12167002 | rendelési kód: M12167004 | rendelési kód: M12167006 | rendelési kód: M12167008 | rendelési kód: M12167010 | rendelési kód: M12167012 | rendelési kód: M12167014 | rendelési kód: M12167016 | rendelési kód: M12167018 |

serie
526
series

Műanyag, gumírozott fogórésszel, lapos sertéssörte ecset.
Flat tip, Chungking pig hair, with plastic handle and non-slip grip
Pointe plate en soie de Chungking, avec manche en plastique antidérapant.



rendelési kód: M12177K03

26,4 x 8,4 x 1 cm · 28 gr
10 units · 0,33 kg
200 units · 7,3 kg

526
Serie · Serie · Série
n. 8, 10, 12

Serie
526

| | BWM10464 526/8 | BWM10464 526/10 | BWM10464 526/12 |
|--|--------------------------|---------------------------|---------------------------|
| | 6mm | 7,9mm | 10,1mm |
| | 2,7mm | 3,4mm | 4,2mm |
| | 12mm | 14mm | 18,5mm |
| | 174mm | 183,2mm | 189,8mm |

BWM10464

8411574093732



SERTÉSSÖRTE ECSETEK · CHUNGKING PIG HAIR BRUSHES PINCEAUX EN SOIE DE CHUNGKING

Olajfestményekhez használatos a tartósságának és sűrűségének köszönhetően. Az ecset megtartja a festéket, ezáltal ideális textúrák és vastagságok kidolgozásához.

Used for oil painting, due to its firmness and solidity. The brush holds the paint between the bristles, and is ideal for work with textures and thicknesses.

Grande résistance et durabilité. Utilisé pour la peinture à l'huile du fait de sa fermeté et de sa solidité. Le pinceau retient la peinture entre les poils, ce qui en fait un outil très adapté pour les travaux épais et texturés.

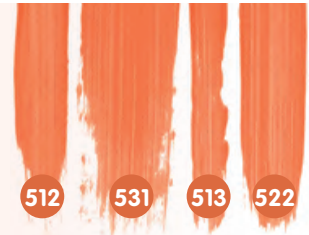

serie
512
series

Kerekített ecset természetes, lakkozott, fenyő színű, hosszú fogórészsel és alumínium foglalattal.
Round brush with a natural pine colour varnished long handle, and a seamless aluminium ferrule.
Pinceau rond avec manche long en bois vernis de couleur pin naturel et virole en aluminium sans soudure.



ÚJ CIKKSZÁM A CSOMAGOLÁSON · NEW CODING PER BAG · NOUVEAU CODAGE POUR POCLETTE

| Serie 512 | 80341B 512/1 | 80342B 512/2 | 80343B 512/3 | 80344B 512/4 | 80345B 512/5 | 80346B 512/6 | 80347B 512/7 | 80348B 512/8 |
|-----------|--------------------------|--------------------------|--------------------------|--------------------------|--------------------------|--------------------------|--------------------------|--------------------------|
| | 3,7mm | 4,4mm | 5,1mm | 6,1mm | 7mm | 7,9mm | 8,8mm | 9,9mm |
| | 13,6mm | 13,7mm | 15,1mm | 19,1mm | 19,7mm | 22,5mm | 25,5mm | 27,7mm |
| | 285mm | 290mm | 295mm | 300mm | 305mm | 310mm | 315mm | 320mm |
| | 6 units / bag | 6 units | 6 units | 6 units | 6 units | 6 units | 6 units | 6 units |
| | | | | | | | | |
| | rendelési kód: M12173001 | rendelési kód: M12173002 | rendelési kód: M12173003 | rendelési kód: M12173004 | rendelési kód: M12173005 | rendelési kód: M12173006 | rendelési kód: M12173007 | rendelési kód: M12173008 |

| Serie 512 | 80349B 512/9 | 80350B 512/10 | 80351B 512/11 | 80352B 512/12 |
|-----------|--------------------------|--------------------------|--------------------------|--------------------------|
| | 10,5mm | 12,2mm | 14mm | 15,5mm |
| | 32,4mm | 35mm | 38,1mm | 42,2mm |
| | 325mm | 330mm | 335mm | 340mm |
| | 6 units / bag | 6 units | 4 units | 4 units |
| | | | | |
| | rendelési kód: M12173009 | rendelési kód: M12173010 | rendelési kód: M12173011 | rendelési kód: M12173012 |



80346B
512/6

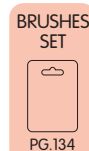

BRUSHES SET
PG.134

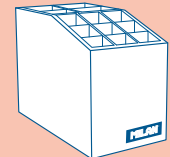

EXPOSITORES
DISPLAYS
PRÉSENTOIRS
PG. 271 >

serie
531
series

Széles ecset természetes, lakkozott, fenyő színű, rövid fogórészsel és nikkelezett foglalattal. Lakkozáshoz, illetve akril- és olajfestmények háttéréhez használatos.

Spalter with a natural pine colour varnished short handle, and a nickel plated tin ferrule. Intended for creating backgrounds in acrylic and oil and the application of varnishes.

Pinceau spalter avec manche court en bois vernis de couleur pin naturel et virole en étain nickelé. Il est conseillé pour la réalisation de fonds à la peinture à l'huile et acrylique et l'application de vernis.

NEW
DESIGN!



0453135
531/35

NEW
DESIGN!



| Serie 531 | 0453120 531/20 | 0453125 531/25 | 0453130 531/30 | 0453135 531/35 | 0453140 531/40 | 0453145 531/45 | 0453160 531/60 | 0453170 531/70 |
|-----------|--------------------------|--------------------------|--------------------------|--------------------------|--------------------------|--------------------------|--------------------------|--------------------------|
| | 20mm | 25mm | 30mm | 35mm | 40mm | 45mm | 60mm | 70mm |
| | 5,2mm | 5,2mm | 5,2mm | 5,8mm | 6mm | 6,9mm | 7,4mm | 7,4mm |
| | 25,6mm | 25,9mm | 28mm | 30mm | 31,6mm | 33,4mm | 35,9mm | 40mm |
| | 1 unit / bag | 1 unit | 1 unit | 1 unit | 1 unit | 1 unit | 1 unit | 1 unit |
| | | | | | | | | |
| | rendelési kód: M12196020 | rendelési kód: M12196025 | rendelési kód: M12196030 | rendelési kód: M12196035 | rendelési kód: M12196040 | rendelési kód: M12196045 | rendelési kód: M12196060 | rendelési kód: M12196070 |

SERTÉSSÖRTE ECSETEK · CHUNGKING PIG HAIR BRUSHES PINCEAUX EN SOIE DE CHUNGKING

serie
513
series

Kerekített ecset természetes, lakkozott, fenyő színű, rövid fogórésszel és alumínium foglalattal.

Round brush with a natural pine colour varnished long handle, and a seamless aluminium ferrule.

Pinceau rond avec manche long en bois vernis de couleur pin naturel. La virole est en aluminium sans soudure.

NEW
DESIGN!



ÚJ CIKKSZÁM A CSOMAGOLÁSON · NEW CODING PER BAG · NOUVEAU CODAGE POUR POCLETTE

| Serie 513 | 0451302B 513/2 | 0451304B 513/4 | 0451306B 513/6 | 0451308B 513/8 | 0451310B 513/10 | 0451312B 513/12 | 0451314B 513/14 | 0451316B 513/16 |
|-----------|-------------------|-------------------|-------------------|-------------------|--------------------|--------------------|--------------------|--------------------|
| | 3,6mm | 4,3mm | 4,5mm | 6,2mm | 7mm | 7,8mm | 9,9mm | 11mm |
| | 18,3mm | 20,1mm | 21,3mm | 26,4mm | 29,5mm | 31,3mm | 34,4mm | 35,5mm |
| | 280mm | 283mm | 296mm | 308mm | 310mm | 315mm | 327mm | 337mm |
| | 6 units / bag | 6 units | 6 units | 6 units | 6 units | 6 units | 6 units | 6 units |



| Serie 513 | 0451318B 513/18 | 0451320B 513/20 |
|-----------|--------------------|--------------------|
| | 13,3mm | 15,2mm |
| | 38,1mm | 40,4mm |
| | 343mm | 347mm |
| | 6 units | 4 units |



0451306B
513/6

NEW
FORMAT



serie
522
series

Lapos ecset természetes, lakkozott, fenyő színű, hosszú fogórésszel és alumínium foglalattal.

Flat brush with a natural pine colour varnished long handle, and a seamless aluminium ferrule.

Pinceau plat avec manche long en bois vernis de couleur pin naturel. La virole est en aluminium sans soudure.



ÚJ CIKKSZÁM A CSOMAGOLÁSON · NEW CODING PER BAG · NOUVEAU CODAGE POUR POCLETTE

| Serie 522 | 80361B 522/1 | 80362B 522/2 | 80363B 522/3 | 80364B 522/4 | 80365B 522/5 | 80366B 522/6 | 80367B 522/7 | 80368B 522/8 |
|-----------|-----------------|-----------------|-----------------|-----------------|-----------------|-----------------|-----------------|-----------------|
| | 5,2mm | 5,9mm | 6,6mm | 7,9mm | 9,6mm | 10,5mm | 12,2mm | 13,5mm |
| | 1,7mm | 2,4mm | 2,5mm | 3,3mm | 3,3mm | 3,4mm | 4,1mm | 4,2mm |
| | 8,5mm | 10mm | 12,5mm | 15,4mm | 18mm | 19mm | 21mm | 23,8mm |
| | 285mm | 290mm | 295mm | 300mm | 305mm | 310mm | 315mm | 320mm |
| | 6 units / bag | 6 units | 6 units | 6 units | 6 units | 6 units | 6 units | 6 units |



| Serie 522 | 80369B 522/9 | 80370B 522/10 | 80371B 522/11 | 80372B 522/12 |
|-----------|-----------------|------------------|------------------|------------------|
| | 14,1mm | 17mm | 19,8mm | 22mm |
| | 4,6mm | 5,4mm | 5mm | 5,5mm |
| | 24,6mm | 27,7mm | 31,1mm | 33,3mm |
| | 325mm | 330mm | 335mm | 340mm |
| | 6 units | 6 units | 4 units | 4 units |



80366B
522/6

BRUSHES
SET



PG.134



EXPOSITORES
DISPLAYS
PRÉSENTOIRS

PG. 270 >
PG. 271 >

SERTÉSSÖRTE ECSETEK KÉPZŐMŰVÉSZETEKHEZ · CHUNGKING PIG HAIR HANDICRAFT BRUSHES · PINCEAUX EN SOIE DE CHUNGKING TRAVAUX MANUELS

Képzőművészetekhez és dekorációkhoz használatos. A sörték ellenálló képessége és erőssége által sokoldalúan használható különböző technikákra és felületeken.

Suitable for handicrafts and decorating. The resistance of the bristles and their firmness make it very versatile for different techniques and surfaces.

Adapté pour les travaux manuels et la décoration. La résistance de ses poils et leur dureté en font un pinceau très polyvalent, pouvant être employé pour différentes techniques et sur différentes surfaces.

501

serie
501
series

Lapos ecset fekete, lakkozott fa fogórészsel és alumínium foglallattal.

Flat brush with a black varnished wooden handle and a seamless aluminium ferrule.

Pinceau plat avec manche noir en bois et virole en aluminium sans soudure.

BRUSHES
SET



PG.134



ÚJ CIKKSZÁM A CSOMAGOLÁSON · NEW CODING PER BAG · NOUVEAU CODAGE POUR POCLETTE

| Serie 501 | 80329B 501/0 | 80332B 501/2 | 80334B 501/4 | 80336B 501/6 | 80338B 501/8 | 80340B 501/10 | 80375B 501/12 | 80376B 501/14 |
|-----------|-----------------|-----------------|-----------------|-----------------|-----------------|------------------|------------------|------------------|
| | 3,7mm | 4,7mm | 6,2mm | 7mm | 9,1mm | 10,5mm | 12,5mm | 13,7mm |
| | 1,4mm | 2mm | 2,3mm | 2,4mm | 3,7mm | 3,8mm | 4mm | 4,3mm |
| | 8,4mm | 10mm | 13,6mm | 15,3mm | 18,3mm | 21,6mm | 23,4mm | 26mm |
| | 191mm | 195mm | 215mm | 222mm | 240mm | 247mm | 258mm | 267mm |
| | 12 units / bag | 6 units | 6 units | 6 units | 6 units | 6 units | 6 units | 6 units |

rendelési kód: M12172000 rendelési kód: M12172002 rendelési kód: M12172004 rendelési kód: M12172006 rendelési kód: M12172008 rendelési kód: M12172010 rendelési kód: M12172012 rendelési kód: M12172014

| Serie 501 | 80377B 501/16 | 80378B 501/18 | 80379B 501/20 |
|-----------|------------------|------------------|------------------|
| | 14,8mm | 17,5mm | 19,7mm |
| | 4,4mm | 4,4mm | 4,9mm |
| | 28,1mm | 30,1mm | 32,4mm |
| | 273mm | 280mm | 285mm |
| | 4 units | 4 units | 4 units |

rendelési kód: M12172016 rendelési kód: M12172018 rendelési kód: M12172020

80336
501/6



Ecsetek, amelyek a képzőművészetben és a dekorálásban használatos stencil technikákhoz lettek tervezve.

Brushes designed for the stencilling technique in handicrafts and decorating.

Pinceaux conçus pour la technique du pochoir dans le cadre de travaux manuels et de décoration.

20

21

22

serie
20
series

Ecset rövid sörtékkel, alumínium foglallattal és természetes lakkozott fenyő fogórészsel.

Brush with short bristles, with a seamless aluminium ferrule and natural pine colour varnished short wooden handle.

Pinceau à poils courts, avec virole en aluminium sans soudure et manche court en bois vernis de couleur pin naturel.

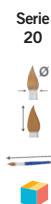
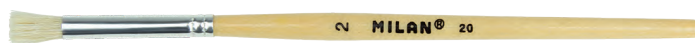

Serie 20

| Serie 20 | 80313B n°2 | 80314B n°4 | 80315B n°6 |
|----------|----------------|---------------|---------------|
| | 5mm | 7mm | 12,4mm |
| | 11,1mm | 13,7mm | 21mm |
| | 145mm | 158mm | 170mm |
| | 12 units / bag | 6 units | 6 units |

rendelési kód: M12190002 rendelési kód: M12190004 rendelési kód: M12190006

80315B
n°6



ÚJ CIKKSZÁM A CSOMAGOLÁSON · NEW CODING PER BAG · NOUVEAU CODAGE POUR POCLETTE

SERTÉSSÖRTE ECSETEK KÉPZŐMŰVÉSZETEKHEZ · CHUNGKING PIG HAIR
HANDICRAFT BRUSHES · PINCEAUX EN SOIE DE CHUNGKING TRAVAUX MANUELS

serie
21
series

Nagy átmérőjű ecset rövid sörtékkel, alumínium foglalattal és rövid, természetes lakkozott fenyő fogórésszel.

Large diameter brush with short bristles, with a seamless aluminium ferrule and natural pine colour varnished short wooden handle.

Pinceau de grand diamètre à poils courts, avec virole en aluminium sans soudure et manche court en bois vernis de couleur pin naturel.



ÚJ
CIKKSZÁM A
CSOMAGOLÁSON
NEW CODING
PER BAG
NOUVEAU
CODAGE POUR
POCHETTE

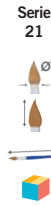

| | |
|--------------------------|--|
| 80316B 21 | |
| 17mm | |
| 24,9mm | |
| 135mm | |
| 3 units / bag | |
| | |
| rendelési kód: M12191021 | |

serie
22
series

Nagy átmérőjű ecset hosszú sörtékkel, alumínium foglalattal és rövid, természetes, lakkozott fenyő fogórésszel.

Large diameter brush with long bristles, with a seamless aluminium ferrule and natural pine colour varnished short wooden handle.

Pinceau de grand diamètre à poils courts, avec virole en aluminium sans soudure et manche court en bois vernis de couleur pin naturel.



ÚJ
CIKKSZÁM A
CSOMAGOLÁSON
NEW CODING
PER BAG
NOUVEAU
CODAGE POUR
POCHETTE

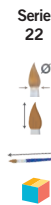

| | |
|--------------------------|--|
| 80317B 22 | |
| 16,6mm | |
| 46,6mm | |
| 155mm | |
| 3 units / bag | |
| | |
| rendelési kód: M12191022 | |

NEW
DESIGN!

NEW
DESIGN!

BLISZTERES ECSETSZETTEK · BRUSHES SET · SET DE PINCEAUX

rendelési kód: M12174K05



serie
101
series

n. 0, 4, 6,
8, 12

27 x 9 x 1 cm · 29 gr

10 units · 0,35 kg

200 units · 7,8 kg

BWM10461



8411574093701

rendelési kód: M12174K03



serie
101
series

n. 2, 8, 12

26,4 x 8,4 x 1 cm · 24,3 gr

10 units · 0,28 kg

200 units · 6,3 kg

BWM10459



8411574093688

rendelési kód: M12178K03



serie
101
series

n. 6, 10, 14

26,4 x 8,4 x 1 cm · 25,8 gr

10 units · 0,31 kg

200 units · 6,9 kg

BWM10460

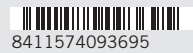

8411574093695

rendelési kód: M12171K03



NEW
DESIGN!

serie
101
series

n. 6, 8, 10

27 x 5 x 0,9 cm · 17 gr

10 units · 0,22 kg

300 units · 7,4 kg

BWM10023



8411574026846

rendelési kód: M12175K04



serie
101
series

n. 4, 10, 16

serie
524
series

n. 8

27 x 9 x 1 cm · 30,9 gr

10 units · 0,37 kg

200 units · 8,1 kg

BWM10462



8411574093718

rendelési kód: M12172K03

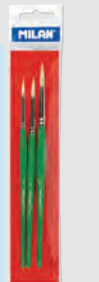

serie
511
series

n. 6, 8, 10

27 x 5 x 1 cm · 24 gr

10 units · 0,28 kg

300 units · 8,8 kg

BWM10024



8411574026853

rendelési kód: M12173K03

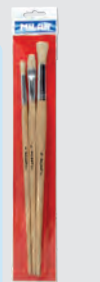

serie
512
series

n. 6, 10

serie
522
series

n. 8

40,5 x 6,2 x 1,5 cm · 68 gr

10 units · 0,76kg

100 units · 8,4 kg

BWM10027



8411574026884

rendelési kód: MIL000772



NEW
DESIGN!

serie
501
series

n. 2, 4, 6

27 x 9 x 5 cm · 16 gr

10 units · 0,20 kg

300 units · 6,8 kg

BWM10485



8411574098997



BLISZTERES ECSETSZETEK · BRUSHES SET · SET DE PINCEAUX

NEW!

rendelési kód: MIL000779



serie
121
series

n. 2, 8, 12

26 x 8,5 x 1 cm · 22,5 gr

10 units · 0,23 kg

200 units · 6 kg

BWM10501



8411574103783

rendelési kód: MIL000780



serie
121
series

n. 6, 10, 14

26 x 8,5 x 1 cm · 25,8 gr

10 units · 0,26 kg

200 units · 6 kg

BWM10502



8411574103790

rendelési kód: MIL000781



serie
121
series

n. 0, 4, 6,
8, 12

26 x 8,5 x 1 cm · 27,5 gr

10 units · 0,28 kg

100 units · 4 kg

BWM10503



8411574103806

rendelési kód: MIL000782



serie
121
series

n. 4, 10, 16

serie
524
series

n. 8

26 x 8,5 x 1 cm · 30 gr

10 units · 0,30 kg

100 units · 4 kg

BWM10504



8411574103813

rendelési kód: MIL000783



serie
121
series

n. 6, 8, 10

26 x 8,5 x 1 cm · 22,5 gr

10 units · 0,23 kg

200 units · 6 kg

BWM10505



8411574103820

rendelési kód: MIL000778



serie
501
series

n. 4, 10, 16

serie
524
series

n. 8

32,5 x 8,2 x 0,5 cm · 40,3 gr

10 units · 0,40 kg

100 units · 5 kg

BWM10500



8411574103776

rendelési kód: MIL000775



serie
501
series

n. 2, 8, 12

32,5 x 8,2 x 0,5 cm · 29,7 gr

10 units · 0,30 kg

200 units · 7 kg

BWM10497



8411574103745

rendelési kód: MIL000776



serie
501
series

n. 6, 10, 14

32,5 x 8,2 x 0,5 cm · 33 gr

10 units · 0,33 kg

100 units · 4 kg

BWM10498



8411574103752

rendelési kód: MIL000777



serie
501
series

n. 0, 4, 6,
8, 12

32,5 x 8,2 x 0,5 cm · 36 gr

10 units · 0,36 kg

200 units · 8 kg

BWM10499



8411574103769

ECSETEK SZINTETIKUS SÖRTÉKKEL · SYNTHETIC HAIR BRUSHES · PINCEAUX EN POILS SYNTHÉTIQUES

serie
301
series

Kerekített ecset sötétkék, lakkozott fogórésszel, krómzott foglalattal. Részletes képzőművészeti alkotásokhoz ajánlott. Rounded brush with a dark blue varnished handle, and a chrome plated seamless ferrule. Suitable for detailed handicrafts work. Pinceau rond avec manche bleu foncé et virole en laiton chromé sans soudure. Adapté pour travailler les petits détails.

NEW
DESIGN!



ÚJ CIKKSZÁM A CSOMAGOLÁSON · NEW CODING PER BAG · NOUVEAU CODAGE POUR POCLETTE

Serie
301

| | 80360B 301 10X0 | 80359B 301 5X0 | 80358B 301 4X0 | 80357B 301 3X0 | 80356B 301 2X0 | 80355B 301X0 |
|---|--------------------------|--------------------------|--------------------------|--------------------------|--------------------------|--------------------------|
| Ø | 1,9mm | 2,2mm | 2,2mm | 2,5mm | 2,6mm | 2,6mm |
| h | 4,4mm | 4,9mm | 5,6mm | 5,7mm | 6,9mm | 7,2mm |
| L | 167mm | 168mm | 169mm | 170mm | 172mm | 173mm |
| U | 12 units / bag | 12 units | 12 units | 12 units | 12 units | 12 units |
| | | | | | | |
| | rendelési kód: M12184010 | rendelési kód: M12184005 | rendelési kód: M12184004 | rendelési kód: M12184003 | rendelési kód: M12184002 | rendelési kód: M12184001 |

NEW
DESIGN!

80358
301 4X0



ECSETEK SZINTETIKUS SÖRTÉKKEL · SYNTHETIC FIBRE BRUSHES · PINCEAUX EN FIBRES SYNTHÉTIQUES

0,1 mm átmérőjű poliészter szálak keveréke halvány aranybarna színben, sötétebb véggel. Sima, puha és ellenálló szintetikus sörték. Vízfestékes és vizes technikákhoz ajánlott. A sörték ellenállásának köszönhetően akril technikákhoz és olajfestményekhez is használatos.

Mixture of polyester filaments 0.1mm in diameter, with a light golden brown colour and darker tip. Smooth, soft and resistant synthetic fibre. Suitable for watercolour and aqueous techniques. The resistance of the bristles also makes them recommended for acrylic and oil techniques.

Mélange de filaments en polyester de 0,1 mm de diamètre, de couleur marron clair doré et avec la pointe plus foncée. Fibre synthétique lisse, souple et résistante. Adaptés pour l'aquarelle et les techniques à l'eau. De par la résistance de leurs poils, ces pinceaux sont également indiqués pour la peinture à l'huile et acrylique.

311 321

serie
311
series

Kerekített ecset rövid, lakkozott, diófa fogórésszel és nikkelezett foglalattal. Rounded brush with a walnut colour varnished short handle and a nickel plated ferrule. Pinceau rond avec manche court en bois vernis de couleur noyer et virole en laiton nickelé.



ÚJ CIKKSZÁM A CSOMAGOLÁSON · NEW CODING PER BAG · NOUVEAU CODAGE POUR POCLETTE

Serie
311

| | 80459B 311/0 | 80461B 311/1 | 80462B 311/2 | 80463B 311/3 | 80464B 311/4 | 80465B 311/5 | 80466B 311/6 | 80467B 311/7 |
|---|--------------------------|--------------------------|--------------------------|--------------------------|--------------------------|--------------------------|--------------------------|--------------------------|
| Ø | 2mm | 2,4mm | 2,6mm | 2,7mm | 3,2mm | 3,5mm | 4,1mm | 4,8mm |
| h | 6,6mm | 8,6mm | 10mm | 12,2mm | 14mm | 15,7mm | 18,2mm | 18,5mm |
| L | 160mm | 165mm | 168mm | 170mm | 173mm | 177mm | 183mm | 186mm |
| U | 12 units / bag | 12 units | 12 units | 12 units | 12 units | 12 units | 12 units | 6 units |
| | | | | | | | | |
| | rendelési kód: M12186000 | rendelési kód: M12186001 | rendelési kód: M12186002 | rendelési kód: M12186003 | rendelési kód: M12186004 | rendelési kód: M12186005 | rendelési kód: M12186006 | rendelési kód: M12186007 |

Serie
311

| | 80468B 311/8 | 80469B 311/9 | 80470B 311/10 | 80471B 311/11 | 80472B 311/12 | 0431114B 311/14 | 0431116B 311/16 | 0431118B 311/18 |
|---|--------------------------|--------------------------|--------------------------|--------------------------|--------------------------|--------------------------|--------------------------|--------------------------|
| Ø | 5mm | 5,4mm | 6mm | 6,8mm | 7,1mm | 7,5mm | 8,2mm | 9,9mm |
| h | 21,5mm | 22,4mm | 25,5mm | 28mm | 28,3mm | 29mm | 29,5mm | 32,7mm |
| L | 190mm | 193mm | 195mm | 202mm | 205mm | 227mm | 229mm | 236mm |
| U | 6 units / bag | 6 units | 6 units | 6 units | 6 units | 6 units | 3 units | 3 units |
| | | | | | | | | |
| | rendelési kód: M12186008 | rendelési kód: M12186009 | rendelési kód: M12186010 | rendelési kód: M12186011 | rendelési kód: M12186012 | rendelési kód: M12186014 | rendelési kód: M12186016 | rendelési kód: M12186018 |

Serie
311

| | 0431120B 311/20 | 0431122B 311/22 | 0431124B 311/24 |
|---|--------------------------|--------------------------|--------------------------|
| Ø | 10,8mm | 12,2mm | 13,1mm |
| h | 34,7mm | 39,5mm | 41,4mm |
| L | 237mm | 240mm | 246mm |
| U | 3 units / bag | 3 units | 3 units |
| | | | |
| | rendelési kód: M12186020 | rendelési kód: M12186022 | rendelési kód: M12186024 |



80466B
311/6

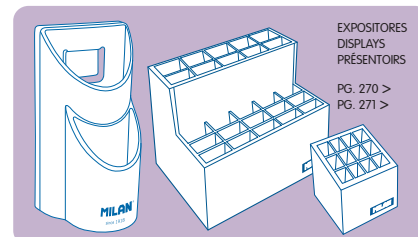

EXPOSITORES
DISPLAYS
PRÉSENTOIRS

PG. 270 >
PG. 271 >

ECSETEK SZINTETIKUS SÖRTÉKKEL · SYNTHETIC FIBRE BRUSHES · PINCEAUX EN FIBRES SYNTHÉTIQUES

serie
321
séries

Lapos ecset rövid, lakkozott, diófa fogórésszel és nikkelezett foglallattal.

Flat brush with a walnut colour varnished short handle with a nickel plated ferrule.

Pinceau plat avec manche court en bois vernis de couleur noyer et virole en laiton nickelé.



ÚJ CIKKSZÁM A CSOMAGOLÁSON · NEW CODING PER BAG · NOUVEAU CODAGE POUR POCHE

| Serie 321 | 80475B 321/2 | 80476B 321/4 | 80477B 321/6 | 80478B 321/8 | 80479B 321/10 | 80480B 321/12 | 80481B 321/14 | 80482B 321/16 |
|-----------|-----------------|-----------------|-----------------|-----------------|------------------|------------------|------------------|------------------|
| | 2,5mm | 4,4mm | 6,6mm | 10mm | 11mm | 12mm | 14,4mm | 18mm |
| | 1,9mm | 2,3mm | 3mm | 3mm | 3,4mm | 4mm | 4,2mm | 19mm |
| | 5,4mm | 8mm | 10,7mm | 11,9mm | 14,4mm | 16,8mm | 17,4mm | 23,8mm |
| | 165mm | 170mm | 175mm | 177mm | 186mm | 190mm | 195mm | 207mm |
| | 12 units / bag | 12 units | 12 units | 6 units | 6 units | 6 units | 3 units | 3 units |



| Serie 321 | 80483B 321/18 | 80484B 321/20 | 0432122B 321/22 | 0432124B 321/24 |
|-----------|------------------|------------------|--------------------|--------------------|
| | 19,6mm | 22mm | 23mm | 24,9mm |
| | 4,6mm | 5mm | 5,6mm | 6mm |
| | 22,5mm | 26mm | 29mm | 32mm |
| | 223mm | 230mm | 246mm | 253mm |
| | 3 units / bag | 3 units | 2 units | 2 units |

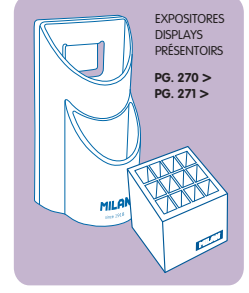

PRÉMIUM SZINTETIKUS ECSETEK

Sima és ellenálló szintetikus szálak. Gyantákhoz és akril felhasználáshoz ajánlott. Sokoldalú és tartós. 0,1 mm-es és 0,07 mm-es poliészter szálak keveréke, vízfestékes és vizes technikákhoz is használatos.

Polyester fibre synthetic hair, smooth and resistant. Recommended for work with resins and acrylics. Highly versatile and durable. Mixture of 0.07 and 0.10mm thick polyester filaments, for watercolour painting and aqueous techniques.

Poils synthétiques en fibres de polyester, souples et résistants. Pinceaux recommandés pour le travail des résines et des liants acryliques. Grande polyvalence et durabilité. Mélange de filaments en polyester de 0,07 et 0,10 mm d'épaisseur, pour l'aquarelle et les techniques à l'eau.

611 621 641

serie
611
series

Kerekített ecset vékony hegygel, fekete, lakkozott fogórésszel és matt ezüst véggel. Nikkelezett foglalat.

Rounded brush with a fine tip, and a black varnished short handle with a matte silver end. Nickel plated tin ferrule.

Pinceau rond avec pointe fine, manche noir court en bois vernis avec l'extrémité argentée mate. Virole en laiton nickelé.



ÚJ CIKKSZÁM A CSOMAGOLÁSON · NEW CODING PER BAG · NOUVEAU CODAGE POUR POCLETTE

Serie
611



| 046112X0B 611/00 | 0461100B 611/0 | 0461102B 611/2 | 0461104B 611/4 | 0461106B 611/6 | 0461108B 611/8 | 0461110B 611/10 | 0461112B 611/12 |
|----------------------------|--------------------------|--------------------------|--------------------------|--------------------------|--------------------------|---------------------------|---------------------------|
| 2,2mm | 2,5mm | 3,2mm | 3,7mm | 4,7mm | 6mm | 6,8mm | 8,4mm |
| 5,7mm | 6,8mm | 10,8mm | 16,6mm | 18,8mm | 22,9mm | 24mm | 30,7mm |
| 163mm | 165mm | 170mm | 180mm | 183mm | 193mm | 196mm | 210mm |
| 6 units / bag | 6 units | 6 units | 6 units | 6 units | 6 units | 6 units | 3 units |

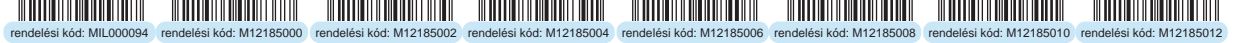

Serie
611



| 0461114B 611/14 | 0461116B 611/16 | 0461118B 611/18 | 0461120B 611/20 | 0461122B 611/22 | 0461124 611/24 |
|---------------------------|---------------------------|---------------------------|---------------------------|---------------------------|--------------------------|
| 9mm | 10,5mm | 10,7mm | 11,8mm | 12,3mm | 13,2mm |
| 33mm | 35,5mm | 36,4mm | 36,6mm | 37,7mm | 40mm |
| 235mm | 240mm | 242mm | 245mm | 250mm | 255mm |
| 3 units / bag | 3 units | 3 units | 3 units | 3 units | 3 unit |



0461106B
611/6



serie
621
series

Lapos ecset rövid, lakkozott, fekete fogórésszel és matt ezüst véggel. Nikkelezett foglalat.

Flat brush with a black varnished short handle and matte silver end. Nickel plated tin ferrule.

Pinceau plat avec manche noir court en bois vernis avec l'extrémité argentée mate. Virole en laiton nickelé.



ÚJ CIKKSZÁM A CSOMAGOLÁSON · NEW CODING PER BAG · NOUVEAU CODAGE POUR POCLETTE

Serie
621



| 046212X0B 621/00 | 0462100B 621/0 | 0462102B 621/2 | 0462104B 621/4 | 0462106B 621/6 | 0462108B 621/8 | 0462110B 621/10 | 0462112B 621/12 |
|----------------------------|--------------------------|--------------------------|--------------------------|--------------------------|--------------------------|---------------------------|---------------------------|
| 3mm | 3,2mm | 3,9mm | 4,4mm | 6mm | 7mm | 10mm | 11mm |
| 1,8mm | 2,2mm | 2,4mm | 2,5mm | 2,7mm | 2,8mm | 3,2mm | 3,6mm |
| 4,6mm | 5,3mm | 7,2mm | 9,3mm | 10,5mm | 12,4mm | 13,5mm | 15,5mm |
| 193mm | 195mm | 197mm | 200mm | 205mm | 210mm | 213mm | 215mm |
| 6 units / bag | 6 units | 6 units | 6 units | 6 units | 6 units | 6 units | 6 units |



Serie
621



| 0462114B 621/14 | 0462116B 621/16 | 0462118B 621/18 | 0462120B 621/20 | 0462122B 621/22 | 0462124B 621/24 |
|---------------------------|---------------------------|---------------------------|---------------------------|---------------------------|---------------------------|
| 14,6mm | 15,8mm | 16,6mm | 18,6mm | 20mm | 23,2mm |
| 4mm | 4,1mm | 4,2mm | 4,9mm | 5,1mm | 5,4mm |
| 16,6mm | 18,2mm | 19,8mm | 19,3mm | 23mm | 24,2mm |
| 218mm | 220mm | 225mm | 230mm | 235mm | 240mm |
| 3 units / bag | 3 units | 4 units | 4 units | 3 units | 3 units |



0462106B
621/6



PRÉMIUM SZINTETIKUS ECSETEK

serie
641
seriés

Macskanyelv ecset rövid, lakkozott, fekete fogórészsel és matt ezüst véggel. Nikkelezett foglalat.

Cat tongue brush with a black varnished short handle and matte silver end. Nickel plated tin ferrule.

Pinceau langue de chat avec manche noir court en bois vernis avec l'extrémité argentée mate. Virole en laiton nickelé.



ÚJ CIKKSZÁM A CSOMAGOLÁSON - NEW CODING PER BAG - NOUVEAU CODAGE POUR POCLETTE

| Serie 641 | 0464120B 641/00 | 0464100B 641/0 | 0464102B 641/2 | 0464104B 641/4 | 0464106B 641/6 | 0464108B 641/8 | 0464110B 641/10 | 0464112B 641/12 |
|-----------|--------------------|-------------------|-------------------|-------------------|-------------------|-------------------|--------------------|--------------------|
| | 2,7mm | 3,5mm | 3,7mm | 4,6mm | 5,5mm | 7mm | 10mm | 10,7mm |
| | 1,6mm | 2mm | 2mm | 2,7mm | 3mm | 3,1mm | 15mm | 4mm |
| | 6mm | 6,4mm | 8mm | 9,8mm | 11,4mm | 13mm | 15mm | 17mm |
| | 193mm | 195mm | 197mm | 200mm | 205mm | 210mm | 213mm | 215mm |
| | 6 units / bag | 6 units | 6 units | 6 units | 6 units | 6 units | 6 units | 6 units |



| Serie 641 | 0464114B 641/14 | 0464116B 641/16 | 0464118B 641/18 |
|-----------|--------------------|--------------------|--------------------|
| | 13,4mm | 14,7mm | 16,7mm |
| | 4mm | 5mm | 5,2mm |
| | 18,1mm | 20,7mm | 24,7mm |
| | 218mm | 220mm | 225mm |
| | 3 units / bag | 3 units | 4 units |



0464106B
641/6



Sima és ellenálló, 0,12 mm-es poliészter szálak keveréke. Olaj- és akrilfestményekhez ajánlott.

Synthetic hair of 0.12 thick polyester fibres, smooth and resistant. Recommended for work with oil and acrylic paints.

Poils synthétiques en fibres en polyester de 0,12mm de grosseur, souples et résistants. Pinceaux recommandés pour le travail à l'huile et la peinture acrylique.



Széles ecset rövid, lakkozott ezüst fogórészsel és matt fekete véggel. Nikkelezett foglalat.

Hátterek és alapok készítéséhez ajánlott bármilyen festési technikában.

Spalter with a silver varnished short handle and matte black end. Nickel plated tin ferrule.

For creating backgrounds and primers with any painting technique.

Pinceau spalter avec manche argenté court en bois vernis et avec l'extrémité en finition noir mate. Virole en laiton nickelé.

Pour la réalisation de fonds et d'enduits avec n'importe quelle technique picturale.

serie
631
seriés

NEW
DESIGN!



| Serie 631 | 0463125 631/25 | 0463135 631/35 | 0463140 631/40 | 0463150 631/50 | 0463160 631/60 | 0463170 631/70 | 0463180 631/80 |
|-----------|-------------------|-------------------|-------------------|-------------------|-------------------|-------------------|-------------------|
| | 25mm | 35mm | 40mm | 50mm | 60mm | 70mm | 80mm |
| | 5,9mm | 6,6mm | 6,6mm | 6,8mm | 7,2mm | 7,2mm | 7,7mm |
| | 25,2mm | 29,5mm | 30,3mm | 34mm | 35mm | 38mm | 38mm |
| | 185mm | 205mm | 210mm | 220mm | 225mm | 227mm | 237mm |
| | 1 unit / bag | 1 unit | 1 unit | 1 unit | 1 unit | 1 unit | 1 unit |



0463135
631/35



NEW
DESIGN!

PRÉMIUM SZINTETIKUS ECSETEK

serie
612
series

Kerekített ecset vékony véggel, hosszú lakkozott fekete fogórészsel és matt ezüst véggel. Nikkelezett foglalat.

Rounded brush with a fine tip, and a black varnished long handle with a matte silver end. Nickel plated tin ferrule.

Pinceau rond avec pointe fine et manche noir long en bois vernis et avec l'extrémité en finition argentée mate. Virole en laiton nickelé.



ÚJ CIKKSZÁM A CSOMAGOLÁSON · NEW CODING PER BAG · NOUVEAU CODAGE POUR POCLETTE

| Serie 612 | 0461200B 612/0 | 0461202B 612/02 | 0461204B 612/04 | 0461206B 612/06 | 0461208B 612/08 | 0461210B 612/10 | 0461212B 612/12 | 0461214B 612/14 |
|-----------|--------------------------|--------------------------|--------------------------|--------------------------|--------------------------|--------------------------|--------------------------|--------------------------|
| | 2,6mm | 3,2mm | 3,6mm | 4,5mm | 6mm | 6,8mm | 8,3mm | 9,3mm |
| | 7mm | 10,7mm | 15,5mm | 18,7mm | 22mm | 25mm | 30mm | 33mm |
| | 275mm | 280mm | 287mm | 293mm | 298mm | 306mm | 318mm | 320mm |
| | 6 units / bag | 6 units | 6 units | 6 units | 6 units | 4 units | 4 units | 6 units |
| | | | | | | | | |
| | rendelési kód: MIL000095 | rendelési kód: MIL000255 | rendelési kód: MIL000096 | rendelési kód: MIL000882 | rendelési kód: MIL000883 | rendelési kód: MIL000259 | rendelési kód: MIL000260 | rendelési kód: MIL000097 |

| Serie 612 | 0461216B 612/16 | 0461218B 612/18 |
|-----------|--------------------------|--------------------------|
| | 10,5mm | 10,5mm |
| | 34,1mm | 35,1mm |
| | 323mm | 325mm |
| | 3 units / bag | 3 units |
| | | |
| | rendelési kód: MIL000098 | rendelési kód: MIL000099 |



0461206B
612/06

serie
642
series

Macskenyelv ecset hosszú lakkozott fekete fogórészsel és matt ezüst véggel. Nikkelezett foglalat.

Cat tongue brush with a black varnished long handle and matte silver end. Nickel plated tin ferrule.

Pinceau langue de chat avec manche noir long en bois vernis et avec l'extrémité en finition argentée mate. Virole en laiton nickelé.

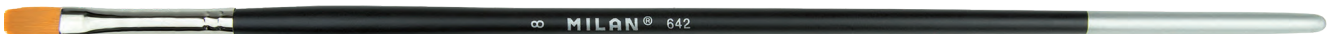

ÚJ CIKKSZÁM A CSOMAGOLÁSON · NEW CODING PER BAG · NOUVEAU CODAGE POUR POCLETTE

| Serie 642 | 0464200B 642/0 | 0464202B 642/2 | 0464204B 642/4 | 0464206B 642/6 | 0464208B 642/8 | 0464210B 642/10 | 0464212B 642/12 | 0464214B 642/14 |
|-----------|--------------------------|--------------------------|--------------------------|--------------------------|--------------------------|--------------------------|--------------------------|--------------------------|
| | 3,5mm | 3,9mm | 4,6mm | 5,5mm | 7,4mm | 9,4mm | 10,8mm | 13mm |
| | 2,2mm | 2,2mm | 2,4mm | 3,3mm | 3,4mm | 3,6mm | 3,7mm | 5mm |
| | 7,4mm | 7,5mm | 10,5mm | 11,1mm | 13,2mm | 14,6mm | 16,9mm | 20,7mm |
| | 193mm | 276mm | 280mm | 284mm | 289mm | 293mm | 297mm | 304mm |
| | 6 units / bag | 6 units | 6 units | 6 units | 6 units | 6 units | 6 units | 3 units |
| | | | | | | | | |
| | rendelési kód: M12188000 | rendelési kód: M12188002 | rendelési kód: M12188004 | rendelési kód: M12188006 | rendelési kód: M12188008 | rendelési kód: M12188010 | rendelési kód: M12188012 | rendelési kód: M12188014 |

| Serie 642 | 0464216B 642/16 | 0464218B 642/18 | 0464220B 642/20 |
|-----------|--------------------------|--------------------------|--------------------------|
| | 15,1mm | 17,8mm | 18mm |
| | 5,2mm | 5,3mm | 5,5mm |
| | 21,9mm | 22,7mm | 23mm |
| | 307mm | 313mm | 317mm |
| | 3 units / bag | 4 units | 4 units |
| | | | |
| | rendelési kód: M12188016 | rendelési kód: MIL000886 | rendelési kód: M12188020 |



0464206B
642/06

PRÉMIUM SZINTETIKUS ECSETEK

serie
622
series

Lapos ecset hosszú lakkozott fekete fogórészsel és matt ezüst véggel. Nikkelezett foglalat. Olaj- és akrilfestményekhez ajánlott. Flat brush with a black varnished long handle and matte silver end. Nickel plated tin ferrule. Intended for oil and acrylic. Pinceau plat avec manche noir long en bois vernis et avec l'extrémité en finition argentée mate. Virole en laiton nickelé.

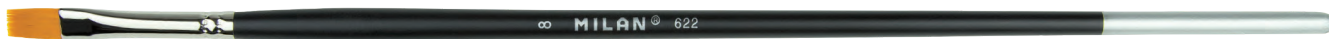

ÚJ CIKKSZÁM A CSOMAGOLÁSON · NEW CODING PER BAG · NOUVEAU CODAGE POUR POCLETTE

| Serie 622 | 0462200B 622/0 | 0462202B 622/2 | 0462204B 622/4 | 0462206B 622/6 | 0462208B 622/8 | 0462210B 622/10 | 0462212B 622/12 | 0462214B 622/14 |
|-----------|--------------------------|--------------------------|--------------------------|--------------------------|--------------------------|--------------------------|--------------------------|--------------------------|
| | 3,5mm | 3,7mm | 4,6mm | 4,9mm | 7,2mm | 10,6mm | 11mm | 14,4mm |
| | 2,1mm | 2,5mm | 2,5mm | 2,8mm | 3mm | 3,3mm | 3,3mm | 4,2mm |
| | 5,8mm | 7,3mm | 9,5mm | 10,5mm | 12,7mm | 13,4mm | 15mm | 16,3mm |
| | 274mm | 274mm | 284mm | 284mm | 286mm | 295mm | 295mm | 295mm |
| | 6 units / bag | 6 units | 6 units | 6 units | 6 units | 6 units | 6 units | 3 units |
| | | | | | | | | |
| | rendelési kód: MIL000114 | rendelési kód: MIL000888 | rendelési kód: MIL000271 | rendelési kód: MIL000889 | rendelési kód: MIL000273 | rendelési kód: MIL000274 | rendelési kód: MIL000275 | rendelési kód: MIL000276 |

| Serie 622 | 0462216B 622/16 | 0462218B 622/18 | 0462220B 622/20 | 0462222B 622/22 | 0462224B 622/24 |
|-----------|--------------------------|--------------------------|--------------------------|--------------------------|--------------------------|
| | 15,9mm | 17,2mm | 18,3mm | 20,1mm | 23,1mm |
| | 4,2mm | 4,2mm | 4,7mm | 5mm | 5mm |
| | 18mm | 19mm | 20mm | 22mm | 24,5mm |
| | 302mm | 305mm | 310mm | 322mm | 322mm |
| | 3 units / bag | 3 units | 3 units | 3 units | 2 units |
| | | | | | |
| | rendelési kód: MIL000277 | rendelési kód: MIL000280 | rendelési kód: MIL000890 | rendelési kód: MIL000115 | rendelési kód: MIL000116 |

0462206B
622/06



PRÉMIUM SZINTETIKUS ECSETEK · SYNTHETIC HAIR BRUSHES PINCEAUX EN POILS SYNTHÉTIQUES

Szintetikus sörté sötétvörös, 0,2 mm-es szintetikus szálaból. Rugalmas és ellenálló szálok, amelyek megtartják formájukat használat után. Vastag festékrétegekhez, akril- és olajfestményekhez ajánlott. Ergonomikus fogórész, hatszögletű felső résszel a még kényelmesebb használatért.

Synthetic hair brushes with, dark reddish brown 0.20 mm thick fibres. Flexible and resistant fibres which maintain their form after use. Intended for thick layers of paint, and thickness, oil and acrylic techniques. Ergonomic handle, with hexagonal upper section, for greater comfort.

Pinceaux en poils synthétiques de 0,20 mm d'épaisseur, de couleur marron foncé rougeâtre. Poils flexibles et résistants qui conservent leur forme même après utilisation. Indiqués pour les couches épaisses de peinture, les techniques d'épaisseurs, la peinture à l'huile et acrylique. Manche ergonomique hexagonal sur la partie supérieure pour un meilleur usage.

822 842



serie
822
series

Lapos ecset hosszú, lakkozott fogórészsel és nikkelezett fogórészsel. Flat brush with a long varnished handle and a nickel plated tin ferrule. Pinceau plat avec manche long en bois vernis et virole en laiton nickelé.



0482206B
822/6



ÚJ CIKKSZÁM A CSOMAGOLÁSON · NEW CODING PER BAG · NOUVEAU CODAGE POUR POCLETTE

| Serie 822 | 0482200B 822/0 | 0482202B 822/2 | 0482204B 822/4 | 0482206B 822/6 | 0482208B 822/8 | 0482210B 822/10 | 0482212B 822/12 | 0482214B 822/14 |
|-----------|--------------------------|--------------------------|--------------------------|--------------------------|--------------------------|--------------------------|--------------------------|--------------------------|
| | 3,6mm | 4,7mm | 5,7mm | 7,3mm | 7,8mm | 10,1mm | 10,5mm | 12,4mm |
| | 2,1mm | 2,6mm | 2,7mm | 3,3mm | 3,5mm | 3,8mm | 4mm | 4,4mm |
| | 6,6mm | 8,9mm | 10,5mm | 14,4mm | 16,3mm | 18mm | 21,1mm | 22,2mm |
| | 286mm | 291mm | 295mm | 301mm | 302mm | 313mm | 318mm | 323mm |
| | 6 units / bag | 6 units | 6 units | 6 units | 6 units | 6 units | 6 units | 6 units |
| | | | | | | | | |
| | rendelési kód: MIL000286 | rendelési kód: MIL000892 | rendelési kód: MIL000893 | rendelési kód: MIL000894 | rendelési kód: MIL000895 | rendelési kód: MIL000291 | rendelési kód: MIL000292 | rendelési kód: MIL000293 |

SZINTETIKUS ECSETEK · SYNTHETIC HAIR BRUSHES PINCEAUX EN POILS SYNTHÉTIQUES

serie
842
series

Macs-kanyelv ecset hosszú, lakkozott fogórészsel és nikkelezett foglalattal.
Cat tongue brush with a long varnished handle and nickel plated tin ferrule.
Pinceau langue de chat avec manche long en bois vernis et virole en laiton nickelé.



0484206B
842/6



ÚJ CIKKSZÁM A CSOMAGOLÁSON · NEW CODING PER BAG · NOUVEAU CODAGE POUR POCLETTE

| Serie 842 | 0484200B 842/0 | 0484202B 842/2 | 0484204B 842/4 | 0484206B 842/6 | 0484208B 842/8 | 0484210B 842/10 | 0484212B 842/12 | 0484214B 842/14 |
|--------------|--------------------------|--------------------------|--------------------------|--------------------------|--------------------------|--------------------------|--------------------------|--------------------------|
| | 3,5mm | 4,5mm | 5,9mm | 6,6mm | 7,6mm | 9,7mm | 10,4mm | 12,2mm |
| | 2mm | 2,4mm | 2,4mm | 3,5mm | 3,6mm | 4,1mm | 4,1mm | 4,2mm |
| | 8,3mm | 10mm | 11,1mm | 14,2mm | 15,6mm | 18mm | 19,4mm | 24,9mm |
| | 286mm | 291mm | 295mm | 301mm | 302mm | 313mm | 318mm | 327mm |
| | 6 units / bag | 6 units | 6 units | 6 units | 6 units | 6 units | 6 units | 6 units |
| | | | | | | | | |
| | rendelési kód: MIL000312 | rendelési kód: MIL000295 | rendelési kód: MIL000298 | rendelési kód: MIL000313 | rendelési kód: MIL000301 | rendelési kód: MIL000314 | rendelési kód: MIL000303 | rendelési kód: MIL000117 |

GONDOSAN VÁLOGATOTT ECSETEK · FINE SELECTION BRUSHES · PINCEAUX FINE SELECTION

Gondosan válogatott 0,07 mm-es poliészter szálak. Extra sima, kiváló alternatíva az ökörfül szőr helyett. A szintetikus szálak ellenállóak, rugalmasak és tartósak. A vizet és a festéket jól tartja, ideális vizes technikákhoz.

Mixture of selected polyester 0.07 mm thick fibres. Extremely smooth fibres, an optimal alternative to natural ox-ear hair.
The synthetic fibre provides resistance, elasticity and durability. Holds the water and paints well, ideal for aqueous techniques.

Poils en différentes fibres de polyester de 0,07 mm de grosseur. Ses poils extrêmement souples représentent une alternative idéale aux poils naturels en oreille de bœuf. La fibre synthétique apporte résistance, élasticité et durabilité. Bonne rétention de l'eau et de la peinture, idéal pour les techniques à l'eau.

711

serie
711
series

Kerekített ecset vékony véggel, rövid, lakkozott világoskék fogórészsel és matt ezüst véggel.
Nikkelezett foglalat.

Rounded brush with a fine tip and a bright blue varnished short handle with a matte silver end.
Nickel plated tin ferrule.

Pinceau rond avec pointe fine. Manche bleu brillant court en bois vernis et avec l'extrémité en finition argentée mate. Virole en laiton nickelé.

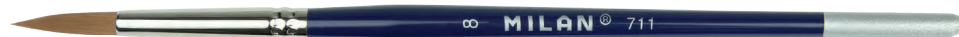

0471106B
711/6



ÚJ CIKKSZÁM A CSOMAGOLÁSON · NEW CODING PER BAG · NOUVEAU CODAGE POUR POCLETTE

| Serie 711 | 047112X0B 711/00 | 0471100B 711/0 | 0471102B 711/2 | 0471104B 711/4 | 0471106B 711/6 | 0471108B 711/8 | 0471110B 711/10 | 0471112B 711/12 | 0471114B 711/14 |
|--------------|--------------------------|--------------------------|--------------------------|--------------------------|--------------------------|--------------------------|--------------------------|--------------------------|--------------------------|
| | 2mm | 2,3mm | 2,8mm | 3,4mm | 4,7mm | 4,9mm | 6,7mm | 7,4mm | 9,1mm |
| | 7mm | 9,8mm | 10,9mm | 14,4mm | 18,6mm | 19,8mm | 24,9mm | 27,8mm | 32,4mm |
| | 160mm | 165mm | 167mm | 175mm | 185mm | 190mm | 220mm | 224mm | 237mm |
| | 6 units / bag | 6 units | 6 units | 6 units | 6 units | 4 units | 6 units | 6 units | 6 units |
| | | | | | | | | | |
| | rendelési kód: M12189P00 | rendelési kód: M12189PP0 | rendelési kód: M12189002 | rendelési kód: M12189004 | rendelési kód: M12189006 | rendelési kód: M12189008 | rendelési kód: M12189010 | rendelési kód: M12189012 | rendelési kód: M12189014 |

"SZIVACS" ECSET · SPONGE "BRUSH" · PINCEAU "ÉPONGE"

Ideális vízfestékes hátterek készítésére és a felület szártására, illetve festékrétegek felvitelére. Ezenfelül képzőművészetekhez is ajánlott, mint például a selyemfestés, dekopázs, famunka és a batik technika. Nem ajánlott lakk munkákhoz.

Suitable for creating watercolour backgrounds and drying the surface, and for applying layers and primers (gesso). Also recommended for handicraft techniques, such as painting on silk, decoupage, work on wood, and the Batik technique. Not recommended for applying lacquer.

Adapté pour la réalisation de fonds en aquarelle et le séchage de la surface ainsi que pour l'application de liants ou d'enduits (gesso). Il est aussi recommandé pour les techniques de travaux manuels comme la peinture sur soie, le découpage, le travail du bois et la technique du Batik. Il n'est toutefois pas conseillé pour l'application de laque.

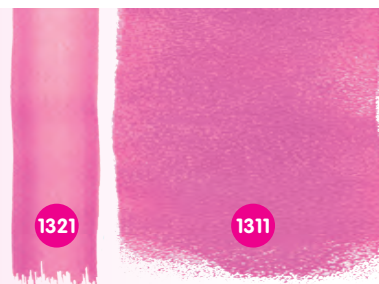

serie 1321
Fekete színű szivacs ecset, lakkozatlan fa fogórészsel.
Black colour sponge brush, with an unvarnished wooden handle.
Pinceau éponge de couleur noire, avec manche en bois non verni.



NEW DESIGN!
04132102
1321/50



NEW DESIGN!

| Serie 1321 | 04132101 1321/25 | 04132102 1321/50 |
|------------|---------------------|---------------------|
| | 25mm | 50mm |
| | 14,1mm | 14,1mm |
| | 151mm | 169mm |
| | 1 unit / bag | 1 unit |

rendelési kód: M12169025 rendelési kód: M12169050

serie 1311
Szivacs ecset kék műanyag fogóval. Vízfestékhez és temperákhoz ajánlott. Hátterek készítéséhez ideális papír-, szövet- és fa felületeken, illetve gravírozható tányérok. Méretek: 0 (sima, 25 mm), 1 (sima, 70 mm), 2 (vízszintes csíkok, 70 mm), 3 (függőleges csíkok, 70 mm) és 4 (négyzetek, 70 mm).

Sponge brush with a blue plastic handle, for applying watercolour and poster paint. Ideal for drawing backgrounds on paper, fabric, wood and engraving plates. 0 (smooth, 25 mm), 1 (smooth 70 mm), 2 (horizontal stripes, 70 mm), 3 (vertical stripes, 70 mm) and 4 (toothed, 70 mm).

Pinceau éponge avec manche en plastique bleu, conçu pour les techniques d'aquarelle et de gouache. Idéal pour la réalisation de fonds sur papier, tissu, bois et planches de gravure. Différentes formes: 0 (lisse, 25 mm), 1 (lisse, 70 mm), 2 (franges horizontales, 70 mm), 3 (franges verticales, 70 mm) et 4 (à dents, 70 mm).



04131102
1311/2



| Serie 1311 | 0413110 1311/0 | 0413111 1311/1 | 0413112 1311/2 | 0413113 1311/3 | 0413114 1311/4 |
|------------|-------------------|-------------------|-------------------|-------------------|-------------------|
| | 25mm | 71,5mm | 69mm | 71mm | 70mm |
| | 37mm | 35mm | 42mm | 43mm | 41mm |
| | 135mm | 140mm | 141mm | 144mm | 147mm |
| | 1 unit / bag | 1 unit | 1 unit | 1 unit | 1 unit |

rendelési kód: M12192000 rendelési kód: M12192001 rendelési kód: M12192002 rendelési kód: M12192003 rendelési kód: M12192004

ÚJRATÖLTHETŐ ECSETOLLAK · REFILLABLE FOUNTAIN WATER BRUSH
 PINCEAU RECHARGEABLE POUR TECHNIQUES HUMIDES

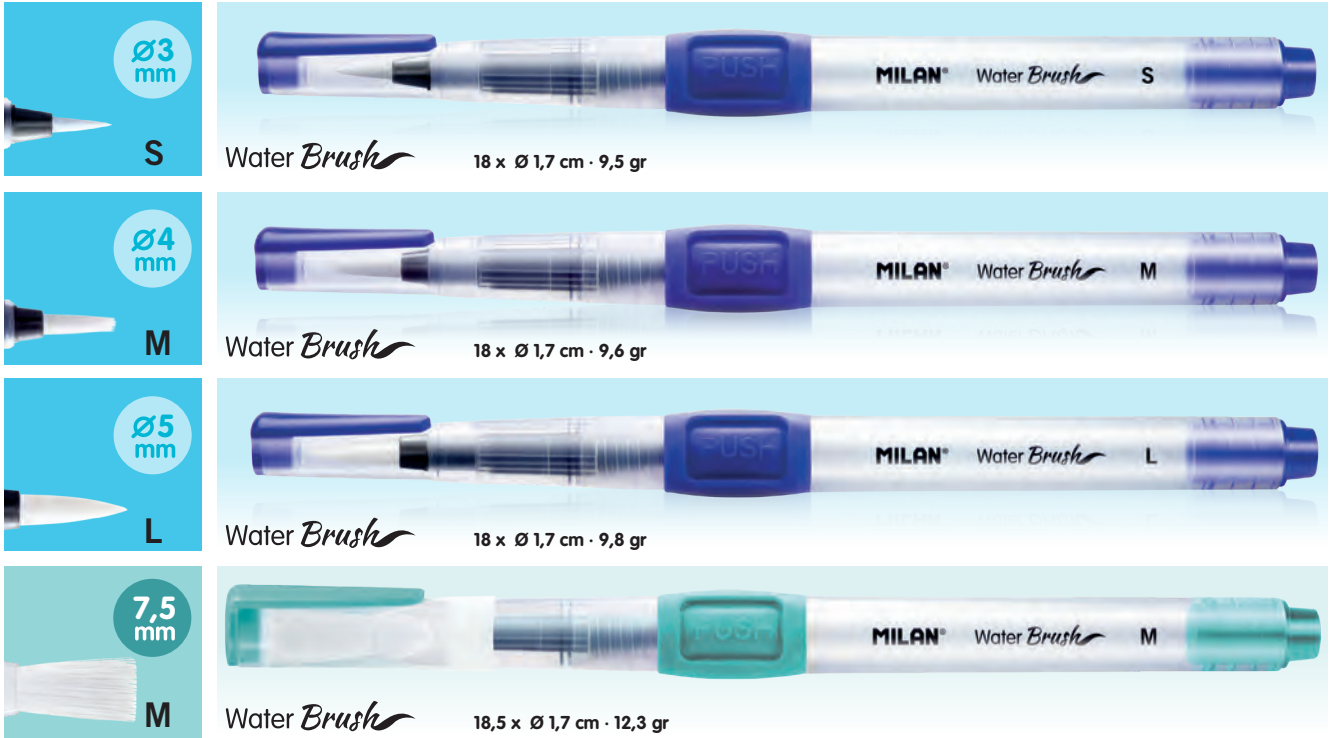

Ecsetollak újratölthető 8 ml-es tartállyal. Vízfestékes-, akril- és tintával történő munkákhoz ajánlott.

Brushes with a refillable water tank of 8 ml. Suitable for watercolour work with pencils, wash drawing or ink and wash.

Pincesaux avec un réservoir d'eau rechargeable de 8ml. Idéaux pour pastilles d'aquarelle, crayons aquarelle, encre ou techniques humides.

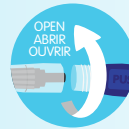

SZINTETIKUS ECSET VÉG.
KÖNNYEN TISZTÍTHATÓ
VÍZZEL.
SYNTHETIC FIBER TIP. EASY
TO WASH WITH WATER.
POINTE EN FIBRE
SYNTHÉTIQUE. FACILE À
LAVER À L'EAU.

HERMETIKUS
KUPAK
HERMETIC CAP
BOUCHON
HERMÉTIQUE

VÍZZEL ÖNTISZTÍTHATÓ
SELF-CLEANING WITH WATER
AUTO LAVABLE A L'EAU

VÍZADAGOLÓ GOMBBAL
WITH LIQUID REGULATION
BUTTON
BOUTON POUSSOIR POUR
RÉGULER LA QUANTITÉ DE
LIQUIDE

ÚJRATÖLTHETŐ ECSETTOLLAK · REFILLABLE FOUNTAIN WATER BRUSH
 PINCEAU RECHARGEABLE POUR TECHNIQUES HUMIDES

rendelési kód: F34179K05



M

+5 BIGlead aquarell

23 x 16 x 1,1 cm · 58 gr

12 units · 0,75 kg

72 units · 5,20 kg

BWM10401



8411574076186

rendelési kód: M12193BL1



M

21 x 6,5 x 1,6 cm · 16,9 gr

24 units · 0,59 kg

BWM10351



8411574062806

rendelési kód: M12193BL3



S
L
M

23,5 x 5 x 1,8 cm · 42 gr

36 units · 1,66 kg

216 units · 10 kg

04C403



8411574096122

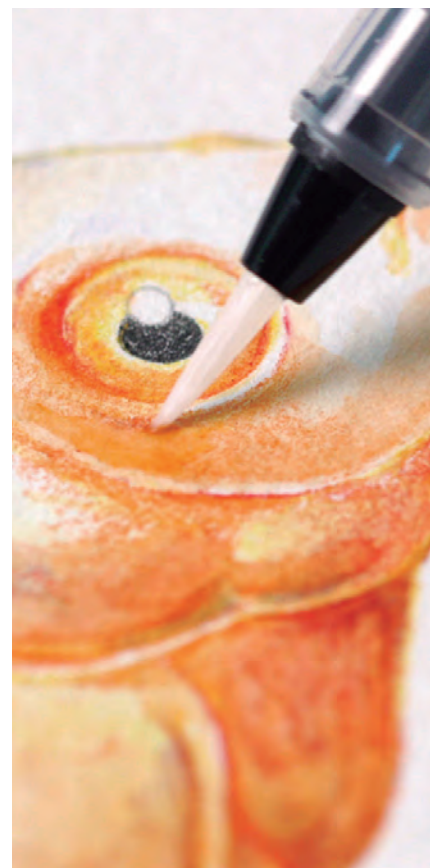

FESTŐ KIEGÉSZÍTŐK · PAINTING ACCESSORIES · ACCESSOIRES DE PEINTURE

ECSETTARTÓ · BRUSH HOLDER · SUPPORT POUR PINCEAUX



21 x 19 x 2,5 cm · 0,12 kg

50 units · 6,60 kg

100 units · 14,3 kg

0400401



8411574073727

49

FÉRŐHELY
SPACES
ESPACES

rendelési kód: M13009000



SZÍNSKÁLA SEGÉDLET · DIDACTIC CIRCLE FOR COLOR MIXTURES CERCLE DIDACTIQUE POUR MÉLANGES DE COULEURS



SZÍNSKÁLA
SEGÉDLET
(SPANYOL)

EDUCATIONAL
COLOUR WHEEL
(SPANISH)

CERCLE
CHROMATIQUE
PÉDAGOGIQUE
(ESPAGNOL)

Segédlet, amely bemutatja, hogy a spektrum színei hogyan származnak a három elsődleges színből.

A teaching tool that shows how the colours of the spectrum are derived from the three primary colours.

Outil pédagogique qui montre comment obtenir la gamme des différentes couleurs à partir des trois couleurs primaires.

31,4 x 25,4 cm · 46 gr

300 units · 14,8 kg

5502



8411574055020

rendelési kód: MIL000001

rendelési kód: M13010500



FESTŐPALETTA
MIXING PALETTE
PALETTE DE
MÉLANGE

20,5 x 14,3 x 0,6 cm · 40 gr

100 units · 4,7 kg

200 units · 9,9 kg

05970



8411574037552

ECSETTÁLAK · POTS · POTS

rendelési kód: M13008000



250
ml

TOP
SELLER

11 x ø 8,8 cm · 54 gr

4 units · 0,26 kg

100 units · 7,6 kg

05951



8411574021216

ECSETTÁL ECSETEK
TISZTÍTÁSÁHOZ
POT FOR CLEANING BRUSHES
POTS POUR NETTOYER
LES PINCEAUX

rendelési kód: M13007000



75
ml

TÉGELY SZÍNEK
KEVERÉSÉHEZ
GLASSES FOR
MIXTURES
POTS POUR
MÉLANGES

20 x 7,3 x 4,3 cm · 44 gr

6 units · 0,36 kg

05953



8411574026822



KÉPZŐMŰVÉSZET ÉS
FEJLESZTŐ JÁTÉKOK

CRAFTS AND
EDUCATIONAL TOYS

LOISIRS CRÉATIFS ET
JOUETS ÉDUCATIFS

TERMÉSZETES GYURMA · NATURAL CLAY · ARGILE NATURELLE

Natural Clay

Égetés nem szükséges.

Akvarell- vagy tempera festékkel színezhető.

Természetes összetevők és tartósítószer.

Használat után helyezze műanyag tárolóba vagy csomagolja nedves textilbe.

Kerámia kemencében égethető (970-1050°C).

No firing needed. Can be painted with acrylic or poster paint.

Natural ingredients and preservatives.

Once opened, wrap with a plastic or damp cloth.

Can be fired in a ceramic kiln (between 970 and 1050°C).

Pas de cuisson nécessaire. Peut être colorée avec de la peinture acrylique ou de la gouache. Ingrédients naturels et conservateurs.

Une fois ouverte, envelopper dans un plastique ou un chiffon humide.

Peut être cuite dans un four céramique (entre 970 et 1050°).

ART



LEVEGŐN SZÁRADÓ
AIR-HARDENING
SÈCHE À L'AIR

TERRACOTTA · TERRACOTTA · TERRE CUITE



rendelési kód: M09074400



400 gr

TERRACOTA
TERRACOTTA
TERRE CUITE

21,1 x 10,8 x 1,3 cm · 0,40 kg

9124428



8411574092681

FEHÉR · WHITE · BLANCHE



rendelési kód: M09073400



400 gr

21,1 x 10,8 x 1,3 cm · 0,40 kg

9124410



8411574092674

HIDEG PORCELÁN · COLD PORCELAIN · PORCELAINE RUSSE

rendelési kód: MIL000223



ART

500 gr

20,5 x 6,5 x 3 cm · 0,50 kg

10 units · 5,25 kg

E4611



8411574715009

Hideg porcelán a magas minőségű formázáshoz. Levegőn száradó, nem szükséges égetés. Lehetővé teszi apró darabok formázását. Dekoratív formák és figurák készítéséhez ajánlott.

Száradási idő: 24/48 óra (a száradási idő a vastagságtól és az időjárási viszonyoktól függ). Bármilyen típusú festékkel színezhető. Porcelánra hasonlító végeredmény.

High definition modeling paste that hardens in air. No cooking required. Allows modeling very thin pieces. It is colored with any type of paint. Allows you to obtain a finish similar to porcelain.

Pâte à modeler haute définition qui durcit à l'air. Aucune cuisson requise. Permet de modeler des pièces très fines. Elle se colore avec tout type de peinture. Permet d'obtenir une finition similaire à la porcelaine.



NAGY RÉSZLETESSÉG
HIGH DEFINITION
HAUTE DÉFINITION



LEVEGŐN SZÁRADÓ
AIR-HARDENING
SÈCHE À L'AIR

MODELLEZŐ GYURMA · MODELLING CLAY · PÂTE À MODELER

rendelési kód: M09071400

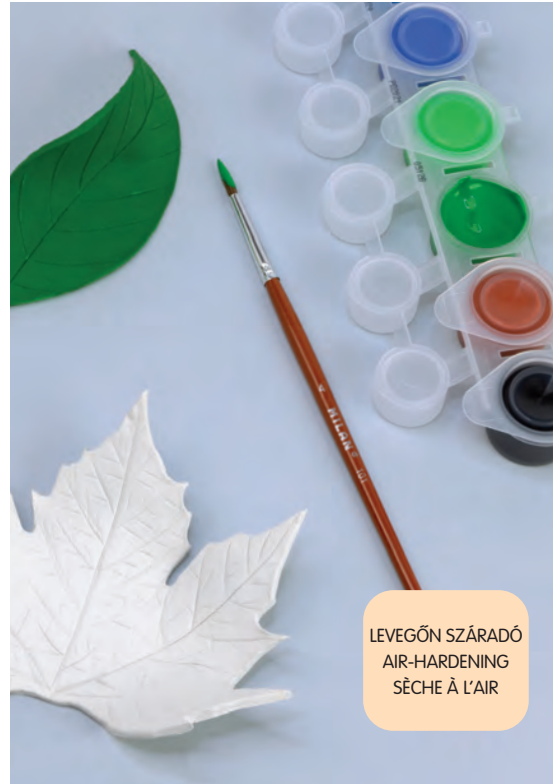

rendelési kód: M09075400



ÁTFESTHETŐ VAGY LAKKOZHATÓ. FORMÁZÁSA VIZES KÉZZEL AJÁNLOTT!
CAN BE PAINTED OVER OR VARNISHED. WET YOUR HANDS BEFORE SHAPING.
PEUT ÊTRE PEINTE OU VERNIE. MOUILLER LES MAINS AVANT DE MODELER.

A Milan modellező gyurma szilárd és tömör. Összegyúrva alakíthatóvá és formázhatóvá válik, és használatra kész. Festhető és lakkozható, kifejezetten képzőművészetekhez ajánlott.

MILAN modeling clay is a solid and compact. Kneading small pieces you obtain a malleable and moldable dough ready to use. It can be painted and varnished and is especially recommended for fine arts.

La pâte à modeler MILAN est un mélange solide et compact. En pétrissant des petits morceaux vous obtenez une pâte malléable et modelable prête à l'emploi. Elle peut être peinte et vernie et est particulièrement recommandée pour les beaux-arts.

BÉLYEGZŐ BLOKK · LINOGRAVURE



| | | |
|----------|---|--|
| S | 7,2 x 11,4 x 0,9 cm · 121 gr 96 units · 11,7 kg | GMM071109 rendelési kód: MIL000242 |
| M | 10 x 14,2 x 0,9 cm · 0,21 kg 48 units · 10,42 kg | GMM101509 rendelési kód: MIL000243 |
| L | 17 x 28 x 0,9 cm · 0,73 kg 16 units · 11,68 kg | GMM153009 rendelési kód: MIL000244 |

VÉSŐ BLOKK MŰVÉSEK SZÁMÁRA



| | | |
|------------|---|--|
| S | 9 x 7 x 0,6 cm · 60 gr 180 units · 10,90 kg | GPM907006 rendelési kód: MIL000227 |
| M | 15 x 9 x 0,6 cm · 124 gr 84 units · 10,72 kg | GPM1509006 rendelési kód: MIL000228 |
| L | 28 x 15 x 0,6 cm · 0,42 kg 24 units · 10,61 kg | GPM2801506 rendelési kód: MIL000229 |
| XL | 30 x 22 x 0,6 cm · 0,68 kg 17 units · 12,45 kg | GPM3002206 rendelési kód: MIL000230 |
| XXL | 30 x 30 x 0,6 cm · 0,87 kg 12 units · 11,74 kg | GPM30030006 rendelési kód: MIL000231 |

GUMI BLOKK



| | | |
|----------|---|---|
| S | 9 x 7,8 x 0,7 cm · 60 gr 180 units · 10,90 kg | GNM90787 rendelési kód: MIL000232 |
| M | 15,5 x 9 x 0,7 cm · 124 gr 84 units · 10,42 kg | GNM155907 rendelési kód: MIL000233 |
| L | 28 x 15,5 x 0,7 cm · 0,42 kg 24 units · 10,61 kg | GNM2801557 rendelési kód: MIL000234 |



ART

LINO METSZŐ KÉSZLET · GOUGES SET · ENSEMBLE DE GOUGES



rendelési kód: G24901K05



10,5 x 3,6 x 3,6 cm · 69 gr

200 units · 15,34 kg

61054

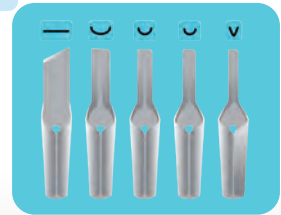

5 VÉSŐFEJES KÉSZLET

Set of 5 gouges for carving.

Ensemble de 5 gouges pour une gravure en relief.

PAPÍR MACHÉ · PAPER PULP POWDER · PAPIER MÂCHÉ EN POUDRE



rendelési kód: MIL000198

3 RÉSZ PAPÍR MACHÉ ÉS 1 RÉSZ VÍZ
3 PARTS POWDER AND 1 PART WATER
3 QUARTS DE POUDRE ET 1 QUART D'EAU

AKRILL- ÉS TEMPERA FESTÉKKEL SZÍNEZHETŐ
CAN BE PAINTED WITH ACRYLIC OR TEMPERA PAINT
À PEINDRE AVEC UNE PEINTURE ACRYLIQUE OU GOUACHE



200 gr

LEVEGŐN SZÁRADÓ
AIR-HARDENING
SÈCHE À L'AIR

GLUTÉNMENTES
GLUTEN FREE
SANS GLUTEN

31,5 x 21 x 8 cm · 210 gr

12 units · 3,3 kg

91842



A 200 GRAMMOS CSOMAGBÓL NÉGY DARAB Ø 15 CM-ES BOLYGÓ KÉSZÍTHETŐ
WITH THIS 200G BAG, FOUR Ø 15cm PLANETS CAN BE MADE.
AVEC CE SACHET DE 200G, VOUS POUVEZ FAIRE 4 PLANÈTES DE Ø 15cm.

KINEKTIKUS HOMOK ÉS FORMÁK · KINETIC SAND KIT WITH MOLDS KIT
DE SABLE MAGIQUE AVEC MOULES

rendelési kód: M09122012



CRAB & CO.

453 gr

23 x 18,5 x 4 cm · 0,56 kg
6 units · 3,62 kg

917545

8411574102014



NÉZD MEG A VIDEÓT

SOHA NEM SZÁRAD KI
IT NEVER DRIES
NE SÈCHE JAMAIS

SÓ-LISZT MODELLEZŐ GYURMA · WHEAT FLOUR BASED MODELLING DOUGH ·
PÂTE À MODELER À BASE DE FARINE DE BLÉ



NÖVÉNYI ALAPANYAGOKBÓL
VEGETABLE ORIGIN COMPONENTS
COMPOSANTS D'ORIGINE VEGETALE



4 unidades/cajita
units/box
unités/boîte

25,5 x 7,8 x 6,5 cm · 0,55 kg

12 units · 7 kg



- 9135111004
rendelési kód: MIL000060
- 9135112004
rendelési kód: MIL000061
- 9135113204
rendelési kód: MIL000064
- 9135113004
rendelési kód: MIL000062
- 9135113304
rendelési kód: MIL000065
- 9135114004
rendelési kód: MIL000066
- 9135115204
rendelési kód: MIL000068
- 9135114704
rendelési kód: MIL000067
- 9135116004
rendelési kód: MIL000069
- 9135118004
rendelési kód: MIL000070

DISPLAY · DISPLAY · PRÉSENTOIR

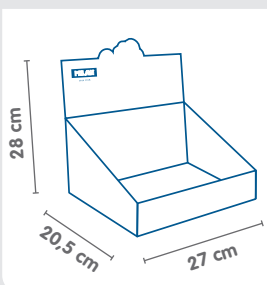

KAPACITÁS · CAPACITY · CAPACITÉ

24 u.
116 gr - 4.1 oz

80 x 72 x 0,2 cm · 0,12 kg

ZVM10249

8411574100959

HALMOZHATÓ ÜRES DISPLAY
MOUNTABLE EMPTY DISPLAY
PRÉSENTOIR VIDE, À MONTER

KIHELYEZÉSI JAVASLAT
PRESENTATION SUGGESTION
SUGGESTION DE PRÉSENTATION

SÓ-LISZT MODELLEZŐ GYURMA · WHEAT FLOUR BASED MODELLING DOUGH ·
PÂTE À MODELER À BASE DE FARINE DE BLÉ

rendelési kód: M09072085



KEVERHETŐ
SZÍNEK
MIXABLE COLOURS
COULEURS
MÉLANGEABLES

ALAP
SZÍNEK

LÉPÉSRŐL LÉPÉSRE
STEP BY STEP
PAS À PAS



10
unidades/cajita
units/box
unités/boîte

33 x 13,8 x 6,8 cm · 1,12 kg

6 units · 7,10 kg

913510B 8411574086567



X10
85 gr - 3 oz



rendelési kód: MIL000209



LÉPÉSRŐL LÉPÉSRE
STEP BY STEP
PAS À PAS

NEON
SZÍNEK



35,3 x 8,5 x 7,4 cm · 0,89 kg

6 units · 5,70 kg

913505N 8411574086543

5
u./cajita
u./box
u./boîte



X5
142 gr - 5 oz



SÓ-LISZT MODELLEZŐ GYURMA · WHEAT FLOUR BASED MODELLING DOUGH · PÂTE À MODELER À BASE DE FARINE DE BLÉ

rendelési kód: MIL000207



16
30 gr - 1.05 oz



ALAP SZÍNEK

NEON SZÍNEK

GLITTERES SZÍNEK



22 x 23 x 3,7 cm · 0,708 kg

6 units · 4,6 kg

913316SC



8411574094029

16

u./cajita
u./box
u./boite



LÉPÉSRŐL LÉPÉSRE
STEP BY STEP
PAS À PAS



SÓ-LISZT MODELLEZŐ GYURMA FORMÁZÓ KÉSZLETTEL
WHEAT FLOUR BASED MODELLING CLAY KITS WITH TOOLS
COFFRETS DE PÂTE À MODELER À BASE FARINE DE BLÉ AVEC OUTILS

rendelési kód: MIL000208



TARTALOM · CONTENT · CONTENU



4
116 gr - 4.1 oz

BASIC COLOURS



29 FORMA
29 TOOLS
29 OUTILS



30,5 x 22 x 8,2 cm · 0,90 kg

6 units · 6,1 kg

913304HF



8411574093992

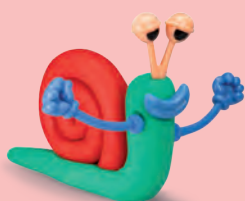

NÉZD MEG A
VIDÉÓT!

SÓ-LISZT MODELLEZŐ GYURMA FORMÁZÓ KÉSZLETTEL
 WHEAT FLOUR BASED MODELLING CLAY KITS WITH TOOLS
 COFFRETS DE PÂTE À MODELER À BASE FARINE DE BLÉ AVEC OUTILS

rendelési kód: MIL000478

TARTALOM · CONTENT · CONTENU



4
116 gr - 4.1 oz

BASIC COLOURS



12 ESZKÖZ
12 TOOLS
12 OUTILS



30,5 x 22 x 8,2 cm · 1,10 kg

6 units · 6,10 kg

913304HB

8411574097952

rendelési kód: MIL000226

TARTALOM · CONTENT · CONTENU



6
59 gr - 2.1 oz

BASIC COLOURS



10 ESZKÖZ
10 TOOLS
10 OUTILS



30,5 x 22 x 6,2 cm · 0,80 kg

6 units · 4,9 kg

9133061CW

8411574094005



SÓ-LISZT MODELLEZŐ GYURMA FORMÁZÓ KÉSZLETTEL
WHEAT FLOUR BASED MODELLING CLAY KITS WITH TOOLS
COFFRETS DE PÂTE À MODELER À BASE FARINE DE BLÉ AVEC OUTILS

rendelési kód: MIL000222



TARTALOM · CONTENT · CONTENU

8
59 gr - 2.1 oz

BASIC COLOURS



10 ESZKÖZ
10 TOOLS
10 OUTILS



30,5 x 22 x 6,2 cm · 0,90 kg

6 units · 5,8 kg

913308CT

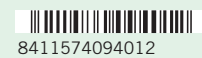

8411574094012

rendelési kód: MIL000199



TARTALOM · CONTENT · CONTENU

8
59 gr - 2.1 oz

BASIC COLOURS



18 ESZKÖZ
18 TOOLS
18 OUTILS



30,5 x 22 x 6,2 cm · 0,85 kg

6 units · 5,70 kg

913308BBQ



8411574104629



NÉZD MEG A
VIDEÓT!

SÓ-LISZT MODELLEZŐ GYURMA FORMÁZÓ KÉSZLETTEL
 WHEAT FLOUR BASED MODELLING CLAY KITS WITH TOOLS
 COFFRETS DE PÂTE À MODELER À BASE FARINE DE BLÉ AVEC OUTILS

rendelési kód: MIL000479

TARTALOM · CONTENT · CONTENU

MILAN since 1918
Soft Dough 3+
LETTERS
 KIT DE PASTA BLANCA A BASE DE TRIGO CON HERRAMIENTAS WHEAT-BASED MODELLING CLAY KIT WITH TOOLS
 KIT DE PÂTE À MODELER À BASE DE BLÉ AVEC OUTILS
 WHEAT-FLOUR BASED MODELLING CLAY KIT WITH TOOLS
 X8 19 gr 2.1 oz

MILAN Soft Dough
 8 59 gr - 2.1 oz
 BASIC COLOURS
 NEON COLOURS

29 ESZKÖZ
 29 TOOLS
 29 OUTILS

LOTS OF LETTERS

30,5 x 22 x 6,2 cm · 1 kg
 6 units · 5,5 kg
913308LL
 8411574097969

rendelési kód: MIL000200

TARTALOM · CONTENT · CONTENU

MILAN since 1918
Soft Dough 3+
NUMBERS
 KIT DE PASTA BLANCA A BASE DE TRIGO CON HERRAMIENTAS WHEAT-BASED MODELLING CLAY KIT WITH TOOLS
 KIT DE PÂTE À MODELER À BASE DE BLÉ AVEC OUTILS
 WHEAT-FLOUR BASED MODELLING CLAY KIT WITH TOOLS
 X8 19 gr 2.1 oz

MILAN Soft Dough
 8 59 gr - 2.1 oz
 BASIC COLOURS

18 ESZKÖZ
 18 TOOLS
 18 OUTILS

LOTS OF NUMBERS

30,5 x 22 x 6,2 cm · 0,85 kg
 6 units · 5,70 kg
913308NM
 8411574104612



NÉZDE MEG A VIDEÓT

KUKORICAKEMÉNYÍTŐ MODELLEZŐ GYURMA · MODELLING CLAY MADE OF CORN STARCH PÂTE À MODELER À BASE D'AMIDON DE MAÏS

rendelési kód: M09072070

NEW!

PASTEL COLOURS

70 gr

6 SZÍN
6 BARRITAS
6 SZÍN
6 BARS
6 COULEURS
6 BARRES

18 x 11 x 1,5 cm · 74 gr
96 units · 8,6 kg

914706P 8411574106012

LÉPÉSRŐL LÉPÉSRE | STEP BY STEP | PAS À PAS



rendelési kód: MIL000194

BASIC COLOURS

330 gr

17,4 x 12,4 x 2,1 cm · 334 gr
24 units · 9,2 kg

914504 8411574098942

4 SZÍN
8 DARAB
4 COLOURS
8 BARS
4 COULEURS
8 BARRES

LÉPÉSRŐL LÉPÉSRE | STEP BY STEP | PAS À PAS

rendelési kód: MIL000196

BASIC COLOURS

140 gr

18,5 x 18 x 1,5 cm · 147 gr
48 units · 8,4 kg

914712 8411574098935

12 SZÍN
12 DARAB
12 COLOURS
12 BARS
12 COULEURS
12 BARRES

LÉPÉSRŐL LÉPÉSRE | STEP BY STEP | PAS À PAS

rendelési kód: MIL000197

NEON COLOURS

70 gr

18 x 11 x 1,5 cm · 74 gr
96 units · 8,6 kg

914706N 8411574098928

6 SZÍN
6 DARAB
6 COLOURS
6 BARS
6 COULEURS
6 BARRES

LÉPÉSRŐL LÉPÉSRE | STEP BY STEP | PAS À PAS

GLUTÉNMENTES · GLUTEN FREE · SANS GLUTEN

NEM SZÁRADÓ
NO DRIES
NE SÈCHE PAS

KEVERHETŐ SZÍNEK
MIXABLE COLOURS
COULEURS MÉLANGEABLES

KÖNNYEN
FORMÁZHATÓ
EASY TO MOULD
FACILE À MODELER

KUKORICAKEMÉNYÍTŐ MODELLEZŐ GYURMA FORMÁZÓ KÉSZLETTEL ·
 MODELLING CLAY KIT MADE OF CORN STARCH WITH TOOLS · COFFRET DE PATE A
 MODELER A BASE D'AMIDON DE MAÏS AVEC OUTILS

rendelési kód: M09072K12

NEW!

WILD LIFE

TARTALOM
CONTENT
CONTENU

16

NEON SZÍN

ALAP SZÍNEK

22,5 x 21 x 6 cm · 390 gr

6 units · 4 kg

914312

8411574106005



FORMÁZÓ KÉSZLET · MODELLING TOOLS OUTILS POUR LE MODELAGE

rendelési kód: MIL000211



17 x 10 x 1,4 cm · 34 gr

12 units · 0,44 kg

72 units · 2,7 kg

9194110



8411574090441

VEGYES SZÍNEK



KÉTVÉGŰ, ERGONOMIKUS FOGÓRÉSZ
DOUBLE ENDED ERGONOMIC HANDLE. MANCHE
ERGONOMIQUE AVEC DOUBLE POINTE.



KÉTVÉGŰ, GYURMANYÚJTÓ HENGER
DOUBLE ENDED HANDLE/ROLLER.
MANCHE/ROULEAU AVEC DOUBLE POINTE.



PRECÍZIÓS ESZKÖZÖK A
RÉSZLETEKHEZ ÉS TEXTÚRÁKHOZ
PRECISION TOOLS FOR DETAILS
AND TEXTURES.
POINTES DE PRÉCISION POUR LES
DÉTAILS ET LES TEXTURES.



1 ÉS 1,5 CM-ES GÖMBÖK
SIMÍTÁSHOZ ÉS ILLESZTÉSHEZ
BALLS OF \varnothing 1cm AND \varnothing 1.5cm FOR
SMOOTHING AND ADHESION.
BILLES DE \varnothing 1 cm ET \varnothing 1,5 cm
POUR LE POLISSAGE ET LE
COLLAGE.



ESZKÖZ SIMÍTÁSHOZ ÉS
ILLESZTÉSHEZ GÖRBE
TERÜLETEKEN
TOOL FOR SMOOTHING
AND ADHESION OF CURVED
AREAS.
OUTIL POUR LE POLISSAGE ET LE
COLLAGE DES ZONES COURBES.



VÁGÓESZKÖZ
CUTTING TOOL.
OUTIL DE DÉCOUPE.



SPATULA SIMÍTÁSHOZ ÉS
ILLESZTÉSHEZ
SPATULAS FOR SMOOTHING
AND ADHESION.
SPATULES POUR LE
POLISSAGE ET LE COLLAGE.



ModellingTools

FÁBÓL KÉSZÜLT FEJLESZTŐ JÁTÉKOK · WOODEN EDUCATIONAL TOYS
 JOUETS EDUCATIFS EN BOIS



rendelési kód: C25002640

13,5 x 13,5 x 14 cm · 0,83 kg

6 units · 4,98 kg

660505

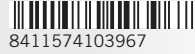

8411574103967

WOODEN TOYS



FÁBÓL KÉSZÜLT FEJLESZTŐ JÁTÉKOK · WOODEN EDUCATIONAL TOYS
JOUETS EDUCATIFS EN BOIS

ANIMAL TOWERS

rendelési kód: C25002641

26,5 x 17 x 8,5 cm · 0,96 kg
6 units · 5,76 kg

660515
8411574103981

WOODEN TOYS

15 PIECES
+12m
AGE
WOOD
+1
PLAYERS



FÁBÓL KÉSZÜLT FEJLESZTŐ JÁTÉKOK · WOODEN EDUCATIONAL TOYS
 JOUETS EDUCATIFS EN BOIS



rendelési kód: C25002642



32,5 x 14 x 4,5 cm · 0,63 kg

6 units · 3,78 kg

660510



8411574103974

WOODEN TOYS



20 PIECES



+36m
AGE



WOOD



1-6
PLAYERS





FÁBÓL KÉSZÜLT FEJLESZTŐ JÁTÉKOK · WOODEN EDUCATIONAL TOYS
 JOUETS EDUCATIFS EN BOIS

ALIENS TOWER



32,5 x 14 x 4,5 cm · 0,59 kg

6 units · 3,54 kg

660520



8411574103998

WOODEN TOYS



76 PIECES



+36m
AGE



WOOD



1-6
PLAYERS



KÜLÖNBÖZŐ NEHÉZSÉGI SZINTEK
 DIFFERENT LEVELS OF DIFFICULTY
 DIFFÉRENTS NIVEAUX DE DIFFICULTÉ



**HÁROMSZÖG VONALZÓK · TRIANGULAR RULERS GRADUATED IN CENTIMETERS ·
RÈGLES TRIANGULAIRES GRADUÉES EN CENTIMÈTRES**

rendelési kód: F43182N15

60

u./cajita
u./box
u./boîte



18 x 10 x 4 cm · 0,65 kg

21 units · 14 kg

351260LK2



8411574093022

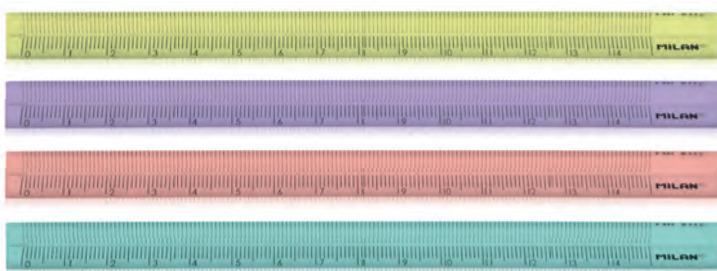

17 x 1 x 1 cm · 9,7 gr

15 cm

cm



31,9 x 1 x 1 cm · 17 gr

30 cm

cm



TRIRULER

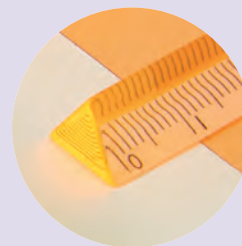

rendelési kód: F43182N30

30 cm

39,9 x 5,4 x 1 cm · 33 gr

50 units · 1,68 kg

100 units · 3,93 kg

BWM10511RN



8411574104483

CM ÉS INCH BEOSZTÁSÚ VONALZÓK · CENTIMETERS AND INCHES GRADUATED RULERS · RÈGLES GRADUÉES EN CENTIMÈTRES ET POUÇES



22 x 3,7 x 1 cm · 18,2 gr **20 cm** cm & INCHES

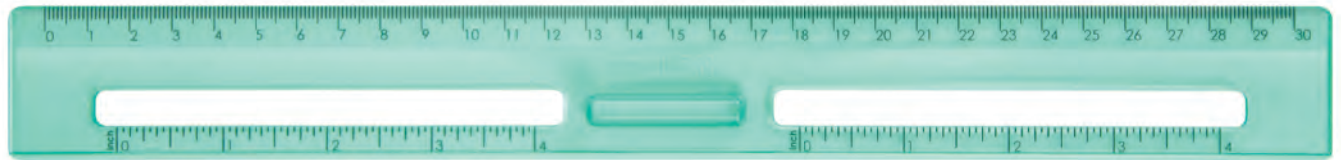

32 x 3,7 x 1 cm · 25,4 gr **30 cm** cm & INCHES

ÖSSZEILLESZTHETŐEK. 4 AZ 1-BEN
YOU CAN COUPLE THEM. 4 IN 1
PEUVENT S'EMBOÏTER. 4 EN 1

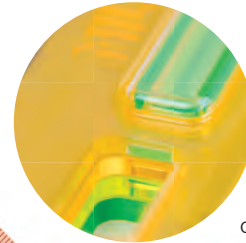

ÖSSZEILLESZTVE EGY KOMPAKT CSOMAGOT ALKOT
COUPLED FORMING A COMPACT PACK
S'EMBOÏTENT POUR FORMER UN ENSEMBLE COMPACT



32 x 11,4 x 1,2 cm · 88,3 gr cm & INCHES

rendelési kód: F43185020

20 cm

27 x 5,5 x 1 cm · 19,9 gr

24 units · 0.53 kg

288 units · 6.80 kg

357801NL

8411574100768

rendelési kód: F43185030

30 cm

37 x 5,5 x 1 cm · 27,1 gr

24 units · 0.71 kg

288 units · 9.12 kg

353801NL

8411574100775

rendelési kód: F43185KLO

359801NL

38 x 16 x 1,4 cm · 157,1 gr

24 units · 3.99 kg

72 units · 12.62 kg

8411574100782

KÉSZLET TARTALMA:

- 30 CM-ES VONALZÓ
- 90°/45°/45° VONALZÓ
- 90°/60°/30° VONALZÓ
- 180°/10cm SZÖGMÉRŐ

Tracing kit:

- 30cm ruler
- Set square 90°/45°/45°
- Set square 90°/60°/30°
- Protractor 180°/10cm

Kit de traçage:

- Une règle de 30cm
- Une équerre 90°/45°/45°
- Une équerre 90°/60°/30°
- Un rapporteur 180°/10cm

CM ÉS INCH BEOSZTÁSÚ VONALZÓK · CENTIMETERS AND INCHES GRADUATED RULERS · RÈGLES GRADUÉES EN CENTIMÈTRES ET POUÇES





RADÍRRAL
ERASER
GOMME À
EFFACER

PATENTED DESIGN

17 x 1 x 1 cm · 36,1 gr

15 cm
6"

cm & INCHES

rendelési kód: MIL000813



x1 PÓTRADÍR
SPARE ERASERS
GOMMES DE RECHANGE

21,2 x 6,3 x 1,2 cm · 30 gr

12 units · 0,41 kg

96 units · 3,60 kg

BYM10347



8411574060222

10

u./cajita
u./box
u./boîte

rendelési kód: F43183015



16 x 12 x 2,5 cm · 0,39 kg

6 units · 2,47 kg

24 units · 10,10 kg

352910



8411574048343

HÁROMSZÖG VONALZÓK · TRIANGULAR RULERS GRADUATED IN CENTIMETERS · RÈGLES TRIANGULAIRES GRADUÉES EN CENTIMÈTRES

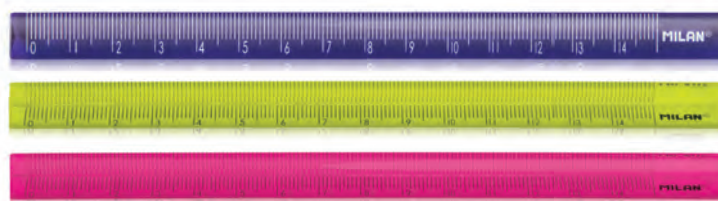
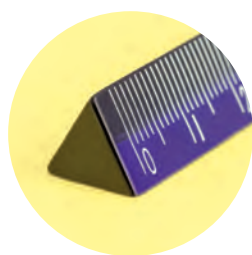

17 x 1 x 1 cm · 9,7 gr 15 cm cm



rendelési kód: F43182C15

60 unidades/cajita
units/box
unités/boîte

18 x 10 x 4 cm · 0,65 kg

21 units · 14 kg

351260C



8411574080312





FLEXIBILIS VONALZÓK

TRANSLUCENT FLAT & FLEXIBLE RULERS GRADUATED IN CENTIMETERS RÈGLES
TRANSLUCIDES PLATES ET FLEXIBLES GRADUÉES EN CENTIMÈTRES

rendelési kód: F43184103



flex & RESISTANT



30 cm cm

38,2 x 5 x 0,3 cm · 24 gr
24 units · 0,65 kg
288 units · 8,20 kg

353801



8411574064695

rendelési kód: F43184550



acid SERIES

30 cm cm

353801Y



8411574078890

rendelési kód: F43184661



NÉZD MEG A VIDEÓT!



ÁTTETSZŐ TRANSLUCENT TRANSLUCIDES

30 cm cm

353801P



8411574072645

FLEXIBILIS VONALZÓKÉSZLET · TRACING KIT · KIT DE TRAÇAGE

MILAN **flex & RESISTANT**

KIT DE TRAZADO: regla, escuadra, cartabón y transportador
TRACING KIT: ruler, 45° set square, 45° set square and protractor



rendelési kód: F43184K103

NEW DESIGN!

34,4 x 18,5 x 0,3 cm · 106 gr
24 units · 2,70 kg
96 units · 11,40 kg

359801



8411574064701

MILAN **flex & RESISTANT**

KIT DE TRAZADO: regla, escuadra, cartabón y transportador
TRACING KIT: ruler, 45° set square, 45° set square and protractor



rendelési kód: F43184K550

NEW DESIGN!

34,4 x 18,5 x 0,3 cm · 106 gr
24 units · 2,70 kg
96 units · 11,40 kg

359801Y



8411574078906

MILAN **flex & RESISTANT**

KIT DE TRAZADO: regla, escuadra, cartabón y transportador
TRACING KIT: ruler, 45° set square, 45° set square and protractor



rendelési kód: F43184K661

NEW DESIGN!

34,4 x 18,5 x 0,3 cm · 106 gr
24 units · 2,70 kg
96 units · 11,40 kg

359801P



8411574072652

CM ÉS INCH BEOSZTÁSÚ VONALZÓ
FLAT RULER GRADUATED IN CENTIMETERS AND INCHES
RÈGLE PLATE GRADUÉE EN CENTIMÈTRES ET POUÇES



31,6 x 3,6 x 0,4 cm · 23,5 gr

30 cm
12"

cm & INCHES

NEW!



rendelési kód: F43184200

30 cm 12 inch

38,4 x 5 x 0,3 cm · 25 gr

24 units · 0,64kg

288 units · 8,1 kg

353801DWZ

8411574102984



KÖRZŐ

BOW COMPASS WITH AUTOMATIC ADJUSTMENT

COMPAS À RÉGLAGE AUTOMATIQUE

GYORSAN NYITHATÓ.
ÁLLANDÓ PRECIZITÁS ÉS MINŐSÉG
ÁLLÍTHATÓ: 12 CM

Fast open compass.
 Precision and quality.
 Unrestricted self-centring. 12cm.
 Articulated joints.

Compas automatique à
 ouverture rapide.
 Précision et qualité.
 Autocentrage illimité. 12 cm.
 Branches articulées.



**TARTALMAZ HOSSZABBÍTÓT, EGY
 ADAPTERT MŰSZAKI JEJELŐKHOZ
 ÉS PÖTBELEKET**

INCLUDES EXTENSION, AN ADAPTER FOR
 TECHNICAL MARKERS AND SPARE LEADS

INCLUT UN RALLONGE, UN ADAPTATEUR
 POUR LES FEUTRES TECHNIQUES ET MINES
 DE RECHARGE

rendelési kód: MIL000020



20 x 7,5 x 2 cm - 0,17 kg

80 units - 14 kg

80050



8411574800507

KÖRZŐ · COMPASS · COMPAS

rendelési kód: MIL000245



16,5 x 4,5 x 1,8 cm - 63 gr

12 units - 0,81 kg

144 units - 10,22 kg

11101B



8411574101659



**TARTALOM: körző, bővítő kiegészítés,
 műszaki kiegészítők és pöttyél.**
 INCLUDES AN ADAPTER FOR TECHNICAL
 MARKERS AND SPARE LEADS
 INCLUT UN ADAPTATEUR POUR LES
 FEUTRES TECHNIQUES ET MINES DE
 RECHARGE



rendelési kód: MIL000246



16,5 x 4,5 x 1,8 cm - 63 gr

12 units - 0,81 kg

144 units - 10,22 kg

11101P



8411574101666



KREATÍV OLLÓK CSERÉLHETŐ VÁGÓÉLLEL
ZIGZAG SCISSORS WITH INTERCHANGEABLE BLADES WITH DIFFERENT PROFILES
CISEAUX POUR DÉCOUPE EN ZIG-ZAG AVEC LAMES INTERCHANGEABLES DE DIFFÉRENTS PROFILS

rendelési kód: G19175001



A VÁGÓFEJ NEM CSERÉLHETŐ
NON INTERCHANGEABLE BLADES
LAMES NON INTERCHANGEABLES

21 x 9 x 2 cm · 55 gr

12 units · 0,73 kg

240 units · 15,30 kg

14930901



8411574076391

rendelési kód: G19175144



4 CSERÉLHETŐ VÁGÓFEJ
INTERCHANGEABLE BLADES
LAMES INTERCHANGEABLES

24 x 15 x 2 cm · 154 gr

6 units · 0,93 kg

72 units · 13 kg

14930904

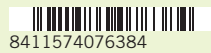

8411574076384

rendelési kód: G19175145



8 CSERÉLHETŐ VÁGÓFEJ
INTERCHANGEABLE BLADES
LAMES INTERCHANGEABLES

31,2 x 21,4 x 2cm · 0,27 kg

8 units · 2,34 kg

48 units · 15,01 kg

14930908



8411574006725



GYEREK OLLÓK · SCISSORS FOR KIDS
CISEAUX POUR ENFANTS

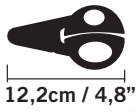

CSAK
PAPÍRHOZ
FOR PAPER ONLY
NE COUPENT
QUE LE
PAPIER



MŰANYAG VÁGÓÉL
PLASTIC BLADE
LAME EN PLASTIQUE



PATENTED DESIGN

12,2/4,8" x 6,7 x 1 cm · 29,9 gr

ISKOLAI OLLÓK · SCHOOL SCISSORS ·
CISEAUX SCOLAIRES



PATENTED DESIGN

12,3/4,8" x 6,6 x 1 cm · 29,9 gr

THE
FUN
SERIES



16

u./cajita
u./box
u./boîte

rendelési kód: G19182122

17,5 x 12,6 x 11,6 cm · 0,60 kg

8 units · 5,30 kg

14690716



8411574032328

rendelési kód: G19174BL1

15,5 x 9,5 x 1 cm · 40 gr

12 units · 0,49 kg

240 units · 10,40 kg

BWM10256



8411574038184



VÉDŐTOKOS OLLÓK · SCISSORS WITH PROTECTIVE CASE CISEAUX AVEC ÉTUI PROTECTEUR



case 14,7/5,8" x 5,3 x 1,1 cm · 26,5 gr



ladybird PATENTED DESIGN 14,7/5,7" x 5,3 x 1,1 cm · 25,4 gr

rendelési kód: G19172D24



24

u./cajita
u./box
u./boîte

19,5 x 15 x 11,5 cm · 0,78 kg

12 units · 10,30 kg

1409824



8411574021179

rendelési kód: G19178150



20

u./cajita
u./box
u./boîte

19,7 x 15 x 12 cm · 0,88 kg

8 units · 7,60 kg

1469820



8411574026310

rendelési kód: G19172145



10

unidades/cajita
units/box
unités/boîte

14,5 x 5,3 x 1,1 cm · 26 gr

10 units · 0,29 kg

500 units · 14,80 kg

140201



8411574000372



rendelési kód: MIL000593

17,5 x 9,5 x 1 cm · 36 gr

12 units · 0,47 kg

240 units · 10 kg

BWM10255



8411574038177



rendelési kód: MIL000586

19 x 9,5 x 1 cm · 45 gr

12 units · 0,60 kg

240 units · 12,40 kg

BWM10017



8411574026488



MŰANYAG VÉDŐTOKKAL
WITH PROTECTIVE CASE
AVEC ÉTUI PROTECTEUR

RUGÓS NYELŰ OLLÓK
SPRING-LOADED SCISSORS · CISEAUX AVEC
RESSORT RÉGULATEUR DE PRESSION



14,4cm / 5,7"

return

PATENTED DESIGN

14/5,5" x 5,7 x 1 cm · 28 gr

BALKEZES OLLÓK
SCISSORS FOR LEFT-HANDED PEOPLE
CISEAUX POUR GAUCHERS



14cm / 5,5"

Left

14/5,5" x 5,7 x 1 cm · 25,4 gr

rendelési kód: G19173145



18

u./cajita
u./box
u./boîte

19,5 x 14,5 x 11,5 cm · 0,63 kg

8 units · 5,60 kg

1489818

8411574026303

rendelési kód: G19177145

**TOP
SELLER**

20

u./cajita
u./box
u./boîte

15 x 14,5 x 11,5 cm · 0,64 kg

12 units · 8,20 kg

1439620

8411574035084



rendelési kód: MIL000589



18 x 9,5 x 1,5 cm · 37 gr

12 units · 0,48 kg

240 units · 10,10 kg

BWM10019

8411574026501

KÖNNYED VÁGÁS
TO CUT WITHOUT EFFORT
POUR COUPER SANS EFFORT

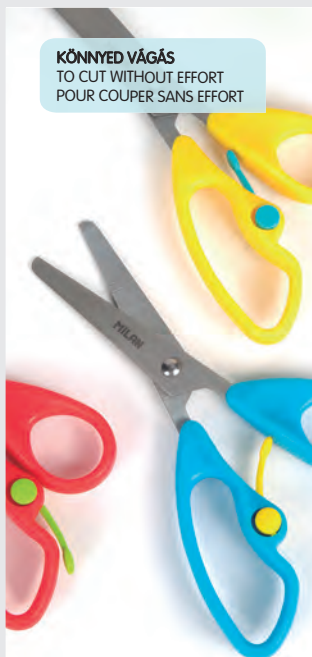

rendelési kód: G19177BL1



19,3 x 8 x 1 cm · 33 gr

12 units · 0,43 kg

240 units · 9,50 kg

BWM10259

8411574038276

BALKEZESEKNEK
FOR LEFT-HANDED PEOPLE
POUR GAUCHERS



ERGONOMIKUS OLLÓK · ERGONOMIC SCISSORS · CISEAUX ERGONOMIQUES

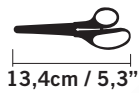

basic 13,4/5,3" x 5,3 x 1,1 cm · 19,5 gr

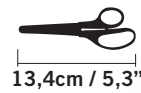

basic colours 13,4/5,3" x 5,3 x 1,1 cm · 19,5 gr

rendelési kód: G19171115



24

u./cajita
u./box
u./boîte

16,5 x 14 x 11,5 cm · 0,59 kg

12 units · 7,70 kg

80066



8411574800668



rendelési kód: MIL000591

19,3 x 8 x 1 cm · 28 gr

12 units · 0,38 kg

240 units · 8,10 kg

BWM10039



8411574027492

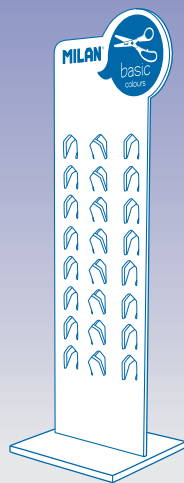

EXPOSITORES
DISPLAYS
PRÉSENTOIRS PG 268 >



10

unidades/cajita
units/box
unités/boîte

13,5 x 5,5 x 7 cm · 0,22 kg

40 units · 9,20 kg

● 1412081051



rendelési kód: G19183100

● 1412081029



rendelési kód: G19183400

● 1412081080



rendelési kód: G19183200

● 1412081020



rendelési kód: G19183550



rendelési kód: MIL000608

18 x 9,5 x 1 cm · 28 gr

12 units · 0,38 kg

240 units · 8,10 kg

BWM10341



8411574057888

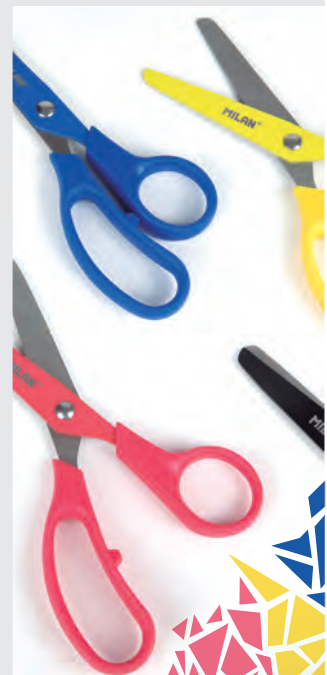

ERGONOMIKUS OLLÓK · ERGONOMIC SCISSORS · CISEAUX ERGONOMIQUES

13,4cm / 5,3"



basic
SUNSET SERIES 13,4/5,3" x 5,3 x 1,1 cm · 19,5 gr

13,4cm / 5,3"



basic
PASTEL SERIES 13,4/5,3" x 5,3 x 1,1 cm · 19,5 gr

| | |
|--|--|
| <p>rendelési kód: G19187550</p> <p>18 x 9,5 x 1 cm · 28 gr</p> <p>12 units · 0,38 kg</p> <p>240 units · 8,10 kg</p> <p>BWM10444Y</p> <p>8411574091202</p> | <p>rendelési kód: G19187150</p> <p>18 x 9,5 x 1 cm · 28 gr</p> <p>12 units · 0,38 kg</p> <p>240 units · 8,10 kg</p> <p>BWM10444T</p> <p>8411574091219</p> |
|--|--|

| | |
|---|---|
| <p>rendelési kód: G19185550</p> <p>18 x 9,5 x 1 cm · 28 gr</p> <p>12 units · 0,38 kg</p> <p>240 units · 8,10 kg</p> <p>BWM10426VN</p> <p>8411574085195</p> | <p>rendelési kód: G19185700</p> <p>18 x 9,5 x 1 cm · 28 gr</p> <p>12 units · 0,38 kg</p> <p>240 units · 8,10 kg</p> <p>BWM10426LV</p> <p>8411574085171</p> |
|---|---|



NEW!

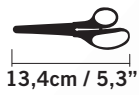

basic 13,4/5,3" x 5,3 x 1,1 cm · 19,5 gr



rendelési kód: G19188200

18 x 9,5 x 1 cm · 28 gr

12 units · 0,38 kg

240 units · 8,10 kg

BWM10341DW



8411574106364



PROFESSZIONÁLIS OLLÓK · PROFESSIONAL SCISSORS · CISEAUX PROFESSIONNELS

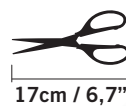
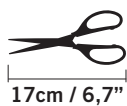

TITÁN BEVONAT
TITANIUM COATING
REVÊTEMENT EN TITANE



COPPER
SERIES



TOP
SELLER

acid
SERIES



PATENTED DESIGN 17/6,7" x 5,9 x 1,2 cm · 29 gr

PATENTED DESIGN 17/6,7" x 5,9 x 1,2 cm · 29 gr

rendelési kód: G19184200

rendelési kód: G19184300

rendelési kód: G19186550

rendelési kód: G19186650

rendelési kód: G19186100

| | | | | |
|-----------------------------|-----------------------------|-----------------------------|-----------------------------|-----------------------------|
| 23,1 x 6,9 x 1,3 cm · 38 gr | 23,1 x 6,9 x 1,3 cm · 38 gr | 23,1 x 6,9 x 1,3 cm · 38 gr | 23,1 x 6,9 x 1,3 cm · 38 gr | 23,1 x 6,9 x 1,3 cm · 38 gr |
| 12 units · 0,53 kg | 12 units · 0,53 kg | 12 units · 0,53 kg | 12 units · 0,53 kg | 12 units · 0,53 kg |
| 240 units · 11,13 kg | 240 units · 11,13 kg | 240 units · 11,13 kg | 240 units · 11,13 kg | 240 units · 11,13 kg |
| BWM10425CPK | BWM10425CPGR | BWM10425Y | BWM10425P | BWM10425B |
| | | | | |
| 8411574097433 | 8411574097419 | 8411574085164 | 8411574085157 | 8411574085140 |

IRODAI OLLÓK · OFFICE SCISSORS · CISEAUX DE BUREAU



PATENTED DESIGN

rendelési kód: G19179200

MILAN

TUERAS
SCISSORS
CISEAUX
SHCERE

HOJA DE METAL
RESISTENTE
RESISTANT METAL
BLADE

SOFT

MILAN since 1918, SPAIN

20,5 cm / 8"

PATENTED DESIGN

26,5 x 10,5 x 1,3 cm · 82 gr

12 units · 1,10 kg

144 units · 13,80 kg

BWM10150

8411574032366

20,2cm / 7,9"

PATENTED DESIGN

rendelési kód: G19179205

MILAN

TUERAS
SCISSORS
CISEAUX
SHCERE

HOJA DE METAL
RESISTENTE
RESISTANT METAL
BLADE

SOFT

MILAN since 1918, SPAIN

20,5 cm / 8"

PATENTED DESIGN

26,5 x 10,5 x 1,3 cm · 82 gr

12 units · 1,10 kg

144 units · 13,80 kg

BWM10150DB

8411574036302

20,2cm / 7,9"

PATENTED DESIGN

rendelési kód: G19176400

MILAN

TUERAS
SCISSORS
CISEAUX
SHCERE

HOJA DE METAL
RESISTENTE
RESISTANT METAL
BLADE

SOFT

MILAN since 1918, SPAIN

20 cm / 7,8"

PATENTED DESIGN

26,5 x 11 x 1,1 cm · 84 gr

12 units · 1,10 kg

144 units · 13,80 kg

BWM10151

8411574032373

19,8cm / 7,8"

IRODAI OLLÓK · OFFICE SCISSORS · CISEAUX DE BUREAU



PATENTED DESIGN

rendelési kód: G19180400

MILAN®

TIJERAS
SCISSORS
CISEAUX
SZICERE

HOJA DE METAL
RESISTENTE
RESISTANT METAL
BLADE

MILAN since 1918, SPAIN

SOFT

19 cm / 7,5"

PATENTED DESIGN

26,3 x 11 x 1,3 cm · 82 gr

12 units · 1,05 kg

144 units · 13,40 kg

BWM10264

8411574040200

19 cm / 7,5"

PATENTED DESIGN

rendelési kód: G19181500

MILAN®

TIJERAS
SCISSORS
CISEAUX
SZICERE

HOJA DE METAL
RESISTENTE
RESISTANT METAL
BLADE

MILAN since 1918, SPAIN

SOFT

22 cm / 8,7"

PATENTED DESIGN

26,5 x 11 x 1,3 cm · 94 gr

12 units · 1,22 kg

144 units · 15,40 kg

BWM10265

8411574040231

22,2cm / 8,7"

KERÁMIA TAPÉTVÁGÓK CSERÉLHETŐ PENGÉVEL
CUTTERS WITH SHARP CERAMIC BLADE. REPLACEABLE
CUTTERS AVEC LAME CÉRAMIQUE AIGUISÉE. REMPLAÇABLE



CAPSULE ceramic CUTTER **ZACID** PATENTED DESIGN 10,8 x 4,5 x 1,7 cm · 21,8 gr

8
u. cajita
u. box
u. boîte

rendelési kód: MIL000340

rendelési kód: MIL000490

16 x 10 x 1,8 cm · 33 gr

24 units · 0,89 kg

192 units · 7,80 kg

BWM10337B

8411574099291

18 x 16 x 11 cm · 0,38 kg

3 units · 1,22 kg

24 units · 10,59 kg

6005108B

8411574100621

8
u. cajita
u. box
u. boîte

rendelési kód: MIL000341

rendelési kód: MIL000510

16 x 10 x 1,8 cm · 33 gr

24 units · 0,89 kg

192 units · 7,80 kg

BWM10337Y

8411574099284

18 x 16 x 11 cm · 0,38 kg

3 units · 1,22 kg

24 units · 10,59 kg

6005108Y

8411574100638

NÉZD MEG A VIDEÓT

CSERÉLHETŐ PÓTÉL · REPLACEMENT BLADE · LAME DE RECHANGE

rendelési kód: MIL000170

13,5 x 8 x 1 cm · 12 gr

12 units · 0,18 kg

96 units · 1,60 kg

BWM10338

8411574056522

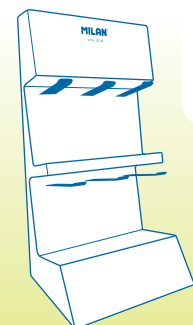

EXPOSITORES
DISPLAYS
PRÉSENTOIRS
PG 268 >

KERÁMIA TAPÉTVÁGÓK CSERÉLHETŐ PENGÉVEL
 CUTTERS WITH SHARP CERAMIC BLADE. REPLACEABLE
 CUTTERS AVEC LAME CÉRAMIQUE AIGUISÉE. REMPLAÇABLE

BIZTONSÁGI ZÁRRAL WITH SAFE LOCK SYSTEM

1918 SERIES

2 PENGÉ POZÍCIÓ CUTTING POSITIONS

STICK ceramic CUTTER PATENTED DESIGN 11,1 x 2,9 x 1,7 cm · 15,9 gr

8 u. cajita u. box u. boîte

rendelési kód: MIL000342

rendelési kód: MIL000629

16 x 10 x 1,6 cm · 25 gr

24 units · 0.73 kg

192 units · 6.50 kg

BWM10348B

8411574101109

18 x 16 x 11 cm · 0,30 kg

3 units · 1.09 kg

24 units · 9.69 kg

6010108B

8411574101123

8 u. cajita u. box u. boîte

rendelési kód: MIL000343

rendelési kód: MIL000633

16 x 10 x 1,6 cm · 25 gr

24 units · 0.73 kg

192 units · 6.50 kg

BWM10348P

8411574101093

18 x 16 x 11 cm · 0,30 kg

3 units · 1.09 kg

24 units · 9.69 kg

6010108P

8411574101116

NÉZ MEG A VIDEÓT

CSERÉLHETŐ PÓTÉL · REPLACEMENT BLADE · LAME DE RECHANGE



rendelési kód: MIL000662

13,5 x 8 x 1 cm · 9 gr

12 units · 0,15 kg

96 units · 1,40 kg

BWM10352B

8411574101154

rendelési kód: MIL000647

CSERÉLHETŐ PÓTÉL
 REPLACEMENT BLADE
 LAME DE RECHANGE

13,5 x 8 x 1 cm · 9 gr

12 units · 0,15 kg

96 units · 1,40 kg

BWM10352

8411574062813

FOLYÉKONY RAGASZTÓ · WHITE GLUE · COLLE BLANCHE

rendelési kód: MIL000182



100g

13,5 x 5,8 x 2,7 cm · 121 gr



12 unidades/cajita
units/box
unités/boîte

17 x 14 x 12 cm · 1,40 kg

6 units · 9,50 kg

4432912



8411574079897

250g



18 x 8,5 x 3,4 cm · 0,28 kg

ÁTLÁTSZÓRA SZÁRAD
TRANSPARENT WHEN DRY
TRANSPARENTE AU SÉCHAGE

OLDÓSZERMENTES
SOLVENT FREE
SANS DISSOLVANTS

MOSHATÓ
WASHABLE
LAVABLE

rendelési kód: MIL000344



6 unidades/cajita
units/box
unités/boîte

18 x 17,5 x 10,5 cm · 1,70 kg

6 units · 10,80 kg

4435906



8411574095194

FOLYÉKONY RAGASZTÓ · CLEAR GLUE · COLLE TRANSPARENTE

rendelési kód: MIL000041



118g

13,4 x 6,2 x 3,1 cm · 138,4 gr



12 unidades/cajita
units/box
unités/boîte

19 x 12,5 x 13,5 cm · 1,71 kg

6 units · 10,81 kg

4442912



8411574103066

OLDÓSZERMENTES
SOLVENT FREE
SANS DISSOLVANTS

MOSHATÓ
WASHABLE
LAVABLE

RAGASZTÓROLLER · GLUE TAPE · COLLE EN RUBAN

rendelési kód: G14175084



CSÚSZTATHATÓ SLIDE

8,4 mm x 5 m

7,5 x 3,5 x 2 cm · 18,2 gr

VÉDŐKUPAKKAL
PROTECTIVE TAB
LANGUETTE DE PROTECTION

24 u. cajita u. box u. boîte

14,5 x 14 x 8 cm · 0,45 kg
12 units · 6,20 kg

4401924



5 MÉTER/METERS/MÈTRES



8411574070337

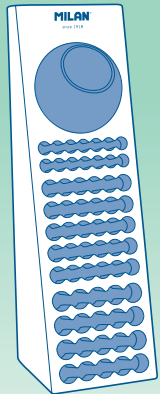

EXPOSITORES
DISPLAYS
PRÉSENTOIRS PG 266 >

rendelési kód: G14174084



VÉDŐKUPAKKAL WITH CAP AVEC CAPUCHON

8,4 mm x 12 m

9,8 x 4 x 1,8 cm · 36 gr

12 MÉTER/METERS/MÈTRES



acid SERIES

12 unidades/cajita units/box unités/boîte

16,5 x 15,5 x 14 cm · 0,50 kg
12 units · 7,00 kg

44GT12



8411574000075

rendelési kód: G13189000



NEW LOOK SERIES

8,4 mm x 8 m

10,8 x 3,5 x 1,7 cm · 25,5 gr

VISSZAZÁRHTÓ
RETRACTABLE PUSHER
POUSSOIR RÉTRACTABLE

12 u. cajita u. box u. boîte

17,5 x 12,5 x 1,2 cm · 0,58 kg
12 units · 7 kg

4402912LK2



8411574097020

RAGASZTÓROLLER BETÉT
GLUE TAPE REFILL
RECHARGE DE ROLLER DE COLLE



rendelési kód: MIL000774

17,3 x 10 x 1 cm · 32 gr
36 units · 1,40 kg

BWM10492



8411574101451

RAGASZTÓSTIFT · GLUE STICK · COLLE EN BÂTON



GYORSAN SZÁRAD
QUICK DRY
SÉCHAGE RAPIDE

OLDÓSZERMENTES
SOLVENT FREE
SANS DISSOLVANTS

MOSHATÓ
WASHABLE
LAVABLE

**TOP
SELLER**



8g

8,3 x Ø 2 cm · 17,5 gr

**TOP
SELLER**



21g

10,6 x Ø 2,6 cm · 38,7 gr

**TOP
SELLER**



40g

12 x Ø 3 cm · 62,7 gr

rendelési kód: G14170008

24

u. cajita
u. box
u. böite



8g

12,1 x 8,6 x 8,3 cm · 0,47 kg

16 units · 8,10 kg

4410924



8411574075158



17 x 8,2 x 3,6 cm · 97 gr

12 units · 1,32 kg

BWM10408



rendelési kód: MIL000692



8,4 x 8,1 x 2 cm · 74 gr

12 units · 1 kg

96 units · 8,80 kg

4410404MLN



rendelési kód: MIL000251

rendelési kód: G14170021

12

u. cajita
u. box
u. böite



21g

10,1 x 7,8 x 11 cm · 0,50 kg

24 units · 12,80 kg

4415912



8411574072447



rendelési kód: MIL000715

17 x 8,2 x 2,7 cm · 85,5 gr

12 units · 1,17 kg

BWM10436



8411574088691

rendelési kód: G14170040

12

u. cajita
u. box
u. böite



40g

9,2 x 12,1 x 12,4 cm · 0,81 kg

12 units · 10,30 kg

4420912



8411574075165



RAGSZTÓSTIFT · GLUE STICK · COLLE EN BÂTON



8,3 x Ø 2 cm · 17,5 gr

8 g

NEW!



10,6 x Ø 2,6 cm · 38,7 gr

21 g

ÁTLÁTSZÓRA SZÁRAD
INVISIBLE COLOUR WHEN DRY
COULEUR INVISIBLE AU SÉCHAGE



10,6 x Ø 2,6 cm · 38,7 gr

21 g

rendelési kód: G14180008

24

u. cajtita
u. box
u. boíte



12,1 x 8,6 x 8,3 cm · 0,47 kg

16 units · 8,10 kg

4410924SN



8411574089032



rendelési kód: MIL000737

17 x 8,2 x 2,8 cm · 45 gr

12 units · 0,64 kg

BWM10449

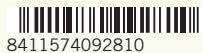

8411574092810



12

u. cajtita
u. box
u. boíte



TOP
SELLER

rendelési kód: G14170B21

10,1 x 7,8 x 11 cm · 0,50 kg

24 units · 12,80 kg

4415912TN



8411574106302



12

u. cajtita
u. box
u. boíte



TOP
SELLER

rendelési kód: G14170P21

10,1 x 7,8 x 11 cm · 0,50 kg

24 units · 12,80 kg

4415912FR



8411574100799



NÉZD MEG
A VIDEÓT

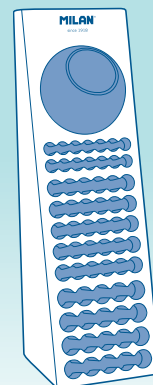

EXPOSITORES
DISPLAYS
PRÉSENTOIRS
PG 266 >

FOLYÉKONY HIBAJAVÍTÓK · LIQUID CORRECTORS · CORRECTEURS LIQUIDES



15 x Ø 1,59cm · 18,5 gr

7 ml

A folyadék a tolltest nyomásával adagolható.
By pressing on the body the flow of liquid increases.
Le débit de liquide augmente lorsque l'on appuie sur le corps du correcteur.

| | | | |
|--|---|---|--|
| <p>rendelési kód: MIL000784</p> <p>21 x 6,5 x 2,3 cm · 27 gr</p> <p>24 units · 0,85 kg</p> <p>BWM80102BL</p> <p>8411574010128</p> | <p>rendelési kód: G13172000</p> <p>12 u. cajita u. box u. boîte</p> <p>15,3 x 8 x 4,5 cm · 0,24 kg</p> <p>36 units · 9,40 kg</p> <p>80103</p> <p>8411574801030</p> | <p>rendelési kód: MIL000034</p> <p>20 x 17,5 x 7 cm · 0,62 kg</p> <p>9 units · 6,30 kg</p> <p>1307924</p> <p>8411574005650</p> | <p>rendelési kód: MIL000034</p> <p>24 unidades/cajita units/box unités/boîte</p> |
|--|---|---|--|

NEW DESIGN!



TOP SELLER

10,3 x Ø 1,46cm · 16,9 gr

5 ml

mini
CORRECTOR

A folyadék a tolltest nyomásával adagolható.
By pressing on the body the flow of liquid increases.
Le débit de liquide augmente lorsque l'on appuie sur le corps du correcteur.

| | |
|---|--|
| <p>rendelési kód: G13175005</p> <p>NEW DESIGN!</p> <p>12 unidades/cajita units/box unités/boîte</p> <p>10,6 x 8,6 x 5,3 cm · 0,23 kg</p> <p>48 units · 11,50 kg</p> <p>1305212</p> <p>8411574044864</p> | |
|---|--|

HIBAJAVÍTÓ ROLLER · DRY CORRECTION TAPE
RUBAN CORRECTEUR À SEC



8 MÉTER/METERS/MÈTRES

5 mm x 8 m

180°

MILAN BC185

Correction tape 5mm x 8m

ELFORGATHATÓ FEJ
SWIVEL HEAD
TÊTE ROTATIVE

180°

KÉTKEZES HASZNÁLAT
AMBIDEXTROUS USE
USAGE AMBIDEXTRE

L & R

9 x 4,4 X 1,5 cm · 25,5 gr

rendelési kód: G13188000



13,5 x 15 x 9,5 cm · 0,80 kg

8 units · 6,80 kg

1385936

8411574095064

NEW DESIGN!



rendelési kód: G13182000

15,5 x 14,5 x 11 cm · 0,37 kg

20 units · 8,70 kg

80185

8411574121853

12 u. cajita u. box u. boîte



rendelési kód: MIL000480

14,1 x 8,1 x 1,8 cm · 25 gr

12 units · 0,36 kg

BC185

8414034901851



15 MÉTER/METERS/MÈTRES

5 mm x 15 m EXTRA-HOSSZÚ

180°

MILAN

Correction tape 5mmx15m

15 METERS

ELFORGATHATÓ FEJ
SWIVEL HEAD
TÊTE ROTATIVE

180°

KÉTKEZES HASZNÁLAT
AMBIDEXTROUS USE
USAGE AMBIDEXTRE

L & R

9 x 4,4 X 1,5 cm · 25,5 gr

rendelési kód: G13190000



15,5 x 14,5 x 11 cm · 0,37 kg

20 units · 8,70 kg

1315912LK2

8411574097006

12 u. cajita u. box u. boîte



VEGYES SZÍNEK

rendelési kód: MIL000755

14,1 x 8,1 x 1,8 cm · 26 gr

12 units · 0,37 kg

BWM10476

8411574096993

NEW LOOK SERIES

HIBAJAVÍTÓ ROLLER · DRY CORRECTION TAPE
RUBAN CORRECTEUR À SEC

NEW!

6 MÉTER/METERS/MÈTRES



5 mm
x 6 m

7,7 x Ø2,2 cm · 12,3 gr

KÉTKÉZES HASZNÁLAT
AMBIDEXTROUS USE
USAGE AMBIDEXTRE



ELFORGATHATÓ FEJ
SWIVEL HEAD
TÊTE ROTATIVE

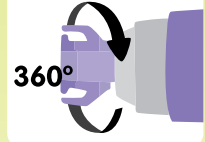

40

u. cajita
u. box
u. boîte



12,5 x 12,5 x 12,5 cm · 0,61 kg

12 units · 7,80 kg

1301940SN



8411574106203

rendelési kód: G13191000



VEGYES SZÍNEK

14 x 8,2 x 2,5 cm · 19 gr

12 units · 0,30 kg

BWM10340SN



8411574106531

rendelési kód: MIL000606

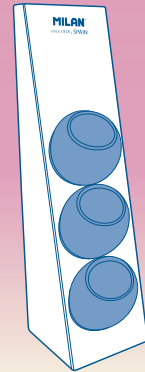

EXPOSITORES
DISPLAYS
PRÉSENTOIRS PG 266 >



HIBAJAVÍTÓ ROLLER · DRY CORRECTION TAPE RUBAN CORRECTEUR À SEC

6 METER/METERS/MÈTRES

5 mm x 6 m

7,7 x Ø2,2 cm - 12,3 gr

L & R

KÉTKÉZES HASZNÁLAT
AMBIDEXTROUS USE
USAGE AMBIDEXTRE

ELFORGATHATÓ FEJ
SWIVEL HEAD
TÊTE ROTATIVE

360°

rendelési kód: G13183000

40 unidades/cajita
units/box
unités/boîte

rendelési kód: G13183D40

1918
SERIES

40
u. cajita
u. box
u. boîte

18 x 11,5 x 8 cm · 0,53 kg

12 units · 7,00 kg

1301240



8411574072270

12,5 x 12,5 x 12,5 cm · 0,61 kg

12 units · 7,80 kg

1301940SNC



8411574095422

1918

SERIES

2 HIBAJAVÍTÓ ROLLER BETÉT
2 CORRECTION TAPE REFILLS
2 RECHARGES RUBAN CORRECTEUR

VEGYES SZÍNEK

rendelési kód: MIL000607

14 x 8,2 x 2,5 cm · 19 gr

12 units · 0,30 kg

BWM10340SNC



8411574096023

rendelési kód: MIL000579

17 x 7,5 x 2 cm · 21 gr

12 units · 0,30 kg

72 units · 2,25 kg

BWM10467



8411574095385

HIBAJAVÍTÓ ROLLER CSERE BETÉTTEL
CORRECTION TAPE WITH A REFILL
RUBAN CORRECTEUR AVEC UNE RECHARGE

rendelési kód: MIL000756

18 x 17,7 x 9,7 cm · 18 gr

12 units · 0,30 kg

72 units · 2 kg

BWM10478B



8411574097594

HIBAJAVÍTÓ ROLLER CSERE BETÉTTEL
CORRECTION TAPE WITH A REFILL
RUBAN CORRECTEUR AVEC UNE RECHARGE

rendelési kód: MIL000760

18 x 17,7 x 9,7 cm · 18 gr

12 units · 0,30 kg

72 units · 2 kg

BWM10478P



8411574097600

HIBAJAVÍTÓ ROLLER · DRY CORRECTION TAPE
RUBAN CORRECTEUR À SEC



5 MÉTER/METERS/MÈTRES

4,2 mm x 5 m

6,3 x 3 x 1,3 cm · 9 gr

acid
SERIES



VEGYES SZÍNEK

MILAN

rendelési kód: MIL000691

16 x 6,5 x 1,7 cm · 25 gr

12 units · 0,35 kg

BWM10406

8411574080022



12
u. cajtja
u. box
u. böite

rendelési kód: MIL000384

16 x 14 x 10 cm · 0,35 kg

12 units · 5 kg

1302912

8411574081302



5 mm x 6 m

6 MÉTER/METERS/MÈTRES

10,9 x 2,5 x 2 cm · 14,8 gr

VISSZAZÁRHTÓ
RETRACTABLE
PUSHER
POUSSOIR
RÉTRACTABLE

acid
SERIES



rendelési kód: MIL000337

13,5 x 8 x 1 cm · 17 gr

24 units · 0,65 kg

BWM10443

8411574091196

KÖNNYEDÉN CSERÉLHETŐ BETÉT
EASY TO INSTALL
REFILLS
RECHARGES
FACILES À INSTALLER



rendelési kód: MIL000751

15,3 x 5,2 x 2 cm · 19 gr

48 units · 1,80 kg

BWM10466B

8411574095378



rendelési kód: G13187000

12
u. cajtja
u. box
u. böite

14 x 11,6 x 4 cm · 0,20 kg

30 units · 7,30 kg

1304912

8411574089872

GÉMKAPCSOK · CLIPS · TROMBONES



METAL 28 mm

100 unidades/cajita
units/box
unités/boîte



PLASTIC METAL 33 mm

100 unidades/cajita
units/box
unités/boîte



METAL 43 mm

100 unidades/cajita
units/box
unités/boîte

rendelési kód: G07171028



6,3 x 4 x 2,5 cm · 44 gr

10 units · 0,47 kg

240 units · 11,90 kg

80080



8411574800804

rendelési kód: G07172033



7,5 x 4,5 x 2,4 cm · 52 gr

10 units · 0,56 kg

240 units · 14,10 kg

80084



8411574800842

rendelési kód: G07171043



8,5 x 5 x 2,5cm · 92 gr

10 units · 0,96 kg

100 units · 10,20 kg

80082



8411574800828



METAL 33 mm

100 unidades/cajita
units/box
unités/boîte

rendelési kód: G07171033



6,3 x 4 x 2,5cm · 50 gr

10 units · 0,52 kg

240 units · 13,00 kg

80081



8411574800811



rendelési kód: MIL000697

14 x 8,2 x 2,7 cm · 54,7 gr

12 units · 0,78 kg

BWM10430



8411574088042

TÉRKÉPTŰ
PUSH PINS
ÉPINGLES DE SIGNALISATION

rendelési kód: H09171000



30 unidades/cajita
units/box
unités/boîte

8,7 x 5,4 x 1,7 cm · 24 gr

10 units · 0,28 kg

240 units · 7,10 kg

80086



8411574800866

RAJZSZEG
PINS
PUNAISES

rendelési kód: G10171070



70 unidades/cajita
units/box
unités/boîte

5,2 x 3,2 x 2,2 cm · 20 gr

10 units · 0,23 kg

500 units · 12,30 kg

80091



8411574800910

ÖNTAPADÓ JEGYZETTÖMB ADAGOLÓVAL · ADHESIVE PAPER STRIP DISPENSER ROLL · ROULEAU DE RUBAN DE PAPIER ADHÉSIF

ÖNTAPADÓ JEGYZETTÖMB
50mm x 10 m

SUPER STICKY!

rendelési kód: MIL000057



18 unidades/cajita
units/box
unités/boîte

17,5 x 16,5 x 10,5 cm · 1,15 kg

8 units · 9,95 kg

415081018



8411574101673



NÉZD MEG
A VIDEÓT

ÖNTAPADÓ JEGYZETSZALAG
OLDALJELÖLÉSRE, RENDSZEREZÉSHEZ,
ELTÁVOLÍTHATÓ JELÖLÉSRE ÉS
RADÍRMORZSALÉK ELTÁVOLÍTÁSÁRA
STICKY PAPER STRIPS FOR PAGE MARKERS,
CATEGORISATION, STRIP MARKERS AND
SHAVING CLEANER
RUBAN DE PAPIER ADHÉSIF POUR MARQUE-
PAGES, CLASSEMENT, LIMITEUR DE BANDE
ET ÉLIMINATION DES COPEAUX



5,4 x 5,2 x 5 cm · 57 gr



Teljes hátoldalán ragasztott felület. Az adagolón található vágóélel a kívánt méretre vágható.

With full adhesive backing. In its packaging includes an edge for cutting to the desired size.

Adhésif sur toute la surface arrière. Inclut sur l'emballage une arête pour couper à la dimension souhaitée.



AJÁNLOTT:
MŰVÉSZEKNEK, használatával festésnél a képeknek határozott, egyenes szélét lehet adni. Segítségével a radírozás után visszamaradt radírmorzsalék összegyűjthető és könnyedén eltávolítható a szénrajzokról, grafikákról.

USEFUL FOR:
FINE ARTS, it allows to frame and limit the surface of the paintings. It allows to stick the shavings resulting from erasing and is especially useful to remove them from surfaces drawn with charcoal.

UTILIZABLE POUR:
BEAUX-ARTS, permet d'encadrer et limiter la surface des peintures. Permet de coller les résidus de gommage et spécialement utilisé pour les enlever des surfaces dessinées avec du fusain.

ÁLTALÁNOS FELHASZNÁLÁS a szalag kívánt méretre vágásával. GYEREKJÁTÉK különböző formák kivágásával öntapadó rajzok készítése.

DOMESTIC USE by cutting sticky notes to the desired size. CHILDREN'S GAMES by cutting and drawing different adhesive shapes.

USAGE QUOTIDIEN en coupant la note adhésive à la taille souhaitée. JEUX D'ENFANTS en coupant et dessinant différentes formes adhésives.

OLDALJELÖLŐK · PAGE MARKERS · MARQUE-PAGES

rendelési kód: A14171000



PAPÍR
PAPER
DE PAPIER

40 u. 40 u. 40 u. 40 u.

8 x 5 x 0,5 cm · 17 gr

10 units · 0,17 kg

240 units · 4,45 kg

87039



8411574870395

rendelési kód: A14172000



ÁTLÁTSZÓ
TRANSLUCENT
TRANSLUCIDES

20 u. 20 u. 20 u. 20 u. 20 u.

8 x 5,2 x 0,4 cm · 7 gr

10 units · 85 gr

240 units · 2,25 kg

87000



8411574870005



rendelési kód: A14173000

ÁTLÁTSZÓ
TRANSLUCENT
TRANSLUCIDES

15 u. 15 u. 15 u. 15 u.
15 u. 15 u. 15 u. 15 u.

16,5 x 5,9 x 0,2 cm · 8 gr

24 units · 0,22 kg

288 units · 2,87 kg

419608



8411574040316



rendelési kód: A14176000

ÁTLÁTSZÓ
TRANSLUCENT
TRANSLUCIDES

35 u. 35 u. 35 u. 35 u.

13,6 x 7 x 0,8 cm · 15,8 gr

24 units · 0,43 kg

288 units · 5,60 kg

4111604



8411574075936



rendelési kód: A14177560

ÁTLÁTSZÓ
TRANSLUCENT
TRANSLUCIDES

50 u.

11,9 x 7 x 0,8 cm · 9 gr

24 units · 0,26 kg

288 units · 3,38 kg

411061001



8411574075912



rendelési kód: A14177660

ÁTLÁTSZÓ
TRANSLUCENT
TRANSLUCIDES

50 u.

11,9 x 7 x 0,8 cm · 9 gr

24 units · 0,26 kg

288 units · 3,38 kg

411060801



8411574075929

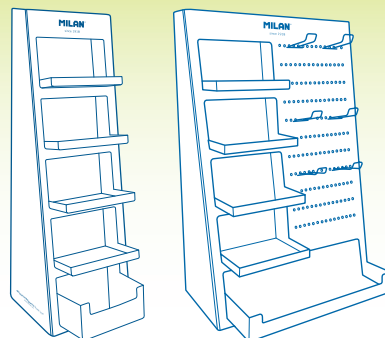

EXPOSITORES
DISPLAYS
PRÉSENTOIRS
PG 267 >

ÖNTAPADÓ JEGYZETTÖMBÖK · ADHESIVE NOTES · NOTES ADHÉSIVES

rendelési kód: A13174550



100 u.



7,6 x 7,6 x 1 cm · 42 gr

10 units · 0,42 kg

120 units · 5,26 kg

85401



8411574854012

rendelési kód: A13178550



90 u.

SZUPER ERŐS
SUPER STICKY
SUPER ADHÉSIVES

7,6 x 7,6 x 0,7 cm · 38 gr

10 units · 0,38 kg

120 units · 4,80 kg

417190



8411574060475

rendelési kód: A13181550



100 u.

VONALAZOTT
WITH LINES
AVEC LIGNES

7,6 x 7,6 x 0,9 cm · 42 gr

10 units · 0,42 kg

120 units · 5,26 kg

4151PTL100



8411574089988

rendelési kód: A13173555



100 u.

7,6 x 7,6 x 1 cm · 42 gr

10 units · 0,42 kg

120 units · 5,14 kg

85434



8411574854340



100 u.

85435



rendelési kód: A13173605



100 u.

85433



rendelési kód: A13173305



100 u.

85432



rendelési kód: A13173655

rendelési kód: A13182308



90 u.

SZUPER ERŐS
SUPER STICKY
SUPER ADHÉSIVES

7,6 x 7,6 x 0,7 cm · 41 gr

10 units · 0,41 kg

120 units · 4,8 kg

41711P790



8411574089926

PASTEL
SERIES



90 u.

41711P890



rendelési kód: A13182658



90 u.

41711P690



rendelési kód: A13182108

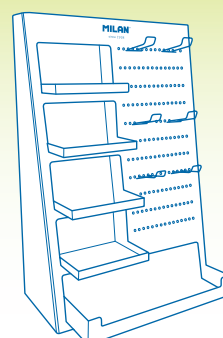
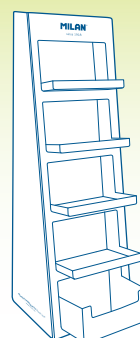

EXPOSITORES
DISPLAYS
PRÉSENTOIRS
PG 267 >

ÁTLÁTSZÓ ÖNTAPADÓ JEGYZETŐMBÖK · TRANSLUCENT ADHESIVE NOTES NOTES ADHÉSIVES TRANSLUCIDES

rendelési kód: A14175550

MILAN
50
Notas adhesivas de plástico translúcidas removibles.
Removable translucent plastic adhesive notes.
FLUO COLOURS
TRANSLUCIDAS TRANSLUCENT
50 u.
76x76 mm
Cod. 411261050

11,3 x 9,1 x 0,4 cm · 18 gr
18 units · 0,35 kg
216 units · 4,45 kg
411261050
8411574075943

rendelési kód: A14175650

MILAN
50
Notas adhesivas de plástico translúcidas removibles.
Removable translucent plastic adhesive notes.
FLUO COLOURS
TRANSLUCIDAS TRANSLUCENT
50 u.
76x76 mm
Cod. 411260850

11,3 x 9,1 x 0,4 cm · 18 gr
18 units · 0,35 kg
216 units · 4,45 kg
411260850
8411574075950

rendelési kód: A14175500

MILAN
50
NOTAS ADHESIVAS DE PLÁSTICO TRANSLUCIDAS REMOVIBLES.
REMOVABLE TRANSLUCENT PLASTIC ADHESIVE NOTES
FLUO COLOURS
TRANSLUCIDAS TRANSLUCENT
50 u.
76x76 mm
Cod. 411260050

11,3 x 9,1 x 0,4 cm · 18 gr
18 units · 0,35 kg
216 units · 4,45 kg
411260050
8411574102007



SZÍNES ÖNTAPADÓ JEGYZETŐMBÖK · COLOURED ADHESIVE NOTES NOTES ADHÉSIVES DE COULEUR

rendelési kód: A13177MIX

MILAN
NEON
76x76 mm
notas adhesivas removibles
removable sticky notes
Cod. 4155400

76x76 mm
50u. 50u. 50u. 50u. 50u. 50u. 50u.

7,6 x 7,6 x 3,9 cm · 0,17 kg
12 units · 2,04 kg
72 units · 12,57 kg
4155400
8411574060482

rendelési kód: A13177FLU

MILAN
FLUO COLOURS
76x76 mm
notas adhesivas sticky notes
notas adhesivas sticky notes
Cod. 415508400

76x76 mm
100u. 100u. 100u. 100u.

7,6 x 7,6 x 3,9 cm · 0,17 kg
12 units · 2,04 kg
72 units · 12,57 kg
415508400
8411574075967

rendelési kód: A13179FLU

MILAN
400
NOTAS ADHESIVAS STICKY NOTES
NOTES ADHÉSIVES COLLEZTES
FLUO COLOURS
76x76 mm
Cod. 4155NP400

76x76 mm
100u. 50u. 100u. 50u. 100u.

7,6 x 7,6 x 3,9 cm · 0,17 kg
12 units · 2,04 kg
72 units · 12,57 kg
4155NP400
8411574089902

rendelési kód: A13180FLU

MILAN
100
NOTAS ADHESIVAS STICKY NOTES
NOTES ADHÉSIVES COLLEZTES
FLUO COLOURS
76x76 mm
Cod. 4151NE100

76x76 mm
25u. 25u. 25u. 25u.

4 SZÍNES BLOKK
4 SEPARATE BLOCKS
4 BLOCS SÉPARÉS

7,6 x 7,6 x 0,9 cm · 42 gr
10 units · 0,42 kg
120 units · 5,26 kg
4151NE100
8411574089995

rendelési kód: A13176MIX

MILAN
NEON COLOURS
50x50 mm
notas adhesivas removibles
removable sticky notes
Cod. 411501

50x50 mm
50u. 50u. 50u. 50u. 50u.

TOP SELLER

5 x 5 x 2,5 cm · 46 gr
12 units · 0,58 kg
288 units · 14,37 kg
411501
8411574040293

rendelési kód: A13182PAS

MILAN
100
NOTAS ADHESIVAS STICKY NOTES
NOTES ADHÉSIVES COLLEZTES
FLUO COLOURS
76x76 mm
Cod. 4151PT100

76x76 mm
25u. 25u. 25u. 25u.

VÁLTOZATOS SZÍNEK
ALTERNATE COLOURS
COULEURS ALTERNÉES

7,6 x 7,6 x 0,9 cm · 40 gr
10 units · 0,42 kg
120 units · 5,26 kg
4151PT100
8411574097099

ÖNTAPADÓ JEGYZETÖMBÖK · ADHESIVE NOTES · NOTES ADHÉSIVES

rendelési kód: A13183108



41721P890
90 u.
rendelési kód: A13183658

41721P090
90 u.
rendelési kód: A13183558

41721P790
90 u.
rendelési kód: A13183308

41721P690
rendelési kód: A13183108

SZUPER ERŐS SUPER STICKY SUPER ADHÉSIVES
76x127 mm
90 u.

12,7 x 7,6 x 0,8 cm · 65 gr
10 units · 0,66 kg
120 units · 8 kg

8411574089940

rendelési kód: A13176550



4141250
rendelési kód: A13176550

75 x 100 mm
250 u.

notas adhesivas removibles
removable sticky notes

FACTIS, S.A. - Milano - Móroca - A.
J. 7058 MOHARAB, Zlomba (Szuart)
C.I.F. A17032790
MILAN since 1918

10 x 7,5 x 2,4 cm · 138 gr
36 units · 5,20 kg

8411574082835

rendelési kód: A13175550



85501
rendelési kód: A13175550

76 x 127 mm
100 u.

notas adhesivas removibles
removable sticky notes

12,7 x 7,6 x 1 cm · 71 gr
10 units · 0,71 kg
120 units · 8,67 kg

8411574855019



rendelési kód: A13172550



85601
rendelési kód: A13172550

50 x 76 mm
100 u.

notas adhesivas removibles
removable sticky notes

7,6 x 5 x 1 cm · 28 gr
10 units · 0,28 kg
240 units · 7,06 kg

8411574856016

rendelési kód: A13171550



85301
rendelési kód: A13171550

38 x 50 mm
3x100 u.

notas adhesivas removibles
removable sticky notes

12 x 5 x 1 cm · 42 gr
10 units · 0,42 kg
120 units · 5,32 kg

8411574853015

KAPOCSKISZEDŐ · STAPLE REMOVER · DÉGRAFEUR



acid
SERIES

BIZTONSÁGI ZÁR
SAFETY LOCK
BLOQUE DE SÉCURITÉ

5,7 x 4,2 x 3,5 cm · 18,7 gr

rendelési kód: MIL000180



13 x 8,9 x 3,4 cm · 26 gr

10 units · 0,33 kg

120 units · 4,40 kg

19007Y



8411574081210

rendelési kód: MIL000181



13 x 8,9 x 3,4 cm · 26 gr

10 units · 0,33 kg

120 units · 4,40 kg

19007B



8411574081227

TŰZŐGÉPEK ÉS BLISZTERES TŰZŐGÉPEK · STAPLERS AND STAPLES
AGRAFEUSES · AGRAFEUSES ET AGRAFES CONDITIONNÉES EN BLISTER



acid
SERIES

PATENTED DESIGN

9 x 7,3 x 3,3 cm · 149 gr

BÉÉPÍTETT KAPOCSKISZEDŐ
INCLUDES A
STAPLE REMOVER
AVEC
DÉGRAFEUSE

KÖNNYÍTETT TŰZÉS AZ ENERGIATAKARÉKOS KIALAKÍTÁSNAK KÖSZÖNHETŐEN
SMOOTH STAPLING WITH FORCE REDUCTION SYSTEM
AGRAFAGE DOUX AVEC SYSTÈME DÉMULTIPLICATEUR DE FORCE



NÉZD MEG A VIDEÓT

24/6
26/6

20 SHEETS

STAPLING

AJÁNDÉK 1000 TŰZŐKAPOCCSAL
INCLUDES BOX 1000 STAPLES
COMPREND BOÎTE 1000 AGRAFES

rendelési kód: G01178650



14,5 x 13,5 x 4,5 cm · 0,21 kg

9 units · 2 kg

36 units · 8,65 kg

191071P



8411574080435

rendelési kód: G01178550



14,5 x 13,5 x 4,5 cm · 0,21 kg

9 units · 2 kg

36 units · 8,65 kg

191071Y



8411574076179

rendelési kód: G01178100



14,5 x 13,5 x 4,5 cm · 0,21 kg

9 units · 2 kg

36 units · 8,65 kg

191071B



8411574076162

TŰZŐGÉPEK · STAPLERS · AGRAFEUSES

TŰZŐKAPOCCSAL FELTÖLTVE
INCLUDES ONE REFILL OF STAPLES
INCLUT UNE RECHARGE D'AGRAFES

rendelési kód: G01174200



13,5 x 5,5 x 3,5 cm · 122 gr



13,5 x 5,5 x 3,5 cm · 0,12 kg

10 units · 1,33 kg

70 units · 9,80 kg

80192



8411574801924

TŰZŐKAPOCCSAL FELTÖLTVE
INCLUDES ONE REFILL OF STAPLES
INCLUT UNE RECHARGE D'AGRAFES

rendelési kód: G01177200



14,5 x 6,5 x 4,5 cm · 0,22 kg



14,5 x 6,5 x 4,5 cm · 0,23 kg

10 units · 2,42 kg

40 units · 10,10 kg

80194



8411574801948

TŰZŐKAPOCS · STAPLES · AGRAFES

rendelési kód: G02171024



1000 unidades/cajita
units/box
unités/boîte



7 x 3,5 x 1,5 cm · 48 gr

10 units · 0,49 kg

200 units · 10 kg

80199



8411574801993



rendelési kód: MIL000752

14 x 8,2 x 3,2 cm · 99 gr

12 units · 1,33 kg

BWM10470



8411574095989

BLISZETERES TŰZŐGÉP AJÁNDÉK TŰZŐKAPOCCSAL · STAPLER WITH A BLISTER PACK OF STAPLES · AGRAFEUSE AVEC SES AGRAFES CONDITIONNÉES EN BLISTER

KÖNNYED TŰZÉS AZ ENERGIATAKARÉKOS KIALAKÍTÁSNAK KÖSZÖNHETŐEN
SMOOTH STAPLING WITH FORCE REDUCTION SYSTEM
AGRAFEAGE DOUX AVEC SYSTÈME DÉMULTIPLIFICATEUR DE FORCE

TŰZŐKAPOCCSAL FELTÖLTVE
INCLUDES ONE REFFIL OF 50 STAPLES
INCLUT UNE RECHARGE DE 50 AGRAFES



1918
SERIES

PATENTED DESIGN 13 x 8,1 x 3,3 cm · 0,25 kg



rendelési kód: G01176100

18 x 13,5 x 4,5 cm · 0,28 kg
12 units · 3,57 kg
36 units · 11,30 kg

171027B
8411574037125



LYUKASZTÓ · PUNCH · PERFORATEUR



17,5 x 6,5 x 5 cm · 0,19 kg



rendelési kód: G04174200



10,5 x 8,5 x 4 cm · 0,21 kg
10 units · 2,23 kg
50 units · 11,70 kg

19012K
8411574055334

LYUKASZTÓ · PUNCH · PERFORATEUR



acid
SERIES

BIZTONSÁGI ZÁR
SAFETY LOCK
BLOCCAGE DE SÉCURITÉ

PATENTED DESIGN 12 x 8 x 7,5 cm · 0,18 kg

18 SHEETS



PATENTED DESIGN 12 x 8 x 7,5 cm · 0,18 kg

18 SHEETS



rendelési kód: MIL000179

13,5 x 11 x 5,4 cm · 0,21 kg

6 units · 1,40 kg

24 units · 6 kg

19022B

8411574081784



rendelési kód: MIL000178

13,5 x 11 x 5,4 cm · 0,21 kg

6 units · 1,40 kg

24 units · 6 kg

19022Y

8411574081692

RAGASZTÓSZALAG + TÉPŐ · TAPE DISPENSER · DÉVIDOIRS



acid
SERIES

Ø 75 mm

KÉTFÉLE ADAPTER
DOUBLE ADAPTER
ADAPTATEUR DOUBLE

Ø 25 mm

21 x 10,2 x 8,7 cm · 1,34 kg



acid
SERIES

Ø 75 mm

KÉTFÉLE ADAPTER
DOUBLE ADAPTER
ADAPTATEUR DOUBLE

Ø 25 mm

21 x 10,2 x 8,7 cm · 1,34 kg

rendelési kód: G15174200



21,5 x 10,8 x 9 cm · 1,34 kg

10 units · 14,80 kg

80210

8411574802105

rendelési kód: G15174850



21,5 x 10,8 x 9 cm · 1,34 kg

10 units · 14,80 kg

80209

8411574802099

RAGASZTÓSZALAG · ADHESIVE TAPE · RUBAN ADHÉSIF

| | | | |
|--|--|--|---|
| rendelési kód: G14-172012  | rendelési kód: G14-171066  | rendelési kód: MIL000588  | rendelési kód: MIL000587  |
| | | | |
| ø10,5 x 1,3 cm · 43 gr 12 units · 0,52 kg 288 units · 13,16 kg | ø10,5 x 2 cm · 68 gr 8 units · 0,55 kg 192 units · 13,30 kg | ø10,3 x 1,2 cm · 43 gr 12 units · 0,52 kg 192 units · 8,8 kg | ø10,3 x 1,9 cm · 67,5 gr 8 units · 0,54 kg 120 units · 8,5 kg |
| 80203  8411574802037 | 80204  8411574802044 | 34320  8411574100980 | 34340  8411574100997 |

FÉNYES RAGASZTÓSZALAG · GLOSS ADHESIVE TAPE · RUBAN ADHÉSIF BRILLANT

| | | | | | |
|---|---|--|---|---|--|
|  | 12 mm x 33 m rendelési kód: G14171012  | ADAGOLÓVAL WITH DISPENSER AVEC DÉVIDOIR  |  | 36 unidades/cajita units/box unités/boîte  | rendelési kód: G15169012  |
| | | | | | |
| 80201  8411574802013 | BW10432  8411574088363 | BW10479  8411574097662 | 3411D836  8411574095316 | | |

FÉNYES RAGASZTÓSZALAG · GLOSS ADHESIVE TAPE · RUBAN ADHÉSIF BRILLANT



19 mm x 33 m

ADAGOLÓVAL
WITH DISPENSER
AVEC DÉVIDOIR

MILAN

CHISLA ADHESIVA BRILLANTE
GLISSO ADHESIVE TAPE
RUBAN ADHÉSIF BRILLANT
KLEBAND GLEBLANT

19mm x 33m

rendelési kód: G14171019

10 x 7,5 x 1,2 cm · 20 gr

8 units · 0,26 kg

192 units · 6,60 kg

80202



8411574802020



MILAN

CHISLA ADHESIVA
ADHESIVE TAPE
RUBAN ADHÉSIF
KLEBAND

19mm x 33m

rendelési kód: MIL000710

10 x 8,5 x 2,3 cm · 48 gr

12 units · 0,61 kg

144 units · 7,50 kg

BWM10433



8411574088370



MILAN

CHISLA ADHESIVA BRILLANTE
GLISSO ADHESIVE TAPE
RUBAN ADHÉSIF BRILLANT
KLEBAND GLEBLANT

19mm x 33m

rendelési kód: MIL000768

18,5 x 8,5 x 2 cm · 74 gr

12 units · 0,92 kg

144 units · 11,40 kg

BWM10480



8411574097679



36 unidades/cajita
units/box
unités/boîte

rendelési kód: G15172000

21 x 15 x 13 cm · 1,65 kg

4 units · 6,80 kg

80217



8411574802174

**FÉNYES ÁTLÁTSZÓ RAGASZTÓSZALAG · GLOSS TRANSPARENT ADHESIVE TAPE
RUBAN ADHÉSIF TRANSPARENT BRILLANT**



19 mm x 33 m

ADAGOLÓVAL
WITH DISPENSER
AVEC DÉVIDOIR

MILAN

CHISLA ADHESIVA TRANSPARENT
BRILLANTE
GLISSO ADHESIVE TAPE
TRANSPARENT BRILLANT
RUBAN ADHÉSIF TRANSPARENT
BRILLANT
KLEBAND TRANSPARENT
GLEBLANT

19mm x 33m

rendelési kód: G14173019

10 x 7,5 x 2 cm · 32 gr

8 units · 0,28 kg

192 units · 6,90 kg

80227



8411574802273



MILAN

CHISLA ADHESIVA TRANSPARENT
BRILLANTE
GLISSO ADHESIVE TAPE
TRANSPARENT BRILLANT
RUBAN ADHÉSIF TRANSPARENT
BRILLANT
KLEBAND TRANSPARENT
GLEBLANT

19mm x 33m

rendelési kód: G15171019

9,9 x 8,5 x 2,3 cm · 47,5 gr

12 units · 0,60 kg

144 units · 7,45 kg

BWM10422



8411574084150



MILAN

CHISLA ADHESIVA TRANSPARENT
BRILLANTE
GLISSO ADHESIVE TAPE
TRANSPARENT BRILLANT
RUBAN ADHÉSIF TRANSPARENT
BRILLANT
KLEBAND TRANSPARENT
GLEBLANT

19mm x 33m

rendelési kód: MIL000769

18,5 x 8,5 x 2 cm · 67 gr

12 units · 0,92 kg

144 units · 11,40 kg

BWM10481



8411574097686



36 unidades/cajita
units/box
unités/boîte

rendelési kód: G15168019

21 x 15 x 13 cm · 1,65 kg

4 units · 6,80 kg

3433D836



8411574095330

MATT LÁTHATATLAN RAGASZTÓSZALAG · MATTE INVISIBLE TAPE
RUBAN INVISIBLE MATE



19 mm x 33 m

ADAGOLÓVAL
WITH DISPENSER
AVEC DÉVIDOIR



rendelési kód: G14172019

10 x 7,5 x 1,5 cm · 31 gr

8 units · 0,33 kg

96 units · 4,20 kg

80211



8411574802112



rendelési kód: G15170019

9,9 x 8,5 x 2,3 cm · 50 gr

12 units · 0,63 kg

144 units · 7,78 kg

BWM10420



8411574083818



rendelési kód: MIL000770

18,5 x 8,5 x 2 cm · 73 gr

12 units · 0,96 kg

144 units · 11,70 kg

BWM10482



8411574097693

36 unidades/cajita
units/box
unités/boîte



rendelési kód: G15169019

21 x 15 x 13 cm · 1,65 kg

4 units · 6,80 kg

3423D836



8411574091080

KÉTOLDALAS RAGASZTÓSZALAG · DOUBLE-SIDED ADHESIVE TAPE · RUBAN ADHÉSIF DOUBLE FACE

**TOP
SELLER**



15 mm x 10 m

ADAGOLÓVAL
WITH DISPENSER
AVEC DÉVIDOIR



rendelési kód: G14173015

10 x 7 x 2 cm · 24 gr

10 units · 0,27 kg

120 units · 3,60 kg

80212



8411574802129



rendelési kód: G15170015

9,9 x 8,5 x 2,3 cm · 48 gr

12 units · 0,61 kg

144 units · 7,48 kg

BWM10421



8411574084143



rendelési kód: MIL000771

18,5 x 8,5 x 2 cm · 72 gr

12 units · 0,85 kg

144 units · 10,50 kg

BWM10483



8411574097709

28 unidades/cajita
units/box
unités/boîte



rendelési kód: G14173K28

12,5 x 12,5 x 11,8 cm · 0,99 kg

4 units · 3,89 kg

3445828



8411574100720

MILAN**CSOMAGZÁRÓGÉP · TAPE DISPENSER · DÉVIDOIRS**

rendelési kód: G15175000



**CSOMAGZÁRÓGÉP
IPARI/RAKTÁRI
HASZNÁLATHOZ**
TAPE DISPENSER FOR
INDUSTRIAL TAPE
DÉROULEUR POUR
RUBAN ADHÉSIF
INDUSTRIEL

23,5 x 19 x 7 cm · 0,40 kg

24 units · 10,10 kg

80222



8411574802228

**KÉTOLDALAS ZSELÉS RAGASZTÓSZALAG · DOUBLE SIDED ADHESIVE GEL TAPE
RUBAN GEL ADHÉSIF DOUBLE FACE**

rendelési kód: G14176030

NEW!

30 mm x 3 m

**NANO MAGIC TAPE**

**KÉTOLDALAS ZSELÉS
RAGASZTÓSZALAG**
DOUBLE SIDED ADHESIVE
GEL TAPE
RUBAN GEL ADHÉSIF
DOUBLE FACE

12,4 x 12,4 x 3,3 cm · 0,20 kg

5 units · 1,02 kg

40 units · 9 kg

34492



8411574105978

RAGASZTÓSZALAG · ADHESIVE TAPE · RUBAN ADHÉSIF

rendelési kód: MIL000022



50 mm x 66 m

ø10,5 x 5 cm · 0,21 kg

6 units · 1,27 kg

72 units · 15,58 kg

80214



8411574802143

**BARNA
IPARI/RAKTÁRI
RAGASZTÓSZALAG**
BROWN INDUSTRIAL
PACKAGING TAPE
RUBAN ADHÉSIF
MARRON POUR
EMBALLAGE INDUSTRIEL

rendelési kód: MIL000248



50 mm x 66 m

ø10,5 x 5 cm · 0,21 kg

6 units · 1,30 kg

72 units · 15,30 kg

3456T



8411574097716

**ÁTLÁTSZÓ
IPARI/RAKTÁRI
RAGASZTÓSZALAG**
TRANSPARENT INDUSTRIAL
PACKAGING TAPE
RUBAN ADHÉSIF
TRANSPARENT
POUR EMBALLAGE
INDUSTRIEL

rendelési kód: G14176050



50 mm x 50 m

ø12 x 5 cm · 0,31 kg

24 units · 7,70 kg

34661



8411574102373

**KRAFT PAPIR
RAGASZTÓSZALAG**
KRAFT PAPER TAPE
RUBAN EN
PAPIER KRAFT



A MILAN számológépek különböző színekben és formátumokban elérhetőek: tudományos, asztali, zseb, védőtökös vagy nagy nyomógombos. Vonzó megjelenést és változatos funkciókat kínál széles választékban. A számológépek működését egy külön minőségellenőrző részleg ellenőrzi és gondoskodik róla, hogy azok megfeleljenek az RoHS irányelvének az elektronikus berendezésekben felhasznált egyes veszélyes anyagokról.

MILAN calculators are available in different colours and formats: scientific, desktop, pocket, case or large key calculators. Attractive designs and a variety of functions in the wide range of MILAN calculators. A specific quality control department checks how the calculators function, as they must comply with the RoHS Directive on the Restriction of the Use of Certain Hazardous Substances in Electrical and Electronic Equipment.

Les calculatrices MILAN sont disponibles en différentes couleurs et formats: calculatrices scientifiques, de bureau, de poche, avec étui ou à grande touches. Styles attrayants et une variété de fonctions dans la large gamme de calculatrices MILAN. Un département spécifique de contrôle de la qualité vérifie le fonctionnement des calculateurs, qui sont conformes à la directive RoHS relative à la restriction de certaines substances dangereuses dans les équipements électriques et électroniques.

SZÁMOLÓGÉPEK
CALCULATORS
CALCULATRICES

TUDOMÁNYOS SZÁMOLÓGÉPEK · SCIENTIFIC CALCULATORS
CALCULATRICES SCIENTIFIQUES



16,7 x 8,4 x 1,9 cm

25,5 x 15 x 4 cm · 0,28 kg

10 units · 3 kg

20 units · 7,10 kg

PATENTED
DESIGN

ENGINEERED
IN SPAIN

M240
240 FUNKCIÓ
240 FUNCTIONS
240 FONCTIONS

BATTERY
SAFE

HARD COVER

DIGIT

RND

STATISTICAL
FUNCTIONS

2 LINE
DISPLAY

RoHS
EU Green
Policy Compliant

A^B/C
FRACTION



ÁTLÁTSZÓ VÉDŐTOK

1918
SERIES

COPPER
SERIES

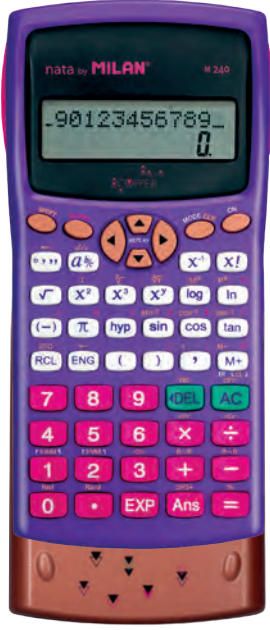

rendelési kód: G27245100



rendelési kód: G27245650



rendelési kód: G27243COP

159110SNCBBL



8411574101970

159110SNCPBL



8411574101987

159110CPBL



8411574080336

TUDOMÁNYOS SZÁMOLÓGÉPEK · SCIENTIFIC CALCULATORS
CALCULATRICES SCIENTIFIQUES



16,7 x 8,4 x 1,9 cm

25,5 x 15 x 4 cm · 0,28 kg

10 units · 3 kg

20 units · 7,10 kg

PATENTED
DESIGN

ENGINEERED
IN SPAIN

M240
240 FUNKCIÓ
240 FUNCTIONS
240 FONCTIONS

BATTERY
SAFE

HARD COVER

2+2
DIGIT

RND

STATISTICAL
FUNCTIONS

2 LINE
DISPLAY

RoHS
EU Green
Policy Compliant

A^B/c
FRACTION

SILVER
SERIES



ÁTLÁTSZÓ VÉDŐTOK



SUNSET
SERIES



CARTON BOX



rendelési kód: MIL000910

21,5 x 8,5 x 3,5 cm ·
0,25 kg

10 units · 2,5 kg

20 units · 5,55 kg

rendelési kód: G27243SIL

159110SL



8411574101994

159110SLBL



8411574080329

CARTON BOX



rendelési kód: G27243SUT

21,5 x 8,5 x 3,5 cm ·
0,25 kg

10 units · 1,7 kg

20 units · 5,55 kg

rendelési kód: G27243SUG

159110SNPR



84115740096085

159110SNRBL



8411574086338



rendelési kód: G27243SUP

159110SNPBL



8411574086321

TUDOMÁNYOS SZÁMOLÓGÉPEK · SCIENTIFIC CALCULATORS
CALCULATRICES SCIENTIFIQUES



16,7 x 8,4 x 1,9 cm
25,5 x 15 x 4 cm · 0,28 kg
10 units · 3 kg
20 units · 7,10 kg

PATENTED DESIGN ENGINEERED IN SPAIN

M240
240 FUNKCIÓ
240 FUNCTIONS
240 FONCTIONS



rendelési kód: G27243500



rendelési kód: G27243200



rendelési kód: G27243300



rendelési kód: G27243400

159110WBL

8411574027539

159110KBL

8411574027522

159110GRBL

8411574037170

159110RBL

8411574040194

TUDOMÁNYOS SZÁMOLÓGÉPEK · SCIENTIFIC CALCULATORS
CALCULATRICES SCIENTIFIQUES

16,7 x 8,4 x 1,9 cm

25,5 x 15 x 4 cm · 0,28 kg

10 units · 3 kg

20 units · 7,10 kg

PATENTED DESIGN

ENGINEERED IN SPAIN

M240
240 FUNKCIÓ
240 FUNCTIONS
240 FONCTIONS



14,3 x 7,4 x 1,4 cm

26 x 16,5 x 2,5 cm · 0,19 kg

12 units · 2,46 kg

24 units · 5,40 kg

PATENTED DESIGN

ENGINEERED IN SPAIN

M228
228 FUNKCIÓ
228 FUNCTIONS
228 FONCTIONS

A SZÁMOLÓGÉP TESTE BIOCIDOT TARTALMAZ. EZÜST-FOSZFÁT ÜVEGGEL
(CAS 308069-39-8) KEZELVE, ANTIBAKTERIÁLIS HATÁSÚ
THE CALCULATOR'S BODY INCORPORATES A BIOCIDAL
(CAS 308069-39-8) WITH ANTIBACTERIAL EFFECT
LE CORPS DE LA CALCULATRICE INCLUT UN BIOCIDAL
D'ARGENT (CAS308069-39-8) AVEC EFFET ANTIBACTÉRIEN



rendelési kód: G2724A150



rendelési kód: G2724A650



rendelési kód: G27244550



rendelési kód: G27244100

159110IBGGRBL



8411574090427

159110IBGPBL



8411574090250

159005YBL



8411574100706

159005BBL



8411574100713

ZSEBSZÁMOLÓGÉPEK · POCKET CALCULATORS · CALCULATRICES DE POCHE

rendelési kód: MIL000187



12 unidades/cajita
units/box
unités/boîte

15 x 11 x 10 cm · 0,53 kg

1 units · 0,58 kg

4 units · 2,65 kg

159512SN

8411574081289



PATENTED DESIGN

9,7 x 6,2
x 0,8 cm



rendelési kód: MIL000190



13 x 6,5 x 1,2 cm · 50 gr

20 units · 1,7 kg

40 units · 3,5 kg

151008SNPR

8411574104490

rendelési kód: MIL000188



18 x 12 x 2 cm · 80 gr

15 units · 1,30 kg

30 units · 2,95 kg

151008SNPRBL

8411574082965

rendelési kód: MIL000189



18 x 12 x 2 cm · 80 gr

15 units · 1,30 kg

30 units · 2,95 kg

151008SNYBL

8411574082972



ZSEBSZÁMOLÓGÉPEK · POCKET CALCULATORS · CALCULATRICES DE POCHE



6 unidades/cajita
units/box
unités/boîte

rendelési kód: G27200SIL

10,7 x 9,6 x 11,2 cm · 0,30 kg

2 units · 0,7 kg

12 units · 4,3 kg

159506SL



8411574067177



SILVER
SERIES

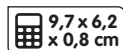

12 unidades/cajita
units/box
unités/boîte

rendelési kód: G27210D01

15 x 11 x 10 cm · 0,53 kg

1 units · 0,58 kg

4 units · 2,65 kg

159912



8411574048824

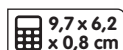

rendelési kód: G27210100



18 x 12 x 2 cm · 93 gr

15 units · 1,60 kg

30 units · 3,60 kg

150908BBL



8411574051084

rendelési kód: G27210300



18 x 12 x 2 cm · 93 gr

15 units · 1,60 kg

30 units · 3,60 kg

150908GBL



8411574051251

rendelési kód: G27210200



18 x 12 x 2 cm · 93 gr

15 units · 1,60 kg

30 units · 3,60 kg

150908KBL



8411574051091

rendelési kód: G27210400



18 x 12 x 2 cm · 93 gr

15 units · 1,60 kg

30 units · 3,60 kg

150908RBL



8411574051237

ZSEBSZÁMOLÓGÉPEK · POCKET CALCULATORS · CALCULATRICES DE POCHE

rendelési kód: G27202600



9,7 x 5,6 x 0,8 cm



16,5 x 9,5 x 2,5 cm · 83 gr

15 units · 1,45 kg

30 units · 3,10 kg

150208OBL



8411574027829

rendelési kód: G27202100

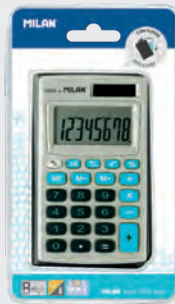

9,7 x 5,6 x 0,8 cm



16,5 x 9,5 x 2,5 cm · 83 gr

15 units · 1,45 kg

30 units · 3,10 kg

150208BBL



8411574027836

rendelési kód: G27202200



9,7 x 5,6 x 0,8 cm



16,5 x 9,5 x 2,5 cm · 83 gr

15 units · 1,45 kg

30 units · 3,10 kg

150208KBL



8411574027812

ASZTALI SZÁMOLÓGÉPEK · DESKTOP CALCULATORS · CALCULATRICES DE BUREAU

rendelési kód: G27200500



12 x 7,8 x 2,1 cm



19,5 x 12,3 x 3 cm · 114 gr

10 units · 1,30 kg

20 units · 3,15 kg

40918BL



8411574020912

rendelési kód: G27226850

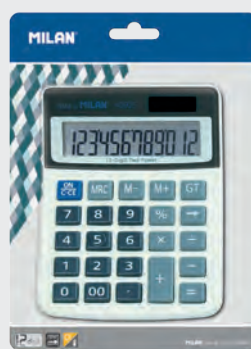

13 x 10 x 1,5 cm



20 x 15 x 4,5cm · 0,16kg

10 units · 1,84 kg

20 units · 4,20 kg

40925BL



8411574021780

rendelési kód: G27208850

PATENTED DESIGN



11,8 x 7,6 x 2,1 cm



19,5 x 12,5 x 3 cm · 108 gr

10 units · 1,30 kg

20 units · 3,05 kg

150808GBL



8411574036487

NAGY NYOMÓGOMBOS ASZTALI SZÁMOLÓGÉPEK · DESKTOP CALCULATORS WITH BIG KEYS · CALCULATRICES DE BUREAU AVEC GRANDES TOUCHES



PATENTED DESIGN

14,5 x 10,6 x 2,8 cm

digit BACK

22 x 14,2 x 4 cm · 0,19 kg

10 units · 2,20 kg

20 units · 4,90 kg



6 unidades/cajita
units/box
unités/boîte

14,5 x 14,5 x 13,5 cm · 0,91 kg

1 units · 0,97 kg

4 units · 4,50 kg

159906

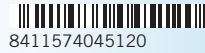

8411574045120

rendelési kód: G27215D01

DUO



rendelési kód: G27215100



CARTON BOX

DUO

19,5 x 11 x 2,8 cm · 170 gr

10 units · 1,8 kg

20 units · 4 kg

150610TDB



8411574104520

rendelési kód: G27215101



150610TDBBL



8411574045038

rendelési kód: G27215301



150610TDGRBL



8411574045113

rendelési kód: G27215600



150610TDOBL



8411574045090

rendelési kód: G27215650



150610TDPBL



8411574045007

NAGY NYOMÓGOMBOS ASZTALI SZÁMOLÓGÉPEK · DESKTOP CALCULATORS WITH BIG KEYS · CALCULATRICES DE BUREAU AVEC GRANDES TOUCHES

rendelési kód: G27204500



14 x 10,4
x 1,5 cm

8 digit

22 x 14 x 3,5 cm · 0,16 kg

10 units · 1,85 kg

20 units · 4,30 kg

151708WBL



8411574032182

rendelési kód: G27204850



14 x 10,4
x 1,5 cm

8 digit

22 x 14 x 3,5 cm · 0,16 kg

10 units · 1,85 kg

20 units · 4,30 kg

151708GBL



8411574032175

rendelési kód: G27204200



14 x 10,4
x 1,5 cm

8 digit

22 x 14 x 3,5 cm · 0,16 kg

10 units · 1,85 kg

20 units · 4,30 kg

151708BL



8411574012023



PATENTED DESIGN

14,5 x 10,6
x 2,8 cm

10 digit

← BACK

6 unidades/cajita
units/box
unités/boîte

rendelési kód: G27215SD1

14,5 x 14,5 x 13,5 cm · 0,91 kg

1 units · 0,97 kg

4 units · 4,50 kg

159906SL

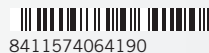

8411574064190

SILVER
SERIES



rendelési kód: G27215S103



PATENTED DESIGN

14,5 x 10,6
x 2,8 cm

10 digit

← BACK

22 x 14,2 x 4 cm · 0,19 kg

10 units · 2,20 kg

20 units · 4,90 kg

159906SLBBL

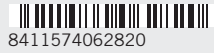

8411574062820

rendelési kód: G27215S650



PATENTED DESIGN

14,5 x 10,6
x 2,8 cm

10 digit

← BACK

22 x 14,2 x 4 cm · 0,19 kg

10 units · 2,20 kg

20 units · 4,90 kg

159906SLPBL



8411574064206

NAGY NYOMÓGOMBOS ASZTALI SZÁMOLÓGÉPEK · DESKTOP CALCULATORS WITH BIG KEYS · CALCULATRICES DE BUREAU AVEC GRANDES TOUCHES



PATENTED DESIGN

LIGHT POWER BATTERY FREE

14,5 x 10,6 x 2,8 cm



6 unidades/cajita
units/box
unités/boîte

rendelési kód: G27216D01

14,5 x 14,5 x 13,5 cm · 0,91 kg

1 units · 0,97 kg

4 units · 4,50 kg

159906ACD

8411574105992



NEW!



LIGHT POWER BATTERY FREE

rendelési kód: G27213100



PATENTED DESIGN

14,5 x 10,6 x 2,8 cm



22,5 x 14 x 4 cm · 0,19 kg

10 units · 2,20 kg

20 units · 4,90 kg

150610BBL

8411574032236

rendelési kód: G27213200



PATENTED DESIGN

14,5 x 10,6 x 2,8 cm



22,5 x 14 x 4 cm · 0,19 kg

10 units · 2,20 kg

20 units · 4,90 kg

150610KBL

8411574032250

NAGY NYOMÓGOMBOS ASZTALI SZÁMOLÓGÉPEK · DESKTOP CALCULATORS WITH BIG KEYS · CALCULATRICES DE BUREAU AVEC GRANDES TOUCHES



rendelési kód: G27232550

PATENTED DESIGN



6 unidades/cajita
units/box
unités/boîte

16,6 x 14,3 x 18,5 cm · 0,97 kg

4 units · 4,50 kg

159706SN



8411574092469

rendelési kód: G27214D06



rendelési kód: G27234108

PATENTED DESIGN



24,5 x 15,5 x 5 cm · 0,22 kg

5 units · 1,25 kg

10 units · 2,90 kg

151812SNPBL



8411574093664



rendelési kód: G27234658

PATENTED DESIGN



24,5 x 15,5 x 5 cm · 0,22 kg

5 units · 1,25 kg

10 units · 2,90 kg

151812SNPRBL



8411574093671



PATENTED DESIGN



24,5 x 15,5 x 5 cm · 0,22 kg

5 units · 1,25 kg

10 units · 2,90 kg

151812IBGGRBL



8411574092452



PATENTED DESIGN



24,5 x 15,5 x 5 cm · 0,22 kg

5 units · 1,25 kg

10 units · 2,90 kg

151812IBGPBL



8411574 093640



A SZÁMOLÓGÉPEK TESTE BIOCIDOT TARTALMAZ. EZÜST-FOSZFÁT ÜVEGGEL (CAS 308069-39-8) KEZELT, ANTIBAKTERIÁLIS HATÁSÚ
THE CALCULATOR'S BODY INCORPORATES A BIOCIDE. TREATED WITH SILVER PHOSPHATE GLASS (CAS 308069-39-8) WITH ANTIBACTERIAL EFFECT
LE CORPS DE LA CALCULATRICE INCLUT UN BIOCIDE. TRAITÉ AU VERRE DE PHOSPHATE D'ARGENT (CAS 308069-39-8) AVEC EFFET ANTIBACTÉRIEN

NAGYMÉRETŰ ASZTALI SZÁMOLÓGÉPEK · LARGE DESKTOP CALCULATORS ·
CALCULATRICES DE BUREAU GRAND FORMAT

rendelési kód: G27221000



- 20 x 16 x 3 cm
- 12 digit
- BACK
-
- M MEMORY KEYS

29,5 x 21,5 x 4,5 cm · 0,38 kg

4 units · 1,65 kg

8 units · 3,70 kg

152512BL



8411574021766

rendelési kód: G27240000

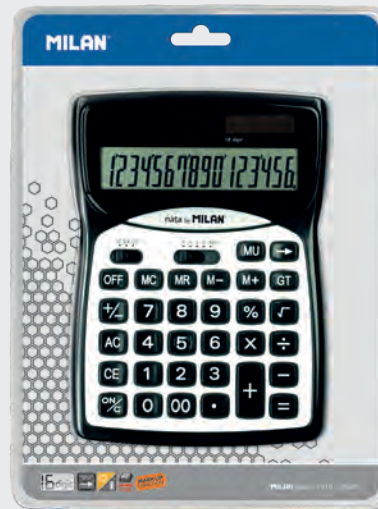

- 18,6 x 13,5 x 3,5 cm
- 15 digit
- BACK
-
- M MEMORY KEYS
- GT GRAND TOTAL

27,5 x 20,5 x 5 cm · 0,34 kg

10 units · 4,00 kg

152016BL



8411574012030

rendelési kód: G27224600



VALUTAVÁLTÁS
CURRENCY CONVERTER
CONVERTISSEUR DE DEVISES



- 17,8 x 12,8 x 2 cm
- 12 digit
- BACK
-
- GT GRAND TOTAL
- M MEMORY KEYS

17,8 x 12,8 x 2 cm · 0,22 kg

20 units · 4,60 kg

80 units · 19,13 kg

1535120



8411574010197

rendelési kód: G27209200



- 22,5 x 14 x 3 cm
- 12 digit
- BACK

26 x 18,5 x 5 cm · 0,27 kg

10 units · 3,20 kg

151712BL



8411574012054

rendelési kód: G27233200



- PATENTED DESIGN**
- 22,5 x 14 x 3 cm
- 12 digit
- BACK

26 x 18,5 x 5 cm · 0,27 kg

10 units · 3,30 kg

150912KBL



8411574046073

**NAGYMÉRETŰ ASZTALI SZÁMOLÓGÉPEK · LARGE DESKTOP CALCULATORS ·
CALCULATRICES DE BUREAU GRAND FORMAT**

rendelési kód: G27228200



23 x 15 x 5 cm · 0,23 kg
10 units · 2,60 kg
20 units · 5,60 kg

152012BL
8411574020936



rendelési kód: G27230400

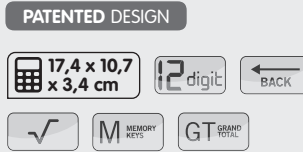

24,7 x 15,4 x 4,7 cm · 0,21 kg
10 units · 2,70 kg

150712RBL
8411574036500



rendelési kód: G27230850



24,7 x 15,4 x 4,7 cm · 0,21 kg
10 units · 2,70 kg

150712GBL
8411574036562



rendelési kód: G27225500



24,8 x 15,5 x 4,5 cm · 0,22 kg
10 units · 2,60 kg

40920BL
8411574021681



rendelési kód: MIL000247



26,5 x 19 x 5,8 cm · 0,35 kg
8 units · 3,20 kg

153012BL
8411574020967



rendelési kód: G27231850



26,5 x 18,5 x 5 cm · 0,32 kg
10 units · 3,70 kg

40924BL
8411574021742



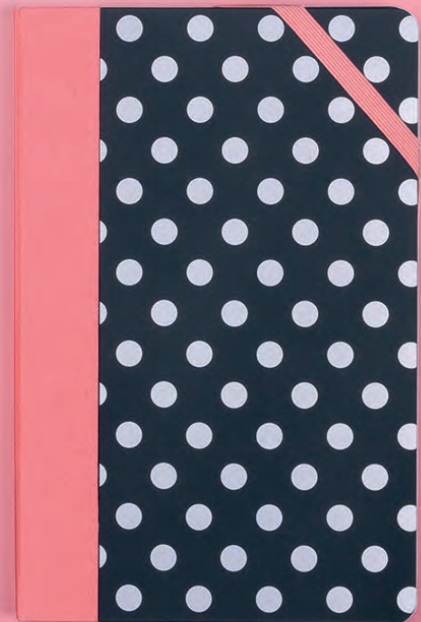

NAPLÓK
NOTEBOOKS
CARNETS

NAPLÓK · PAPERBOOK NOTEBOOKS · CARNETS



5 MM-ES NÉGYZETRÁCSCOS FEHÉR BELÍV
WHITE PAPER with GRID 5 mm
PAPIER BLANC à QUADRILLAGE 5 mm

PONTOZOTT FEHÉR BELÍV
WHITE PAPER with DOTS
PAPIER BLANC à POINTS

SÍMA CSONTSZÍNŰ BELÍV
BLANK IVORY PAPER
PAPIER IVOIRE UNI

VONALAZOTT FEHÉR BELÍV
WHITE PAPER with LINES
PAPIER BLANC à LIGNES

paperbook

PATENTED DESIGN

80gr.

104
208 oldal

208 oldalas, magas minőségű 80 g/m²-es papír.
Contains 208 pages on high quality 80g/m² paper.
Contient 208 pages en papier de 80 g/m², de qualité supérieure.

PLASTIC COVER

Kemény, ellenálló, felületkezelt borítók.
Hard, resistant injected plastic cover.
Couverture en plastique injecté, dur et résistant.

FLAT

A varrott kötésnek köszönhetően teljesen laposra nyitható.
Sewn binding which allows completely flat opening.
Reliure cousue qui permet une ouverture complètement plate.



BELSŐ ZSEB
Inner pocket.
Poche intérieure.



JELZŐSZALAG
Page marker ribbon.
Marque - page.

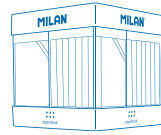

EXPOSITORES
DISPLAYS PG. 274 >
PRÉSENTOIRS

NAPLÓK 2 MÉRETBEN ÉS 4 KÜLÖNBÖZŐ MINTÁVAL · NOTEBOOKS IN 2 SIZES AND 4 DIFFERENT PATTERNS · CARNETS DE 2 DIMENSIONS ET 4 IMPRESSIONS DIFFÉRENTES

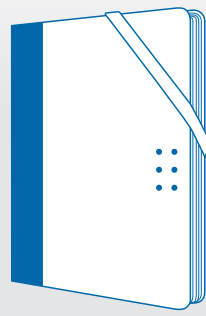

13,8 x 10,3 x 1,6 cm · 0,19 kg

7 units · 1,38 kg

28 units · 5,90 kg



21 x 14 x 1,6 cm · 0,39 kg

5 units · 2,06 kg

20 units · 8,70 kg

NAPLÓK 2 MÉRETBEN ÉS 4 KÜLÖNBÖZŐ MINTÁVAL · NOTEBOOKS IN 2 SIZES AND 4 DIFFERENT PATTERNS · CARNETS DE 2 DIMENSIONS ET 4 IMPRESSIONS DIFFÉRENTES



rendelési kód: A17330006

57064FFGR



8411574061694



rendelési kód: A17330007

57064FFO



8411574061700



rendelési kód: A17330000

57064SL3



8411574067696

Színezett
lapszélek
Coloured paper
edge
Bord du papier
coloré

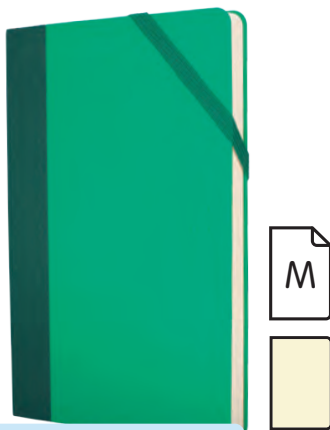

rendelési kód: MIL000347

57051CLGR



8411574060109



rendelési kód: MIL000411

57051CLB



8411574058724

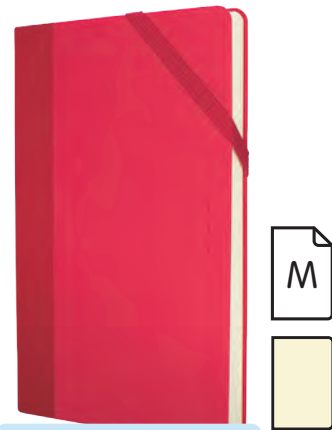

rendelési kód: MIL000346

57051CLR



8411574060116

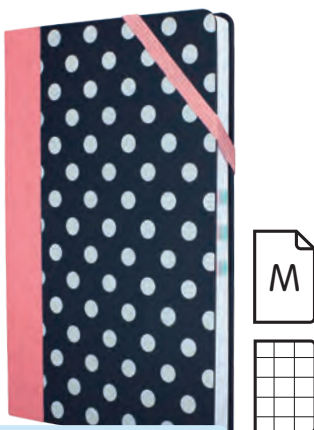

rendelési kód: MIL000603

57053DT



8411574060079

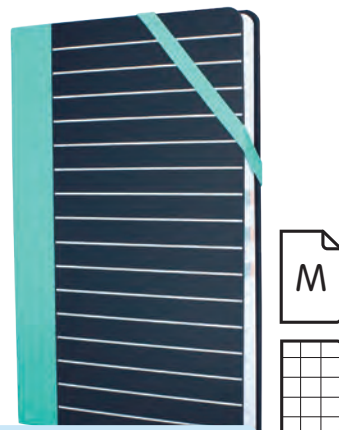

rendelési kód: MIL000604

57053ST



8411574060062



rendelési kód: A17330005

57052FFY



8411574058748

VONALAS SPIRÁLFÜZETEK · SPIRAL NOTEBOOKS WITH LINED PAPER
CAHIERS À SPIRALE LIGNÉ

rendelési kód: MIL000256

29,5 x 24 x 2 cm · 0,74 kg

3 units · 2,2 kg

12 units · 9,68 kg

NEW!



57142E80BG



8411574104834



7 mm

160 oldal

EXPOSITORES
DISPLAYS
PRÉSENTOIRS

PG. 228 >
PG. 273 >

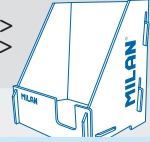

rendelési kód: MIL000252



57142E80B



8411574106234

rendelési kód: MIL000284



57142E80P



8411574104858

rendelési kód: MIL000264



57142E80GR



8411574104872



MILAN
430

Inspired by the original colours and design of **MILAN** erasers, manufactured in Spain since 1918.



NÉZD MEG A VIDEÓT



95 gr/m²-es, magas minőségű, mikroperforált papír 4 lyukasztással.

95 gr/m² paper, high quality, micro-perforated and with 4 holes.

Papier de 95 gr/m², qualité supérieure, microperforé 4 trous.



Könnyen eltávolítható lapok.

Sheets that can be easily removed.

Prédecoupé pour faciliter le détachage de chaque feuille.

NÉGYZETRÁCSOS SPIRÁLFÜZETEK · SPIRAL NOTEBOOKS WITH GRID PAPER · CAHIERS À SPIRALE CARREAUX

rendelési kód: MIL000302



57143E80BG



8411574104827

29,5 x 24 x 2 cm · 0,74 kg

3 units · 2,2 kg

12 units · 9,68 kg

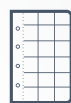

5 x 5 mm 160 oldal

EXPOSITORES
DISPLAYS
PRÉSENTOIRS

PG. 228 >

PG. 273 >

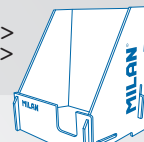

NEW!

rendelési kód: MIL000300



57143E80B



8411574106227

rendelési kód: MIL000306



57143E80P



8411574104841

rendelési kód: MIL000305



57143E80GR



8411574104865



1918
SERIES



Kemény karton borítók. Fényes, dombornyomott logóval.

Covered by rigid cardboard. Embossed logo with glossy finish.

Couverture en carton rigide. Logo en relief finition brillant.

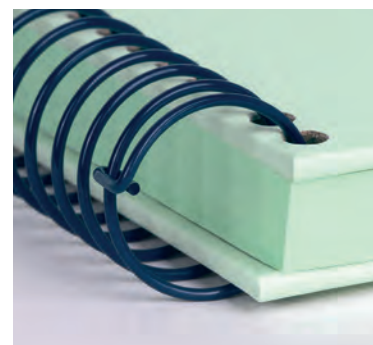
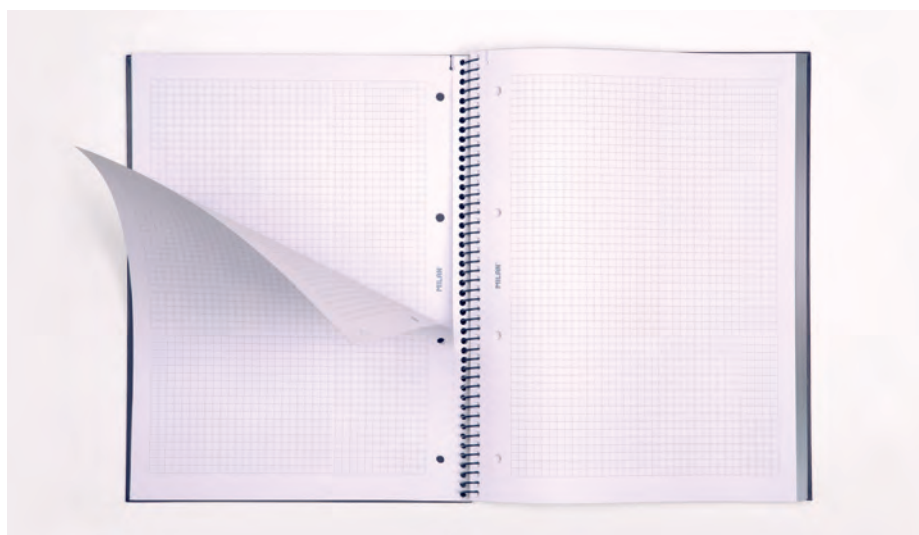

Visszaforduló fém spirálozás.

Metallic spiral with the coil-lock system closure.

Spirale métallique résistante et flexible avec boucle de sécurité.

RAGASZTOTT VONALAS FÜZETEK · NOTEBOOKS WITH GLUED BINDING AND LINED PAPER · CAHIERS RELIURE BROCHURE LIGNÉS

rendelési kód: MIL000316



57242G48BG

 8411574104896

29,7 x 21 x 0,7 cm · 0,35 kg



7 mm 96 oldal

3 units · 1,08 kg

24 units · 9,2 kg

EXPOSITORES
DISPLAYS
PRÉSENTOIRS

PG. 228 >
PG. 273 >

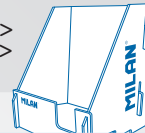

rendelési kód: MIL000310



57242G48B

 8411574106258

rendelési kód: MIL000318



57242G48P

 8411574104919

rendelési kód: MIL000317



57242G48GR

 8411574104933



Inspired by the original colours and design of **MILAN** erasers, manufactured in Spain since 1918.



NÉZD MEG A VIDEÓT



Puha kartonborítás ragasztott kötéssel.
 Flexible cardboard cover with glued binding.
 Couverture en carton souple avec reliure brochure.



Mikroperforált lapok.
 Micro-perforated paper.
 Papier microperforé.

RAGASZTOTT NÉGYZETRÁCSOS FÜZETEK · NOTEBOOKS WITH GLUED BINDING AND GRID PAPER · CAHIERS RELIURE BROCHURE CARREAUX

rendelési kód: MIL000336



57243G48BG
8411574104889

29,7 x 21 x 0,7 cm · 0,35 kg



3 units · 1,08 kg

24 units · 9,2 kg

EXPOSITORES
DISPLAYS
PRÉSENTOIRS

PG. 228 >
PG. 273 >

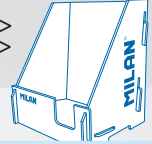

NEW!

rendelési kód: MIL000320



57243G48B
8411574106241

rendelési kód: MIL000339

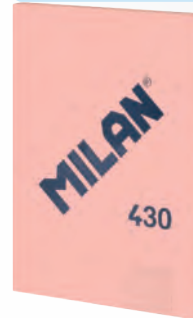

57243G48P
8411574104902

rendelési kód: MIL000338



57243G48GR
8411574104926



1918
SERIES

A papír fenntartható erdőültetvényekből származik.
Paper from sustainable plantations.
Papier provenant de plantations durables.

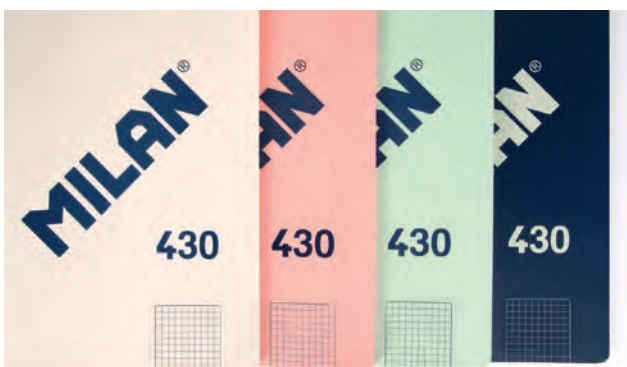

Magas minőségű,
95 g/m²-es papír.

High-quality 95 g/m²
paper.

Papier de 95 gr/m²
qualité supérieure.

Display feltöltéseinkkel kapcsolatban kérjük érdeklődjön vevőszolgálatainknál!

NEW!



A FELHASZNÁLT FA FENNTARTHATÓ ERDŐÜLTETVÉNYEKRŐL SZÁRMAZIK
WOOD FROM SUSTAINABLE PLANTATIONS
BOIS ISSU DE PLANTATIONS DURABLES

RAGASZTÁS- ÉS MŰANYAG RÉSZEKTŐL MENTES
NO ADHESIVES OR PLASTIC PARTS
NE CONTIENT PAS D'ADHÉSIFS NI D'ÉLÉMENTS EN PLASTIQUE

BEMUTATÁSI JAVASLAT
PRESENTATION SUGGESTION
SUGGESTION DE PRÉSENTATION

ÖSSZESZERELÉSI ÚTMUTATÓVAL
ASSEMBLY INSTRUCTIONS INSIDE
INSTRUCTIONS DE MONTAGE INTÉRIEUR

ÖSSZEÁLLÍTHATÓ ÜRES DISPLAY
MOUNTABLE EMPTY DISPLAY
PRÉSENTOIR VIDE, À MONTER

31,5 x 26,5 x 21,7 cm · 0,54 kg

1 unit · 0,76 kg

99192401



8411574108740

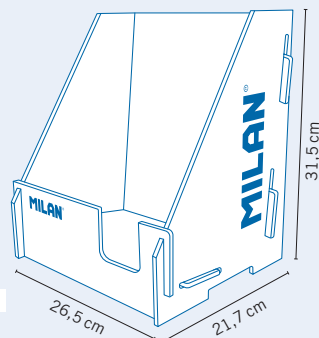

KAPACITÁS · CAPACITY · CAPACITÉ

8u.



18u.



KULCSTARTÓK · KEY-RINGS · PORTE-CLÉS



KEY RING 430

rendelési kód: MIL000176



18 unidades/cajita
units/box
unités/boîte

13 x 13 x 4 cm · 0,43 kg

6 units · 2,70 kg

24 units · 11,30 kg

08592G18



8411574084747

1918
SERIES





KOLLEKCIÓK
COLLECTIONS
COLLECTIONS

IZOTERMIKUS KULACSKOK · ISOTHERMAL BOTTLES · BOUTEILLES ISOTHERMES



COPPER SERIES

SILVER SERIES

SUNSET SERIES

SPECIAL series

591 ml · 20 oz

26,2 x Ø 6,85 cm · 0,27 kg

354 ml · 12 oz

17,1 x Ø 6,85 cm · 0,20 kg



rendelési kód: MIL000609

643020CP



8411574097792



rendelési kód: MIL000439

643020SL

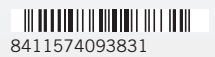

8411574093831



rendelési kód: MIL000434

643020SN

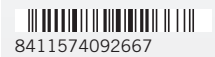

8411574092667



rendelési kód: MIL000441

643020WP

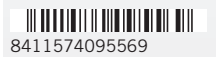

8411574095569



CSÚSZÁSMENTES SZILIKON TALP
NON-SLIP SILICONE BASE
BASE EN SILICONE ANTIDÉRAPANTE



rendelési kód: MIL000610

643012CP



8411574097785



rendelési kód: MIL000447

643012SL



8411574093824



rendelési kód: MIL000448

643012SN



8411574092650



rendelési kód: MIL000444

643012SM



8411574095552

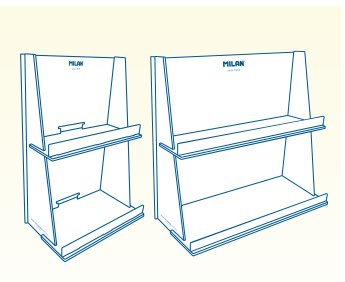

EXPOSITORES
DISPLAYS
PRÉSENTOIRS
PG 275 >

IZOTERMIKUS KULACSKOK · ISOTHERMAL BOTTLES · BOUTEILLES ISOTHERMES



BOTTLES



NÉZD MEG A VIDEÓT



rendelési kód: MIL000437

643020B



8411574092643



rendelési kód: MIL000438

643020P

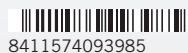

8411574093985



HERMETIKUS KUPAK



DUPLA FALO



PÁRAMENTES



VÁKUM SZIGETELÉS



rendelési kód: MIL000611

643020ACDY



8411574100270

26,6 x 7,1 x 7,1 cm · 0,33 kg

12 units · 4,79 kg

643012ACDB



8411574100263

17,4 x 7,1 x 7,1 cm · 0,25 kg

12 units · 3,68 kg



NEW!

rendelési kód: MIL000418

643020ACDP



8411574106029

rendelési kód: MIL000612



rendelési kód: MIL000451

643012BG



8411574092636



rendelési kód: MIL000452

643012GR



8411574093978

NÉZD MEG A VIDEÓT



1918

SERIES



rendelési kód: MIL000613

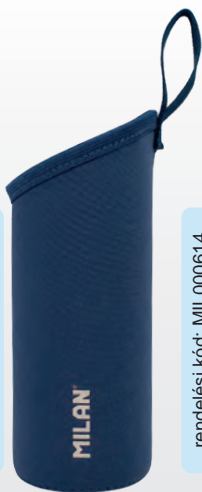

ø 6,5 x 20 cm

64309020



8411574100362

rendelési kód: MIL000614



ø 6,5 x 12 cm

64309012



8411574100355

rendelési kód: MIL000615



ø 6,5 x 20 cm

64309020P



8411574100898

rendelési kód: MIL000616



ø 6,5 x 12 cm

64309012P



8411574100881



AKASZTÓ A JOBB FOGÁS ÉS HORDOZÁS ÉRDEKÉBEN

HANDLE FOR EASY TRANSPORT AND HOLDING.

POIGNÉE POUR FACILITER LE TRANSPORT ET LA TENUE.



KÉNYELMES, CSÚSZÁSMENTES FOGÁST BIZTOSÍT

PROVIDES A COMFORTABLE NON-SLIP GRIP.

OFFRE UNE PRISE EN MAIN CONFORTABLE ET ANTIDÉRAPANTE.

ANYAG ÖSSZETÉTEL: 100% SBR NEOPRÉN POLIÉSZTERREL
 FABRIC COMPOSITION: 100% SBR NEOPRENE WITH POLYESTER
 COMPOSITION DU TISSU: 100% SBR NÉOPRÈNE AVEC POLYESTER



1918 Collection



rendelési kód: MIL000348



rendelési kód: MIL000389



rendelési kód: MIL000351



Inspired by the original colours and design of **MILAN** erasers



41 x 38 x 0,5 cm

62101SNCBG



8411574103684

12.6 l

KÜLSŐ ANYAG
FABRIC EXTERIOR
TISSU EXTÉRIEUR
'RIPSTOP'

BELSŐ ANYAG
INSIDE LINING
DOUBLURE INTÉRIEURE
100% POLYESTER



SZAKADÁSGÁTLÓ SZÖVET
RIPSTOP FABRIC
TISSU RIPSTOP

KÖNNYŰ ÉS ELLENÁLL A SZAKADÁSOKNAK.

Speciális technikával készül, amely rendszeres időközönként vastag, erősített szálakat sző az anyagba keresztvonalas mintázatban.

LIGHT AND RESISTANT TO RIPPING AND TEARING.

Uses a special technique that weaves thick, reinforcement threads at regular intervals in a crosshatch pattern.

LÉGER ET RÉSIANT AUX DÉCHIRURES ET AUX ACCROCS.

Utilise une technique spéciale qui tisse les fils épais de renfort à intervalles réguliers dans un motif entrecroisé.

rendelési kód: MIL000120



rendelési kód: MIL000134



20,5 x 4,5 x 5 cm

081129SNCBG



8411574103608

21 x 8,5 x 6,1 cm

081148SNCBG



8411574103615

2 zseb
pockets
compartments

46,5 x 30 x 17 cm

624604SNCBG



8411574103639

25 l

4 cipzáras rekesz
zips
fermetures éclair

42 x 29 x 11 cm

624302SNCBG



8411574103622

10 l





rendelési kód: MIL000621



23 x 20 x 11 cm

08806SNCGR



8411574096337

3.5 L



KÜLSŐ ANYAG
FABRIC EXTERIOR
TISSU EXTÉRIEUR
'RIPSTOP'

BELSŐ ANYAG
INSIDE LINING
DOUBLURE INTÉRIEURE
100% POLYESTER

BELSŐ IZOTERMIKUS BORÍTÁS
INSIDE ISOTHERMAL LINING
DOUBLURE ISOTHERME
INTÉRIEURE
100% P.E.V.A.

rendelési kód: MIL000622



22 x 12,5 x 12 cm

08805SNCGR



8411574096320

1.5 L



rendelési kód: MIL000636



20 x 9 x 6,7 cm

081145SNCGR



8411574096313

bordázott kemény tok

rendelési kód: MIL000649



37 x 27,5 x 3,5 cm
34,5 x 25 cm (interior)

085156SNCGR



8411574096368

14"

bordázott kemény tok



rendelési kód: MIL000127



22 x 12 x 4 cm

081133SNCGR



8411574098539

5 zseb pockets compartments



rendelési kód: MIL000634



20,5 x 4,5 x 5 cm

081129SNCGR



8411574098522

rendelési kód: MIL000635



21 x 8,5 x 6,1 cm

081148SNCGR



8411574096306

2 zseb pockets compartments



1918 Collection



Inspired by the original colours and design of MILAN® erasers

MILAN®
430

rendelési kód: MIL000349



41 x 38 x 0,5 cm

62101SNCGR



8411574101628

12.6 L



rendelési kód: MIL000160



42 x 34 x 0,7 cm

08420SNCGR



8411574101406

12 L



rendelési kód: MIL000652

rendelési kód: MIL000650



41 x 30 x 18 cm

624605SNCGR



8411574096351

22 L

2 cipzáras rekesz
zíps
fermetures éclair



46,5 x 30 x 17 cm

624604SNCGR



8411574098096

25 L

4 cipzáras rekesz
zíps
fermetures éclair

rendelési kód: MIL000654



42 x 29 x 11 cm

624302SNCGR



8411574096344

10 L



SZAKADÁSGÁTLÓ SZÖVET
RIPSTOP FABRIC
TISSU RIPSTOP

BELSŐ IZOTERMIKUS BORÍTÁS
ISOTHERMAL INSIDE LINING
DOUBLURE INTÉRIEURE ISOTHERME
100% P.E.V.A.



rendelési kód: MIL000155



24 x 13 x 10 cm

08149SNCB



8411574104322

5 zseb
pockets
compartiments

rendelési kód: MIL000628



20 x 9 x 6,7 cm

081145SNCB



8411574096382

**bordázott
kemény tok**

rendelési kód: MIL000625



22 x 12 x 4 cm

081133SNCB



8411574098553

5 zseb
pockets
compartiments

rendelési kód: MIL000623



24,5 x 20 x 15 cm

08808SNCB



8411574096412

5 L

rendelési kód: MIL000617



23 x 20 x 11 cm

08806SNCB



8411574096405

3.5 L



rendelési kód: MIL000618



22 x 12,5 x 12 cm

08805SNCB



8411574096399

1.5 L



rendelési kód: MIL000637

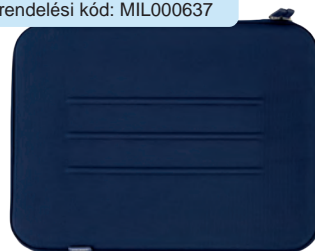

37 x 27,5 x 3,5 cm
34,5 x 25 cm (interior)

085156SNCB



8411574096443

14"

**bordázott
kemény tok**

rendelési kód: MIL000172

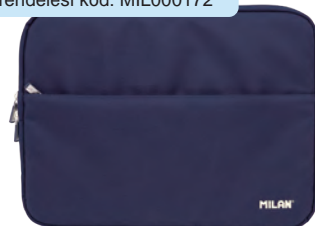

34,5 x 26 x 2,5 cm
32,5 x 24 cm (interior)

085152SNCB



8411574103707

13"

rendelési kód: MIL000626



20,5 x 4,5 x 5 cm

081129SNCB



8411574098546

rendelési kód: MIL000627

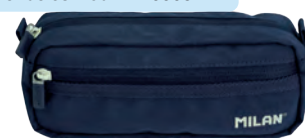

21 x 8,5 x 6,1 cm

081148SNCB



8411574096375

2 zseb
pockets
compartiments



1918 Collection



rendelési kód: MIL000345



rendelési kód: MIL000159



rendelési kód: MIL000638



rendelési kód: MIL000640



Inspired by the original colours and design of MILAN erasers

NEW!



41 x 38 x 0,5 cm

62101SNCB



8411574106555

12.6 L

42 x 34 x 0,7 cm

08420SNCB



8411574101390

12 L

41 x 30 x 18 cm

624605SNCB



8411574096436

22 L

2 cipzáras rekesz
ZIPS
fermetures éclair

rendelési kód: MIL000639



46,5 x 30 x 17 cm

624604SNCB



8411574096856

25 L

4 cipzáras rekesz
ZIPS
fermetures éclair

rendelési kód: MIL000641



52 x 34,5 x 23 cm

625601SNCB



8411574096450

25 L

6 cipzáras rekesz
ZIPS
fermetures éclair

42 x 29 x 11 cm

624302SNCB



8411574096429

10 L



rendelési kód: MIL000156



rendelési kód: MIL000632



rendelési kód: MIL000128



24 x 13 x 10 cm

08149SNCP



8411574104339

5 zseb
pockets
compartments

20 x 9 x 6,7 cm

081145SNCP

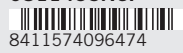

8411574096474

**bordázott
kemény tok**

22 x 12 x 4 cm

081133SNCP



8411574098577

5 zseb
pockets
compartments

rendelési kód: MIL000624



24,5 x 20 x 15 cm

08808SNCP



8411574096504

5 L



rendelési kód: MIL000619

23 x 20 x 11 cm

08806SNCP



8411574096498

3.5 L

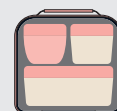

22 x 12,5 x 12 cm

08805SNCP



8411574096481

1.5 L



rendelési kód: MIL000620

rendelési kód: MIL000643

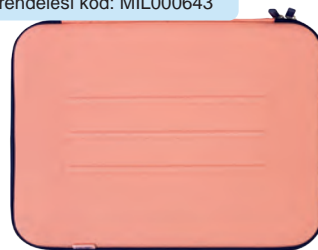

37 x 27,5 x 3,5 cm
34,5 x 25 cm (interior)

085156SNCP



8411574096535

14"

**bordázott
kemény tok**

rendelési kód: MIL000173



34,5 x 26 x 2,5 cm
32,5 x 24 cm (interior)

085152SNCP



8411574103691

13"

rendelési kód: MIL000630



20,5 x 4,5 x 5 cm

081129SNCP



8411574098560

rendelési kód: MIL000631



21 x 8,5 x 6,1 cm

081148SNCP



8411574096467

2 zseb
pockets
compartments



Inspired by the original
colours and design of
MILAN erasers



1918 Collection



rendelési kód: MIL000397

rendelési kód: MIL000350



41 x 38 x 0,5 cm

62101SNCP



8411574101611

12.6 L

rendelési kód: MIL000161



42 x 34 x 0,7 cm

08420SNCP



8411574101413

12 L



rendelési kód: MIL000644



41 x 30 x 18 cm

624605SNCP



8411574096528

22L

2 cipzáras rekesz
zíps
fermetures éclair

52 x 34,5 x 23 cm

25L

6 cipzáras rekesz
zíps
fermetures éclair

625601SNCP



8411574096542

rendelési kód: MIL000645



46,5 x 30 x 17 cm

624604SNCP



8411574098102

25 L

4 cipzáras rekesz
zíps
fermetures éclair

rendelési kód: MIL000646



42 x 29 x 11 cm

624302SNCP



8411574096511

10 L

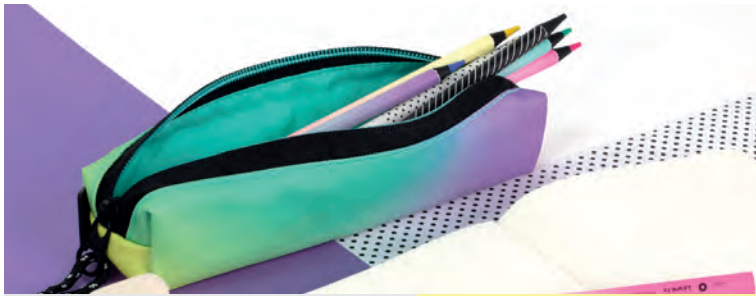

KÜLSŐ ANYAG
FABRIC EXTERIOR
TISSU EXTÉRIEUR
'RIPSTOP' + 100% POLYESTER

BELSŐ ANYAG
INSIDE LINING
DOUBLURE INTÉRIEURE
100% POLYESTER

BELSŐ IZOTERMIKUS BORÍTÁS
ISOTHERMAL INSIDE LINING
DOUBLURE INTÉRIEURE ISOTHERME
100% P.E.V.A.



SZAKADÁSGÁTLÓ SZÖVET
RIPSTOP FABRIC
TISSU RIPSTOP

KÖNNYŰ ÉS ELLENÁLL A SZAKADÁSOKNAK.

Speciális technikával készül, amely rendszeres időközönként vastag, erősített szálakat sző az anyagba keresztvonalas mintázatban.

LIGHT AND RESISTANT TO RIPPING AND TEARING.
Uses a special technique that weaves thick, reinforcement threads at regular intervals in a crosshatch pattern.

LÉGER ET RÉSIANT AUX DÉCHIRURES ET AUX ACCROCS.
Utilise une technique spéciale qui tisse les fils épais de renfort à intervalles réguliers dans un motif entrecroisé.



rendelési kód: MIL000690



20,5 x 4,5 x 5 cm

081129SN1GR



8411574098249

rendelési kód: MIL000689



23 x 9 x 1,5 cm

081118SN1GR



8411574098232

rendelési kód: MIL000686



20,5 x 9 x 5,5 cm

081130SN1GR



8411574098256

rendelési kód: MIL000126



22 x 12 x 4 cm

081133SN1GR



8411574098263

5 zseb
pockets
compartments

rendelési kód: MIL000687



22 x 11 x 6,5 cm

081135SN1GR



8411574098270

3 zseb
pockets
compartments

rendelési kód: MIL000139



19,5 x 13 x 5 cm

081264SN1GR



8411574098287

rendelési kód: MIL000147



19,5 x 13 x 7,5 cm

081364SN1GR



8411574098294

rendelési kód: MIL000236



22,5 x 11,5 x 11 cm

08872SN1GR



8411574098331



rendelési kód: MIL000685



43 x 30 x 20 cm

624605SN1GR

8411574098355

22 L

2 cipzáras rekesz
zíps
fermetures éclair

rendelési kód: MIL000174



30 x 15 x 8,5 cm

08530SN1GR

8411574098317

rendelési kód: MIL000171



34,5 x 26 x 2,5 cm
32,5 x 24 cm (interior)

085152SN1GR

8411574098300

13"

rendelési kód: MIL000183



22 x 12,5 x 12 cm

08805SN1GR

8411574101048

1.5 L



rendelési kód: MIL000907



23 x 20 x 11 cm

08806SN1GR

8411574101055

3.5 L



rendelési kód: MIL000684



24,5 x 20 x 16 cm

08808SN1GR

8411574098348

5 L

green

SUNSET
COLLECTION





rendelési kód: MIL000677



20,5 x 4,5 x 5 cm

081129SN1P



8411574098133

rendelési kód: MIL000676



23 x 9 x 1,5 cm

081118SN1P



8411574098126

rendelési kód: MIL000672



20,5 x 9 x 5,5 cm

081130SN1P



8411574098140

rendelési kód: MIL000675



22 x 12 x 4 cm

081133SN1P



8411574098157

5 zseb
pockets
compartments

rendelési kód: MIL000674



22 x 11 x 6,5 cm

081135SN1P



8411574098164

3 zseb
pockets
compartments



rendelési kód: MIL000140



19,5 x 13 x 5 cm

081264SN1P



8411574098171



rendelési kód: MIL000148



19,5 x 13 x 7,5 cm

081364SN1P



8411574098188



rendelési kód: MIL000237



22,5 x 11,5 x 11 cm

08872SN1P



8411574098218



pink



rendelési kód: MIL000669



34,5 x 26 x 2,5 cm
32,5 x 24 cm (interior)

085152SN1P

8411574098195

13"



rendelési kód: MIL000175



30 x 15 x 8,5 cm

08530SN1P

8411574098201



rendelési kód: MIL000671



43 x 30 x 20 cm

624605SN1P

8411574098225

22L

2 cipzáras rekesz
zíps
fermetures éclair

rendelési kód: MIL000184



22 x 12,5 x 12 cm

08805SN1P

8411574101062

1.5L

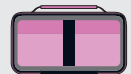

rendelési kód: MIL000396



52 x 34,5 x 23 cm

625601SN1P

8411574102526

25L

6 cipzáras rekesz
zíps
fermetures éclair

rendelési kód: MIL000192



23 x 20 x 11 cm

08806SN1P

8411574101079

3.5L



rendelési kód: MIL000203



24,5 x 20 x 16 cm

08808SN1P

8411574101086

5L



rendelési kód: MIL000664



20,5 x 4,5 x 5 cm

081129SNK1



8411574097815

rendelési kód: MIL000663



23 x 9 x 1,5 cm

081118SNK1



8411574097808

rendelési kód: MIL000129



22 x 12 x 4 cm

081133SNK1



8411574097839

5 zseb
pockets
compartiments

rendelési kód: MIL000661



22 x 11 x 6,5 cm

081135SNK1



8411574097846

3 zseb
pockets
compartiments

rendelési kód: MIL000660



20,5 x 9 x 5,5 cm

081130SNK1



8411574097822



rendelési kód: MIL000143



19,5 x 13 x 5 cm

081264SNK1P



8411574097853

rendelési kód: MIL000141



19,5 x 13 x 5 cm

081264SNK1GR



8411574097860

rendelési kód: MIL000667



19,5 x 13 x 7,5 cm

081364SNK1



8411574097877

rendelési kód: MIL000238

22,5 x 11,5 x 11 cm

08872SNK1



8411574097907



black

rendelési kód: MIL000383



45 x 30 x 12 cm

624601SNK1



8411574102533

21 L

2 cipzáras rekesz
zíps
fermetures éclair

rendelési kód: MIL000659



43 x 30 x 20 cm

624605SNK1



8411574097921

22 L

2 cipzáras rekesz
zíps
fermetures éclair

rendelési kód: MIL000655



48 x 34 x 16 cm

624604SNK1



8411574100867

25 L

4 cipzáras rekesz
zíps
fermetures éclair

rendelési kód: MIL000656



34,5 x 26 x 2,5 cm
32,5 x 24 cm (interior)

085152SNK1



8411574097884

13"

rendelési kód: MIL000657



30 x 15 x 8,5 cm

08530SNK1



8411574097891

rendelési kód: MIL000154



13 x 24 x 10 cm

08149SN



8411574104315

5 zseb
pockets
compartiments

rendelési kód: MIL000185



22 x 12,5 x 12 cm

08805SNK1



8411574101024

1.5 L



rendelési kód: MIL000908



23 x 20 x 11 cm

08806SNK1



8411574101031

3.5 L



rendelési kód: MIL000658



24,5 x 20 x 16 cm

08808SNK1



8411574097914

5 L

MILAN®

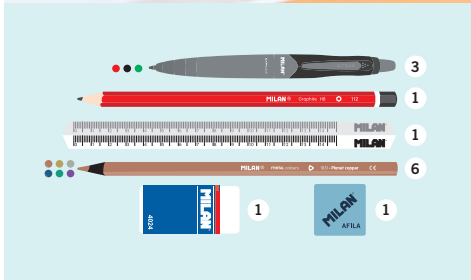

rendelési kód: MIL000241

bordázott kemény tok



21,5 x 13,5 x 6,5 cm

08874FN



8411574099598



ANYAG ÖSSZETÉTEL:
KÜLSŐ ÉS BELSŐ BORÍTÁS 100% POLIÉSZTER

FABRIC COMPOSITION:
EXTERIOR AND INSIDE LINING 100% POLYESTER

COMPOSITION DU TISSU:
EXTÉRIEUR ET DOUBLURE INTÉRIEURE 100% POLYESTER



3 cipzáras rekesz
zips
fermetures éclair

22 L



rendelési kód: MIL000702

43 x 30 x 20 cm

624605FN



8411574099604

5 zseb
pockets
compartments



rendelési kód: MIL000125

22 x 12 x 4 cm

081133FN



8411574099536



rendelési kód: MIL000698

20,5 x 4,5 x 5 cm

081129FN



8411574099529



**THE
FUN**
COLLECTION

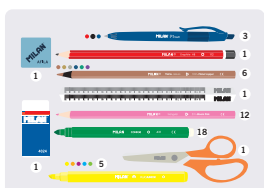

rendelési kód: MIL000699

19,5 x 13 x 7,5 cm

081364FN



8411574100324

3.5 L



rendelési kód: MIL000700

23 x 20 x 11 cm

08806FN



8411574099574

bordázott
kemény tok



rendelési kód: MIL000694

20 x 9 x 6,7 cm

081145FN



8411574099550

3 zseb
pockets
compartments

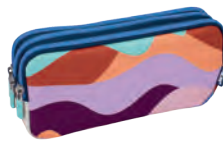

rendelési kód: MIL000696

22 x 11 x 6,5 cm

081135FN



8411574099543

10 L



rendelési kód: MIL000701

42 x 29 x 11 cm

624302FN



8411574099611



ANYAG ÖSSZETÉTEL:
KÜLSŐ ÉS BELSŐ BORÍTÁS 100%
POLIÉSZTER

FABRIC COMPOSITION:
EXTERIOR AND INSIDE LINING 100%
POLYESTER

COMPOSITION DU TISSU:
EXTÉRIEUR ET DOUBLURE INTÉRIEURE 100%
POLYESTER

1.5 L



5 L

2 zseb
pockets
compartments



rendelési kód: MIL000703

rendelési kód: MIL000704

rendelési kód: MIL000706

rendelési kód: MIL000707

rendelési kód: MIL000708

22 x 12,5 x 12 cm

24,5 x 20 x 16 cm

20,5 x 9 x 5,5 cm

21 x 8,5 x 6,1 cm

23 x 9 x 1,5 cm

08805FNB

08808FNB

081130FNB

081148FNB

081118FNB



8411574099666

8411574099680

8411574099635

8411574099642

8411574099628

THE
FUN
COLLECTION

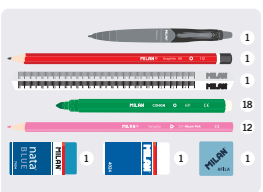

4 cipzáras rekesz
zíps
fermetures éclair

25 L

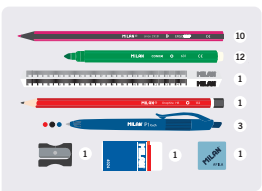

13"



rendelési kód: MIL000205

rendelési kód: MIL000168

rendelési kód: MIL000711

rendelési kód: MIL000712

22,5 x 11,5 x 11 cm

34,5 x 26 x 2,5 cm
32,5 x 24 cm (interior)

19,5 x 13 x 5 cm

48 x 34 x 16 cm

08872FNB

085152FN

081264FNB

624604FNB



8411574099697

8411574100744

8411574100331

8411574099703



ANYAG ÖSSZETÉTEL:

KÜLSŐ ÉS BELSŐ BORÍTÁS 100% POLIÉSZTER

FABRIC COMPOSITION: EXTERIOR AND INSIDE LINING 100% POLYESTER

COMPOSITION DU TISSU: EXTÉRIEUR ET DOUBLURE INTÉRIEURE 100%

POLYESTER

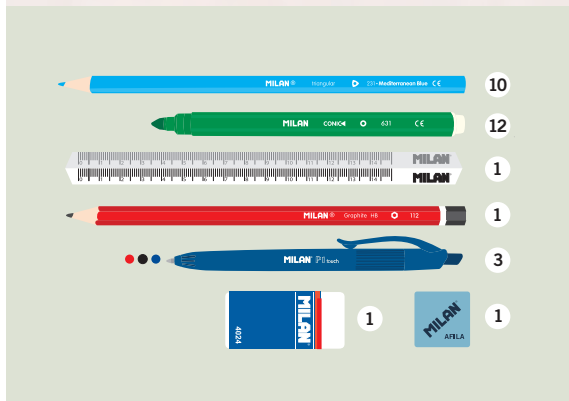

rendelési kód: MIL000204

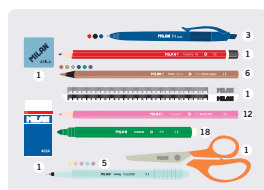

rendelési kód: MIL000145

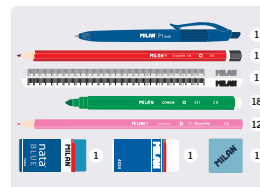

rendelési kód: MIL000136

3 zseb pockets compartments



rendelési kód: MIL000130

22,5 x 11,5 x 11 cm

08872DN



8411574102069

19,5 x 13 x 7,5 cm

081364DN



8411574102052

19,5 x 13 x 5 cm

081264DN



8411574102045

22 x 11 x 6,5 cm

081135DN



8411574102038

DINÖS

COLLECTION



rendelési kód: MIL000158



33 x 24 x 12,5 cm

0841DN



8411574102083

9.9 L

6 cipzáras rekesz
zipt
fermeture éclair

25 L

5 zseb
pockets
compartments



rendelési kód: MIL000124

22 x 12 x 4 cm

081133DN



8411574102021

5 L



rendelési kód: MIL000909

24,5 x 20 x 16 cm

08808DN



8411574102076



rendelési kód: MIL000392

52 x 34,5 x 23 cm

625601DN



8411574102090



rendelési kód: MIL000390

4 cipzáras rekesz
zíps
fermetures éclair

25 L



48 x 34 x 16 cm

624604TN



8411574105329

rendelési kód: MIL000414

6 cipzáras rekesz
zíps
fermetures éclair

25 L

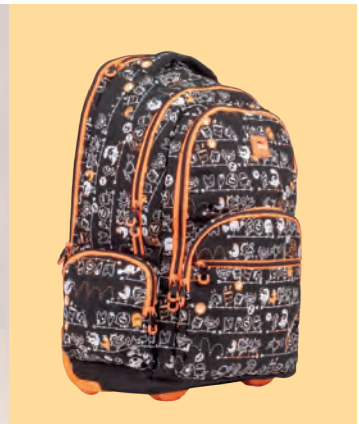

52 x 34,5 x 23 cm

625601TN



8411574105336

ANYAG ÖSSZETÉTEL:
KÜLSŐ ÉS BELSŐ BORÍTÁS 100% POLIÉSZTER

FABRIC COMPOSITION:
EXTERIOR AND INSIDE LINING 100% POLYESTER

COMPOSITION DU TISSU:
EXTÉRIEUR ET DOUBLURE INTÉRIEURE 100% POLYESTER

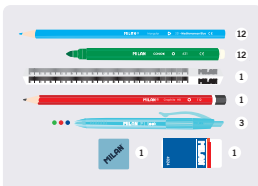

rendelési kód: MIL000240

22,5 x 11,5 x 11 cm

08872TN



8411574105312

2 zseb
pockets
compartments



rendelési kód: MIL000135

21 x 8,5 x 6,1 cm

081148TN



8411574105275



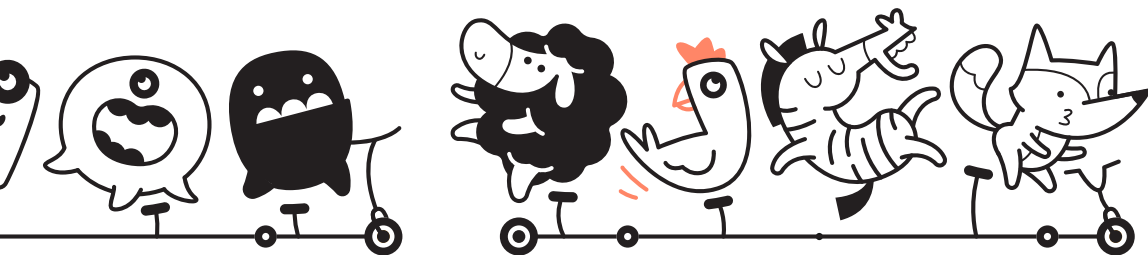

TANDEM
COLLECTION



- 1 MILAN 3
- 1 MILAN 1
- 1 MILAN 6
- 1 MILAN 1
- 1 MILAN 12
- 1 MILAN 18
- 1 MILAN 5
- 1 MILAN 1

- 1 MILAN 1
- 1 MILAN 1
- 1 MILAN 1
- 18 MILAN 18
- 12 MILAN 12
- 1 MILAN 1
- 1 MILAN 1
- 1 MILAN 1



rendelési kód: MIL000149

19,5 x 13 x 7,5 cm

081364TN



8411574105305



rendelési kód: MIL000123

20,5 x 9 x 5,5 cm

081130TN



8411574105268

5 zseb
pockets
compartments



rendelési kód: MIL000157

24 x 13 x 10 cm

08149TN



8411574105282



rendelési kód: MIL000144

19,5 x 13 x 5 cm

081264TN



8411574105299



3 zseb
pockets
compartments



rendelési kód: MIL000121

20,5 x 9 x 5,5 cm

081130FI



8411574105343



rendelési kód: MIL000131

22 x 11 x 6,5 cm

081135FI



8411574105350



rendelési kód: MIL000150

21 x 11,5 x 8 cm

08146FI



8411574105367





ANYAG ÖSSZETÉTEL:
KÜLSŐ ÉS BELSŐ BORÍTÁS 100%
POLIÉSZTER

FABRIC COMPOSITION:
EXTERIOR AND INSIDE LINING 100%
POLYESTER

COMPOSITION DU TISSU:
EXTÉRIEUR ET DOUBLURE
INTÉRIEURE 100% POLYESTER

Fireflies

COLLECTION



13"



rendelési kód: MIL000167

34,5 x 26 x 2,5 cm
32,5 x 24 cm (interior)

085152FI



8411574105374

2 cipzáras rekesz
zíps
fermetures éclair

21 L



rendelési kód: MIL000382

5 L



rendelési kód: MIL000201

24,5 x 20 x 16 cm

08808FI



8411574105381



5 compartimentos
pockets
compartiments



rendelési kód: MIL000151

24 x 13 x 10 cm

08149RL



8411574104964



ANYAG ÖSSZETÉTEL:
KÜLSŐ ÉS BELSŐ BORÍTÁS 100% POLIÉSZTER

FABRIC COMPOSITION:
EXTERIOR AND INSIDE LINING 100% POLYESTER

COMPOSITION DU TISSU:
EXTÉRIEUR ET DOUBLURE INTÉRIEURE 100%
POLYESTER

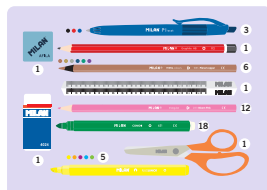

rendelési kód: MIL000146

19,5 x 13 x 7,5 cm

081364RL



8411574104988

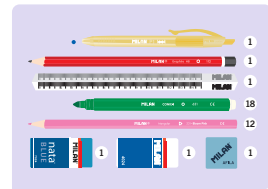

rendelési kód: MIL000138

19,5 x 13 x 5 cm

081264RL



8411574104971



4 cipzáras rekesz
zíps
fermetures éclair



6 cipzáras rekesz
zíps
fermetures éclair

25 L



rendelési kód: MIL000386

48 x 34 x 16 cm

624604RL



8411574105008

2 zseb
pockets
compartiments



rendelési kód: MIL000235

22,5 x 11,5 x 11 cm

08872RL



8411574104995

rendelési kód: MIL000133

21 x 8,5 x 6,1 cm

081148RL



8411574104957

25 L



rendelési kód: MIL000393

52 x 34,5 x 23 cm

625601RL



8411574105015



ANYAG ÖSSZETÉTEL:
KÜLSŐ ÉS BELSŐ BORÍTÁS 100% POLIÉSZTER

FABRIC COMPOSITION:
EXTERIOR AND INSIDE LINING 100% POLYESTER

COMPOSITION DU TISSU:
EXTÉRIEUR ET DOUBLURE INTÉRIEURE 100%
POLYESTER



1.5 L



rendelési kód: MIL000177

22 x 12,5 x 12 cm

08805FZ



8411574102595

3.5 L



rendelési kód: MIL000186

23 x 20 x 11 cm

08806FZ



8411574102618

5 L



rendelési kód: MIL000202

24,5 x 20 x 16 cm

08808FZ



8411574102601



rendelési kód: MIL000122

20,5 x 9 x 5,5 cm

081130FZ



8411574102557



rendelési kód: MIL000119

23 x 9 x 1,5 cm

081118FZ



8411574102540



FIZZ

COLLECTION

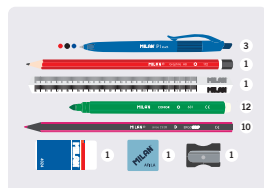

3 zseb
pockets
compartiments

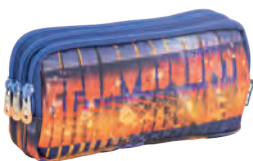

13"

4 cipzáras rekesz
zíps
fermetures éclair

3 cipzáras rekesz
zíps
fermetures éclair

25 L



22 L



rendelési kód: MIL000132

rendelési kód: MIL000206

rendelési kód: MIL000169

rendelési kód: MIL000385

rendelési kód: MIL000391

22 x 11 x 6,5 cm

22,5 x 11,5 x 11 cm

34,5 x 26 x 2,5 cm
32,5 x 24 cm (interior)

48 x 34 x 16 cm

43 x 30 x 20 cm

081135FZ



8411574102564

08872FZ



8411574102588

085152FZ



8411574103028

624604FZ



8411574102625

624605FZ



8411574102632

UZSONNÁS DOBOZOK · FOOD CONTAINERS · BOÎTES ALIMENTAIRES

PATENTED DESIGN

0.25L

ø 10 x 7 cm · 75 gr

16 units · 1,45 kg

HERMETIKUS
HERMETIC
HERMÉTIQUE

CSAVAROS TETŐ
SCREW LID
COUVERCLE À VIS



085112Y

rendelési kód: MIL000166



085112PR

rendelési kód: MIL000164



085112TQ

rendelési kód: MIL000165

SUNSET
SERIES



085112BT

rendelési kód: MIL000766



085112RNB

rendelési kód: MIL000767

THE
FUN
SERIES



085112P

rendelési kód: MIL000352



085112GR

rendelési kód: MIL000356



085112B

rendelési kód: MIL000357

1918
SERIES

0.33L

10 x 10 x 7,4 cm · 97 gr

16 units · 1,45 kg



085111W

rendelési kód: MIL000358



085111P

rendelési kód: MIL000334



085111GR

rendelési kód: MIL000333



085111LB

rendelési kód: MIL000335

1918
SERIES

0.75L

20,6 x 10 x 7,4 cm · 0,20 kg

8 units · 2 kg

NEW!

SUNSET
SERIES

1918
SERIES



085110PR

rendelési kód: MIL000162



085110TQ

rendelési kód: MIL000163



085110P

rendelési kód: MIL000332



085110GR

rendelési kód: MIL000331



085110B

rendelési kód: MIL000359

BPA FREE



Az újrafelhasználható palackok és tárolóedények használata hozzájárul az egyszerűhasználatos, eldobható palackok és ételtartók műanyagfogyasztásának csökkentéséhez.

The use of reusable bottles and food containers contributes to reducing the plastic consumption of single-use disposable bottles and food containers.

L'utilisation de bouteilles et boîtes alimentaires réutilisables contribue à réduire la consommation de plastique des bouteilles et boîtes alimentaires à usage unique.





**DISPLAYEK ÉS BLISZTERES
TERMÉKEK**
DISPLAYS AND BLISTER PACKS
PRÉSENTOIRS ET BLISTERS

DISPLAYEK · DISPLAYS · PRÉSENTOIRS

Display feltöltéseinkkel kapcsolatban kérjük érdeklődjön vevőszolgálatainknál!

TÁROLÓ RÉSZ
STORAGE SPACE
ESPACE DE STOCKAGE



KAPACITÁS · CAPACITY · CAPACITÉ

16 u. **PMM1012CF-16**

SZINETIKUS RADÍR
SYNTHETIC FRIABLE RUBBER
CAOUTCHOUC SYNTHÉTIQUE

1



36 u. **PNM4836RCF**

FLEXIBILIS SZINETIKUS RADÍR
FLEXIBLE SYNTHETIC RUBBER
CAOUTCHOUC SYNTHÉTIQUE FLEXIBLE

2



17 u. **CPM5020**

TOP GRAPHIC

3



17 u. **CMM4020**

SZINETIKUS RADÍR
SYNTHETIC FRIABLE RUBBER
CAOUTCHOUC SYNTHÉTIQUE

1



20 u. **CPM6020**

nata

3



FELTÖLTÉSI JAVASLAT
PRESENTATION SUGGESTION
SUGGESTION DE PRÉSENTATION

EGYESÉVEL CSOMAGOLT
INDIVIDUALLY WRAPPED
EMBALLÉES INDIVIDUELLEMENT

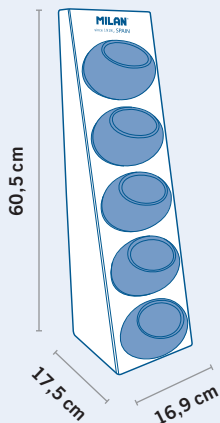

ÜRES DISPLAY
EMPTY DISPLAY
PRÉSENTOIR VIDE

60,5 x 17,5 x 16,9 cm · 1,03 kg

1 unit · 1,55 kg

ZVM10144



8411574067498

TARTALOM

CONTENT
CONTENU

27,5 x 23,5 x 10,5 cm

1 unit · 4,68 kg

99561601



8411574067559

KIEGÉSZÍTŐ MATRICA A DISPLAYHEZ

STICKERS TO APPLY ON THE DISPLAY
ETIQUETTES POUR INDiquer LES PRIX

4 x 3,3 cm

ZDM10147



8411574067580

2 doboz

PMM1012CF-16

2 doboz

PNM4836RCF

2 doboz

CPM5020

2 doboz

CMM4020

2 doboz

CPM6020

MILAN

DISPLAYEK · DISPLAYS · PRÉSENTOIRS

NEW!



FORGÓ ÁLLVÁNY
SWIVEL DISPLAY
PRÉSENTOIR ROTATIF

Display feltöltéseinkkel kapcsolatban kérjük érdeklődjön vevőszolgálatainknál!



FELTÖLTÉSI JAVASLAT
PRESENTATION SUGGESTION
SUGGESTION DE PRÉSENTATION

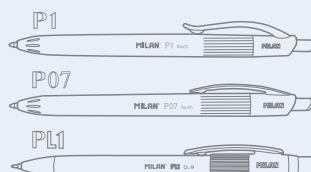

KAPACITÁS · CAPACITY · CAPACITÉ

154u.

ÜRES DISPLAY
EMPTY DISPLAY
PRÉSENTOIR VIDE

60,5 x 23,8 x 30 cm · 1,87 kg

1 unit · 2,37 kg

ZVM10236



8411574108870

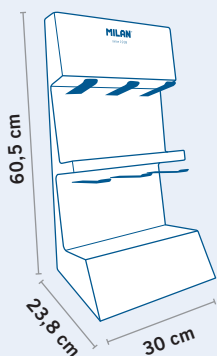

FORGÓ ÁLLVÁNY
SWIVEL DISPLAY
PRÉSENTOIR ROTATIF

ÜRES DISPLAY
EMPTY DISPLAY
PRÉSENTOIR VIDE

52 x 20,5 x 20 cm · 1,27 kg

1 unit · 1,75 kg

176509



8411574047551

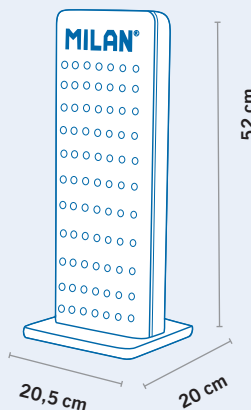

Display feltöltéseinkkel kapcsolatban kérjük érdeklődjön vevőszolgálatainknál!



KAPACITÁS · CAPACITY · CAPACITÉ



TARTALOM

CONTENT
CONTENU

16 x 28,5 x 33,5 cm · 2,75 kg

1 unit · 3,15 kg

99631801



8411574078883

1 Display 12u.

591292012

591291012

591293012

591293212

591295212

591293412

591296012

2 Displays 6u.

591211006

FELTÖLTÉSI JAVASLAT

PRESENTATION SUGGESTION
SUGGESTION DE PRÉSENTATION

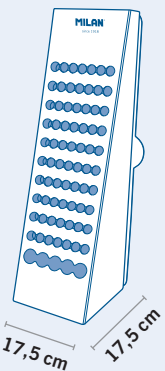

ZVM10184ES



8411574078395

ZVM10184CA



8411574078401

ZVM10184EN



8411574078418

ZVM10184PL



8411574078425

ZVM10184RO



8411574078432

NYELV SZERINTI VONALKÓDOK
CODE PER LANGUAGE CODE
SELON LANGUE

ZVM10184PT



8411574078449

ZVM10184RU



8411574078456

ZVM10184BG



8411574078463

ZVM10184KO



8411574078470

ZVM10184FR



8411574078487

ZVM10184HU



8411574078494



DISPLAYEK · DISPLAYS · PRÉSENTOIRS

Display feltöltéseinkkel kapcsolatban kérjük érdeklődjön vevőszolgálatainknál!



FORGÓ ÁLLVÁNY
SWIVEL DISPLAY
PRÉSENTOIR ROTATIF

ART



FELTÖLTÉSI JAVASLAT
PRESENTATION SUGGESTION
SUGGESTION DE PRÉSENTATION

15 x 3,2 x 7 cm · 46,6 gr

15 units · 0,80 kg

99302301



8411574104667

KAMPÓK · HOOKS · CROCHETS

15 cm



FORGÓ ÁLLVÁNY
SWIVEL DISPLAY
PRÉSENTOIR ROTATIF

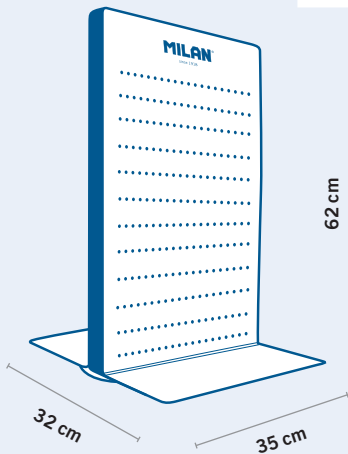

ÜRES DISPLAY
EMPTY DISPLAY
PRÉSENTOIR VIDE

62 x 35 x 32 cm · 7,04 kg

1 unit · 7,89 kg

99192302



8411574104650

TARTALOM

CONTENT
CONTENU

36 x 29 x 27 cm · 5,83 kg

1 unit · 6,36 kg

99662301



8411574104711

5u. 05B1612

6110212

4u. 05B1624

6110224

2u. 611612

611624

6u.

BWM10468 05B1150

BWM10351 05B1152

05B1110 05B1153

05B1115 05B1154

05B1118 05B1155

05B1119 05B1160

05B1120 05B1161

05B1125 05B1172

05B1126 05B1178

05B1128 05B1180

05B1131

05B1132

05B1137

05B1142

05B1143

05B1149



Display feltöltéseinkkel kapcsolatban kérjük érdeklődjön vevőszolgálatainknál!

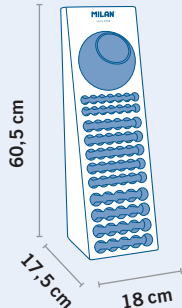

ÜRES DISPLAY
EMPTY DISPLAY
PRÉSENTOIR VIDE

60,5 x 18 x 17,5 cm · 1,05 kg

1 unit · 1,45 kg

99191717



8411574075790

TARTALOM · CONTENT · CONTENU

1 unit · 6,4 kg

99601801



8411574076070

| | | | |
|-----|---------|-----|---------|
| 1u. | 4401924 | 3u. | 4410924 |
| | | | 4420912 |

KAPACITÁS · CAPACITY · CAPACITÉ



24u.



30u.



14u.



20u.

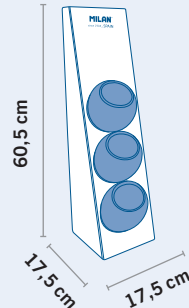

ÜRES DISPLAY
EMPTY DISPLAY
PRÉSENTOIR VIDE

60,5 x 17,5 x 17,5 cm · 1,05 kg

1 unit · 1,55 kg

ZVM10157



8411574070238

FELTÖLTÉSI JAVASLAT

PRESENTATION SUGGESTION
SUGGESTION DE PRÉSENTATION

TARTALOM · CAPACITY · CAPACITÉ



20u.



15u.



40u.

DISPLAYEK · DISPLAYS · PRÉSENTOIRS



KIEGÉSZÍTŐK · ACCESSORIES ·
ACCESSOIRES PG. > 272

8 KAMPÓVAL
HOOKS INCLUDED
CROCHETS INCLUSES **6** cm



Display feltöltéseinkkel kapcsolatban kérjük érdeklődjön vevőszolgálatainknál!

FELTÖLTÉSI JAVASLAT
PRESENTATION SUGGESTION
SUGGESTION DE PRÉSENTATION

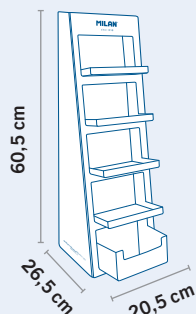

ÜRES DISPLAY
EMPTY DISPLAY
PRÉSENTOIR VIDE

60,5 x 26,5 x 20,5 cm · 1,15 kg

1 unit · 1,63 kg

4188D00



8411574021186

TARTALOM · CONTENT · CONTENU

33,5 x 28,5 x 17 cm · 6,98 kg

1 unit · 7,82 kg

4188DCONT



8411574070405

10u.

12u.

417190

4155400

85401

411501

85434

20u.

85435

87039

85433

24u.

85432

4111604

85501

419608

85301

30u.

85601

87000

FELTÖLTÉSI JAVASLAT
PRESENTATION SUGGESTION
SUGGESTION DE PRÉSENTATION

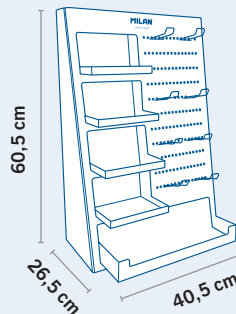

ÜRES DISPLAY
EMPTY DISPLAY
PRÉSENTOIR VIDE

60,5 x 40,5 x 26,5 cm · 2,10 kg

1 unit · 2,95 kg

4188DL00



8411574080862

TARTALOM · CONTENT · CONTENU

36 x 27,5 x 30 cm · 9,1 kg

1 unit · 10,1 kg

4188DLCONT



8411574080879

6u.

18u.

4155400

411260850

415508400

411261050

10u.

20u.

85501

85434

85401

85435

417190

85433

85301

85432

85601

87039

12u.

24u.

411501

419608

4111604

30u.

16u.

87000

411060801

411061001



Display feltöltéseinkkel kapcsolatban kérjük érdeklődjön vevőszolgálatainknál!



FELTÖLTÉSI JAVASLAT
PRESENTATION SUGGESTION
SUGGESTION DE PRÉSENTATION

FELTÖLTÉSI JAVASLAT
PRESENTATION SUGGESTION
SUGGESTION DE PRÉSENTATION

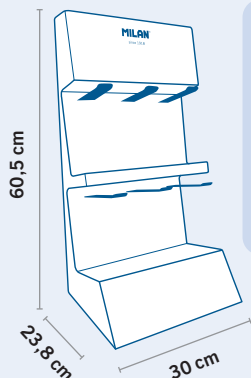

NYELV SZERINTI VONALKÓDOK
CODE PER LANGUAGE CODE SELON
LANGUE

ES ZVM10235ES
8411574091936

EN ZVM10235EN
8411574091950

FR ZVM10235FR
8411574092568

KAPACITÁS · CAPACITY · CAPACITÉ

| | |
|-------------|-------------|
| 5u. | 5u. |
| BWM10337B | BWM10348B |
| BWM10337Y | BWM10348P |
| 15u. | 15u. |
| BWM10338 | BWM10352B |

ÜRES DISPLAY
EMPTY DISPLAY
PRÉSENTOIR VIDE

60,5 x 23,8 x 30 cm · 1,87 kg

1 unit · 2,37 kg

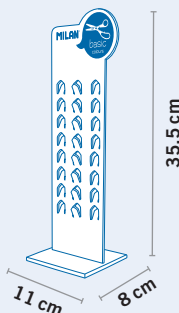

ÜRES DISPLAY
EMPTY DISPLAY
PRÉSENTOIR VIDE

60,5 x 17,5 x 17,5 cm · 1,05 kg

1 unit · 1,55 kg

ZVM10014
8411574054412

KAPACITÁS · CAPACITY · CAPACITÉ

ALAP SZÍNEK **24u.**

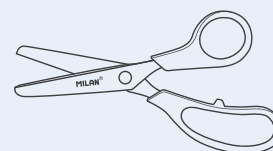

DISPLAYEK · DISPLAYS · PRÉSENTOIRS

BŐVÍTHETŐ
ADAPTER
ADAPTATEUR

PG. 272 >



BŐVÍTHETŐ
ADAPTER
ADAPTATEUR

PG. 272 >



Display feltöltéseinkkel kapcsolatban kérjük érdeklődjön vevőszolgálatainknál!



KARTON DISPLAY
CARDBOARD DISPLAY
PRÉSENTOIR EN CARTON

FELTÖLTÉSI JAVASLAT
PRESENTATION SUGGESTION
SUGGESTION DE PRÉSENTATION

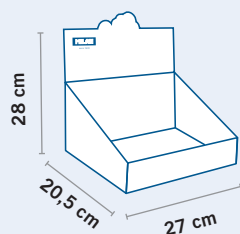

ÖSSZESZERELHETŐ ÜRES DISPLAY
MOUNTABLE EMPTY DISPLAY
PRÉSENTOIR VIDE, À MONTER

28 x 27 x 20,5 cm · 0,28 kg

ZVM10249



8411574100959

TARTALOM · CAPACITY · CAPACITÉ



24u.

116 gr - 4.1 oz

FELTÖLTÉSI JAVASLAT
PRESENTATION SUGGESTION
SUGGESTION DE PRÉSENTATION

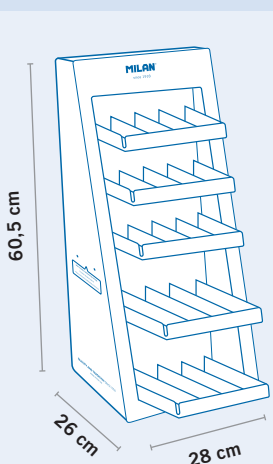

ÜRES DISPLAY
EMPTY DISPLAY
PRÉSENTOIR VIDE

60,5 x 26 x 28 cm · 1,65 kg

1 unit · 2,35 kg

ZVM10171



8411574074632

KAPACITÁS · CAPACITY · CAPACITÉ

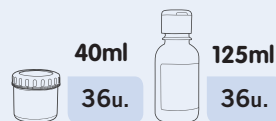

TARTALOM · CONTENT · CONTENU

48,5 x 35 x 31 cm · 17,30 kg

1 unit · 17,75 kg

99591801



8411574076056

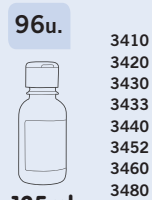

34 x 28,5 x 17 cm · 5,60 kg

1 unit · 5,75 kg

99591802



8411574076063

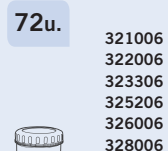

40ml

DISPLAYEK · DISPLAYS · PRÉSENTOIRS



FORGÓ ÁLLVÁNY
SWIVEL DISPLAY
PRÉSENTOIR ROTATIF



Display feltöltéseinkkel kapcsolatban kérjük érdeklődjön vevőszolgálatainknál!



BŐVÍTHETŐ
ADAPTER
ADAPTATEUR

PG. 272 >



BŐVÍTHETŐ
ADAPTER
ADAPTATEUR

PG. 272 >



DISPLAY
DISPLAY
PRÉSENTOIR

PG. 269 >

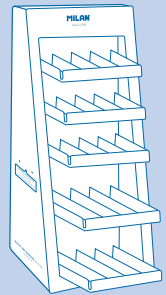

FELTÖLTÉSI JAVASLAT

PRESENTATION SUGGESTION
SUGGESTION DE PRÉSENTATION

7 REKESZES ÜRES DISPLAY.
MAXIMUM KAPACITÁS: 350 ECSET.

7-COMPARTMENT SWIVEL EMPTY
DISPLAY. MAXIMUM CAPACITY: 350
BRUSHES.

PRÉSENTOIR ROTATIF 7
COMPARTIMENTS VIDE. CAPACITÉ
MAXIMALE: 350 PINCEAUX.

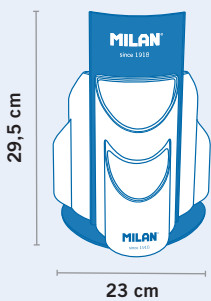

ÜRES DISPLAY
EMPTY DISPLAY
PRÉSENTOIR VIDE

29,5 x 23 x 23 cm · 0,95 kg

12 units · 1,30 kg

ZVM10162



8411574070290

TARTALOM · CONTENT · CONTENU

36 x 30 x 27,5 cm · 1,97 kg

1 unit · 2,40 kg

04002001



8411574070368

303u.

serie
101
series

38u.

serie
522
series

36u.

6u.

2 · 3

2 → 10

24u.

8u.

4 · 5 · 6 · 7

12

18u.

10

12u.

000 · 00 · 0

1 · 7 · 9 · 12

6u.

11 · 14 · 16 · 18

3u.

20 · 22 · 24

FELTÖLTÉSI JAVASLAT

PRESENTATION SUGGESTION
SUGGESTION DE PRÉSENTATION

2 REKESZES ÜRES DISPLAY.
MAXIMUM KAPACITÁS: 120 ECSET.

2-COMPARTMENT EMPTY DISPLAY.
MAXIMUM CAPACITY: 120 BRUSHES.

PRÉSENTOIR 2 COMPARTIMENTS VIDE.
CAPACITÉ MAXIMALE: 120 PINCEAUX.

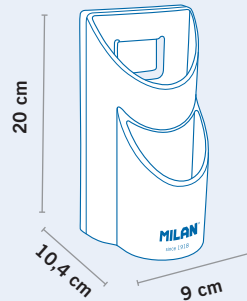

ÜRES DISPLAY
EMPTY DISPLAY
PRÉSENTOIR VIDE

20 x 10,4 x 9 cm · 0,12 kg

12 units · 2,15 kg

ZVM10160



8411574070276

TARTALOM · CONTENT · CONTENU

27,5 x 24 x 11,5 cm · 0,67 kg

1 unit · 0,80 kg

04002004



8411574070399

120u.

serie
311
series

12u. 0 → 6

6u. 7 → 12

27,5 x 24 x 11,5 cm · 0,63 kg

1 unit · 0,76 kg

04002003



8411574070382

75u.

serie
321
series

12u. 2 → 8

6u. 10 → 14

3u. 16 → 20

DISPLAYEK · DISPLAYS · PRÉSENTOIRS

Display feltöltéseinkkel kapcsolatban kérjük érdeklődjön vevőszolgálatainknál!

ÜRES DISPLAY
EMPTY DISPLAY
PRÉSENTOIR VIDE

21,3 x 17 x 14 cm · 1,20 kg

1 unit · 1,30 kg

393



8411574022978

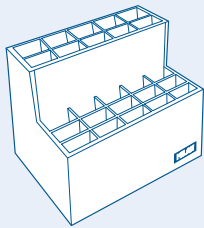

DISPLAY + FELTÖLTÉS
DISPLAY + CONTENT
PRÉSENTOIR + CONTENU

27 x 20,8 x 14 cm · 1,61 kg

1 unit · 2,20 kg

80487



8411574804871

DISPLAY + FELTÖLTÉS
DISPLAY + CONTENT
PRÉSENTOIR + CONTENU

25,5 x 25,5 x 20 cm · 2,45 kg

2 units · 5,30 kg

04000101237



8411574022015

serie
311
series

138u.

24u. 6

6u. 7, 9 → 12

12u. 0 → 5, 8

serie
101
series

237u.

12u. 000 → 1, 6 → 9

24u. 2 → 5

6u. 10 → 18

3u. 20 → 24

ÜRES DISPLAY
EMPTY DISPLAY
PRÉSENTOIR VIDE

17,3 x 13,5 x 11,3 cm · 0,66 kg

2 units · 1,45 kg

675



8411574035053

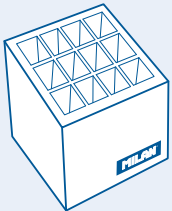

DISPLAY + FELTÖLTÉS
DISPLAY + CONTENT
PRÉSENTOIR + CONTENU

28 x 13,5 x 11 cm · 1,12 kg

1 unit · 1,70 kg

80485



8411574031680

DISPLAY + FELTÖLTÉS
DISPLAY + CONTENT
PRÉSENTOIR + CONTENU

25 x 13,5 x 11 cm · 1,02 kg

1 unit · 1,55 kg

80486



8411574804864

serie
321
series

66u.

12u. 2, 4, 6

6u. 8, 10, 12

3u. 14, 16, 18, 20

serie
311
series

108u.

12u. 1 → 6

6u. 7 → 12

ÜRES DISPLAY
EMPTY DISPLAY
PRÉSENTOIR VIDE

24 x 18,7 x 13 cm · 1,30 kg

1 unit · 1,40 kg

457



8411574030669

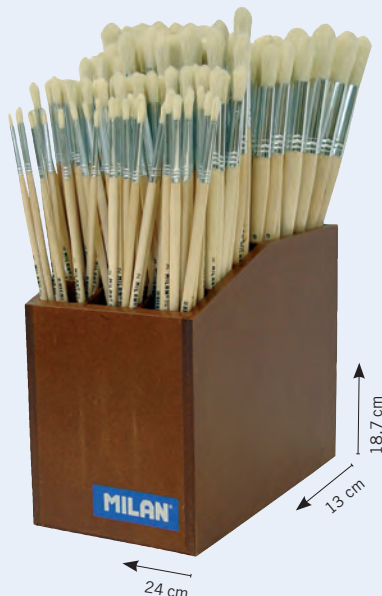
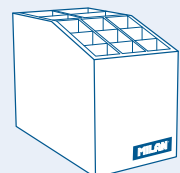

DISPLAY + FELTÖLTÉS
DISPLAY + CONTENT
PRÉSENTOIR + CONTENU

42 x 32,5 x 25 cm · 3,44 kg

1 unit · 4,80 kg

80373



8411574803737

DISPLAY + FELTÖLTÉS
DISPLAY + CONTENT
PRÉSENTOIR + CONTENU

42 x 32,5 x 25 cm · 3,45 kg

1 unit · 5 kg

80353



8411574803539

serie
522
series

144u.

12u. 1 → 12

serie
512
series

144u.

12u. 1 → 12

**DISPLAY KIEGÉSZÍTŐK · DISPLAY ACCESSORIES ·
ACCESSOIRES POUR PRÉSENTOIRS**

Display feltöltéseinkkel
kapcsolatban kérjük
érdeklődjön
vevőszolgálatainknál!

TÁLCA
TRAY
PLATEAU

19 x 15,5 x 8,4 cm · 23 gr

5 units · 1,25 kg

99422201



8411574100911

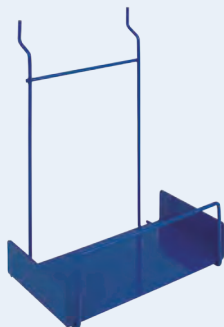

16 x 13,5 x 10,5 cm · 0,20 kg

10 units · 2,30 kg

99301402



8411574059936

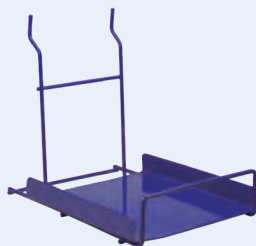

19 x 14 x 14,5 cm · 0,20 kg

10 units · 2,45 kg

99301401



8411574059929

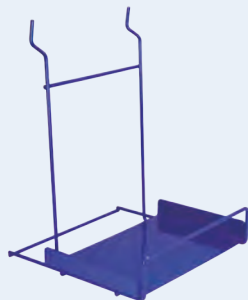

14,5 x 15,5 x 3 cm · 62 gr

15 units · 1,10 kg

99421301



8411574054207

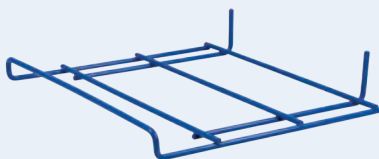

9,5 x 8,5 x 2,5 cm · 30 gr

20 units · 0,75 kg

99421201



8411574050575



20,2 x 11,2 x 7 cm · 72 gr

10 units · 0,81 kg

99302201



8411574100904

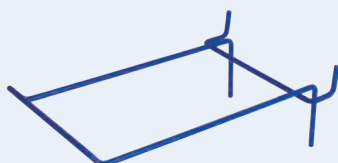

KAMPÓK
HOOKS
CROCHETS

15
cm

20
cm

33,5
cm

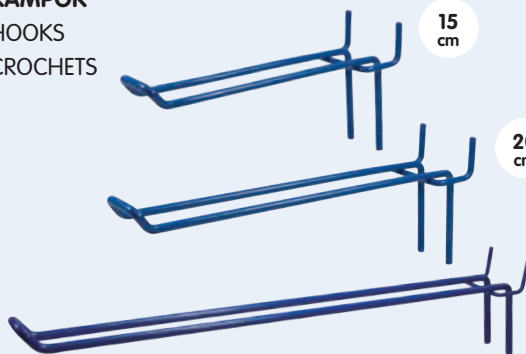

15
cm

15 x 3,2 x 7 cm · 46,6 gr

15 units · 0,80 kg

99302301



8411574104667

20
cm

20 x 7 x 4 cm · 56 gr

15 units · 1,05 kg

99301001



8411574039235

33,5
cm

33,5 x 6,5 x 3,5 cm · 124 gr

10 units · 1,40 kg

99421404



8411574056485

ÍRÓSZERTARTÓ
EMPTY CAN
BOÎTE VIDE



8 x 8 x 6,5 cm · 44 gr

50 units · 2,95 kg

ZPM10001



8411574049791

FÉM KIEGÉSZÍTŐ DISPLAY ÁLLVÁNYOKHOZ
METALLIC ADAPTER FOR DISPLAY STAND
ADAPTATEUR MÉTALLIQUE POUR PRÉSENTOIR

5 x 4,5 x 1,5 cm · 15 gr

25 units · 0,50 kg

99461701



8411574070429



MŰANYAG KIEGÉSZÍTŐ DISPLAY ÁLLVÁNYOKHOZ
PLASTIC ADAPTER FOR DISPLAY STAND
ADAPTATEUR EN PLASTIQUE POUR PRÉSENTOIR

9,7 x 7,52 x 2,5 cm · 0,30 gr

10 units · 0,45 kg

99461702



8411574070436



FÜZET DISPLAY · WOOD DISPLAY · PRÉSENTOIR BOIS

A FELHASZNÁLT FA FENN-
TARTHATÓ ÜLTETVÉNYEKRŐL
SZÁRMAZIK

WOOD FROM SUSTAINABLE
PLANTATIONS

BOIS ISSU DE
PLANTATIONS DURABLES

RAGASZTÁS- ÉS
MŰANYAG RÉSZEKTŐL
MENTES

NO ADHESIVES
OR PLASTIC PARTS
NE CONTIENT PAS
D'ADHÉSIFS NI D'ÉLÉMENTS
EN PLASTIQUE

Display feltöltéseinkkel
kapcsolatban kérjük
érdeklődjön
vevőszolgálatainknál!

NEW!

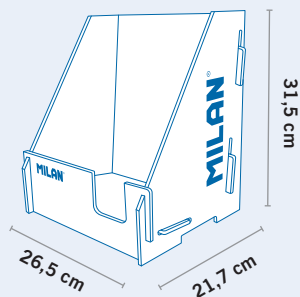

ÖSSZEÁLLÍTHATÓ ÜRES DISPLAY
MOUNTABLE EMPTY DISPLAY
PRÉSENTOIR VIDE, À MONTER

31,5 x 61,5 x 21,7 cm · 0,54 kg

1 unit · 0,76 kg

99192401



8411574108740

TARTALOM · CAPACITY · CAPACITÉ



18u.



8u.

FELTÖLTÉSI JAVASLAT
PRESENTATION SUGGESTION
SUGGESTION DE PRÉSENTATION

ÖSSZESZERELÉSI ÚTMUTATÓVAL
ASSEMBLY INSTRUCTIONS INSIDE
INSTRUCTIONS DE MONTAGE INTÉRIEUR



FORGÓ ÁLLVÁNY
SWIVEL DISPLAY
PRÉSENTOIR ROTATIF

FELTÖLTÉSI JAVASLAT
PRESENTATION SUGGESTION
SUGGESTION DE PRÉSENTATION

Display feltöltéseinkkel kapcsolatban kérjük érdeklődjön vevőszolgálatainknál!



FORGÓ ÁLLVÁNY
SWIVEL DISPLAY
PRÉSENTOIR ROTATIF



HALMOZHATÓ DISPLAY
STACKABLE DISPLAY
PRÉSENTOIR EMPILABLE

KAPACITÁS · CAPACITY
CAPACITÉ

POCKET
paperbooks

28u.

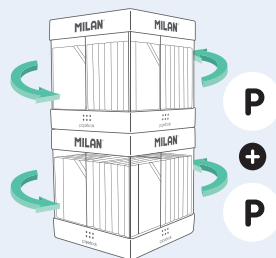

ÜRES DISPLAY
EMPTY DISPLAY
PRÉSENTOIR VIDE

24,7 x 24,2 x 24,2 cm · 1,50 kg

1 unit · 2,15 kg

99191528



8411574062455

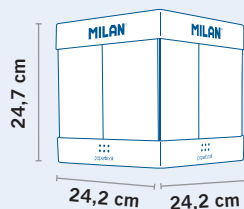

KAPACITÁS · CAPACITY
CAPACITÉ

MEDIUM
paperbooks

60u.

ÜRES DISPLAY
EMPTY DISPLAY
PRÉSENTOIR VIDE

86,5 x 24,2 x 24,2 cm · 6,30 kg

1 unit · 8,10 kg

99191411



8411574059516

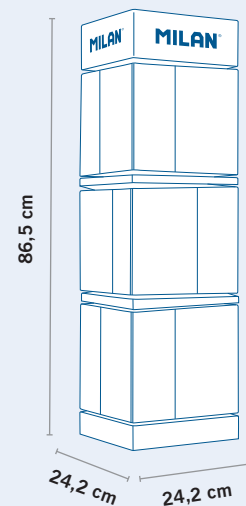

KULACS DISPLAY · WOOD DISPLAY · PRÉSENTOIR BOIS

A FELHASZNÁLT FA FENN-
TARTHATÓ ÜLTETVÉNYEKRŐL
SZÁRMAZIK

WOOD FROM SUSTAINABLE
PLANTATIONS

BOIS ISSU DE
PLANTATIONS DURABLES

RAGASZTÁS- ÉS MŰANYAG
RÉSZEKTŐL MENTES

NO ADHESIVES
OR PLASTIC PARTS

NE CONTIENT PAS
D'ADHÉSIFS NI D'ÉLÉMENTS
EN PLASTIQUE

Az újrafelhasználható
palackok használata
hozzájárul a
műanyagfogyasztás
csökkentéséhez.

The use of reusable bottles
contributes to reducing
the plastic consumption of
single-use disposable bottles.

L'utilisation de bouteilles
réutilisables contribue
à réduire la consommation
de plastique à usage unique
des bouteilles jetables.

Display feltöltéseinkkel
kapcsolatban kérjük
érdeklődjön
vevőszolgálatainknál!

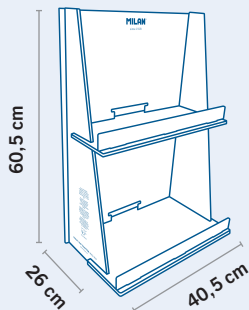

ÖSSZEÁLLÍTHATÓ ÜRES DISPLAY
MOUNTABLE EMPTY DISPLAY
PRÉSENTOIR VIDE, À MONTER

60,5 x 42,5 x 2 cm · 1,38 kg

1 unit · 1,70 kg

ZVM10242



8411574098980

25u.

FELTÖLTÉSI JAVASLAT
PRESENTATION SUGGESTION
SUGGESTION DE PRÉSENTATION

ÖSSZESZERELÉSI
ÜTMUTATÓVAL

ASSEMBLY
INSTRUCTIONS INSIDE
INSTRUCTIONS DE
MONTAGE INTÉRIEUR

KAPACITÁS · CAPACITY · CAPACITÉ



40u.

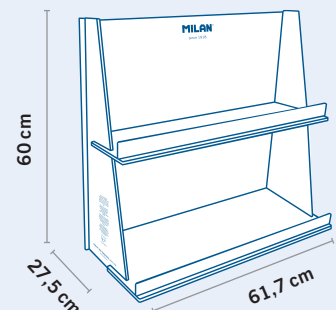

ÖSSZEÁLLÍTHATÓ ÜRES DISPLAY
MOUNTABLE EMPTY DISPLAY
PRÉSENTOIR VIDE, À MONTER

61,7 x 60 x 27,5 cm · 1,68 kg

1 unit · 2,30 kg

ZVM10254



8411574104599

Display feltöltéseinkkel kapcsolatban kérjük érdeklődjön vevőszolgálatainknál!





FELTÖLTÉSI JAVASLAT
PRESENTATION SUGGESTION
SUGGESTION DE PRÉSENTATION

FORGÓ ÁLLVÁNY
SWIVEL DISPLAY
PRÉSENTOIR ROTATIF

KAPACITÁS · CAPACITY · CAPACITÉ

75u. 15 cm

  x 15

FELTÖLTÉSI JAVASLAT
PRESENTATION SUGGESTION
SUGGESTION DE PRÉSENTATION

ÜRES DISPLAY
EMPTY DISPLAY
PRÉSENTOIR VIDE

62 x 35 x 32 cm · 7,04 kg

 1 unit · 7,89 kg

ZVM10238



8411574095507

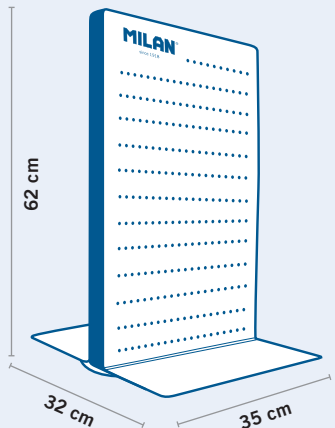

ÜRES DISPLAY
EMPTY DISPLAY
PRÉSENTOIR VIDE

61 x 32 x 23 cm · 2,69 kg

 1 unit · 3,41 kg

ZVM99191001



8411574037217

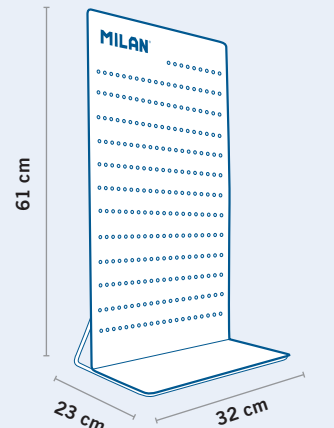

DISPLAYEK · DISPLAYS · PRÉSENTOIRS



Display feltöltéseinkkel kapcsolatban kérjük érdeklődjön vevőszolgálatainknál!



FELTÖLTÉSI JAVASLAT
PRESENTATION SUGGESTION
SUGGESTION DE PRÉSENTATION



FORGÓ ÁLLVÁNY
SWIVEL DISPLAY
PRÉSENTOIR ROTATIF

FELTÖLTÉSI JAVASLAT
PRESENTATION SUGGESTION
SUGGESTION DE PRÉSENTATION



FORGÓ ÁLLVÁNY
SWIVEL DISPLAY
PRÉSENTOIR ROTATIF

ÜRES DISPLAY
EMPTY DISPLAY
PRÉSENTOIR VIDE

190 x 45,5 x 37 cm · 20,1 kg

1 unit · 25,7 kg

99191201



8411574046493

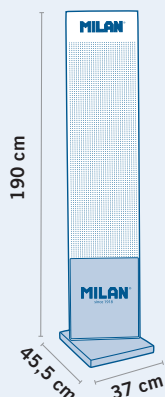

ÜRES DISPLAY
EMPTY DISPLAY
PRÉSENTOIR VIDE

160 x 70 x 37 cm · 28 kg

1 unit · 30,6 kg

99192110



8411574095514

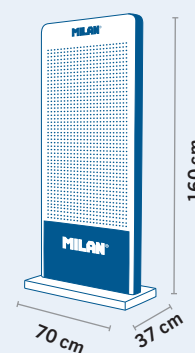



Display feltöltéseinkkel kapcsolatban kérjük érdeklődjön vevőszolgálatainknál!



FELTÖLTÉSI JAVASLAT
PRESENTATION SUGGESTION
SUGGESTION DE PRÉSENTATION



BEÉPÍTETT VILÁGÍTÁSSAL
DISPLAY WITH LIGHT
PRÉSENTOIR AVEC LUMIÈRE

FELTÖLTÉSI JAVASLAT
PRESENTATION SUGGESTION
SUGGESTION DE PRÉSENTATION



BEÉPÍTETT VILÁGÍTÁSSAL
DISPLAY WITH LIGHT
PRÉSENTOIR AVEC LUMIÈRE

**LED
12V**

ÜRES DISPLAY
EMPTY DISPLAY
PRÉSENTOIR VIDE

184,5 x 75,5 x 40,5 cm · 29,3 kg

1 unit · 34,7 kg

99191716FL



8411574087755

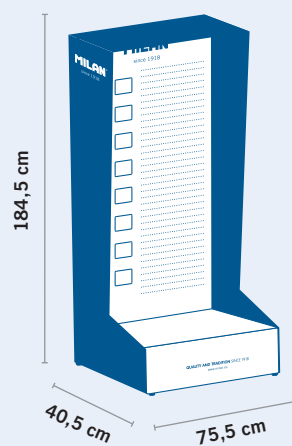

**LED
12V**

ÜRES DISPLAY
EMPTY DISPLAY
PRÉSENTOIR VIDE

184,5 x 75,5 x 40,5 cm · 29,3 kg

1 unit · 34,7 kg

99191716L



8411574087762

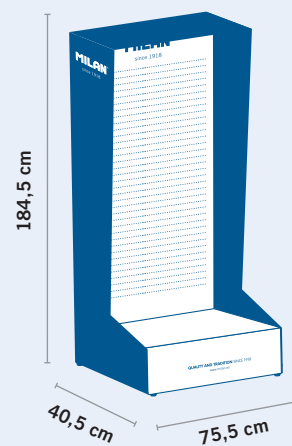

DISPLAYEK · DISPLAYS · PRÉSENTOIRS

Display feltöltéseinkkel kapcsolatban kérjük érdeklődjön vevőszolgálatainknál!



FELTÖLTÉSI JAVASLAT
PRESENTATION SUGGESTION
SUGGESTION DE PRÉSENTATION

FELTÖLTÉSI JAVASLAT
PRESENTATION SUGGESTION
SUGGESTION DE PRÉSENTATION

ÜRES DISPLAY
EMPTY DISPLAY
PRÉSENTOIR VIDE

184,5 x 75,5 x 40,5 cm · 25 kg

1 unit · 36,9 kg

99191716
8411574074649

ÜRES DISPLAY
EMPTY DISPLAY
PRÉSENTOIR VIDE

183 x 151 x 41,5 cm · 67,6 kg

1 unit · 74 kg

99191412
8411574059523